

**Accu-Med**<sup>®</sup>  
Instrument Co.

[www.accumedinstrument.com](http://www.accumedinstrument.com)

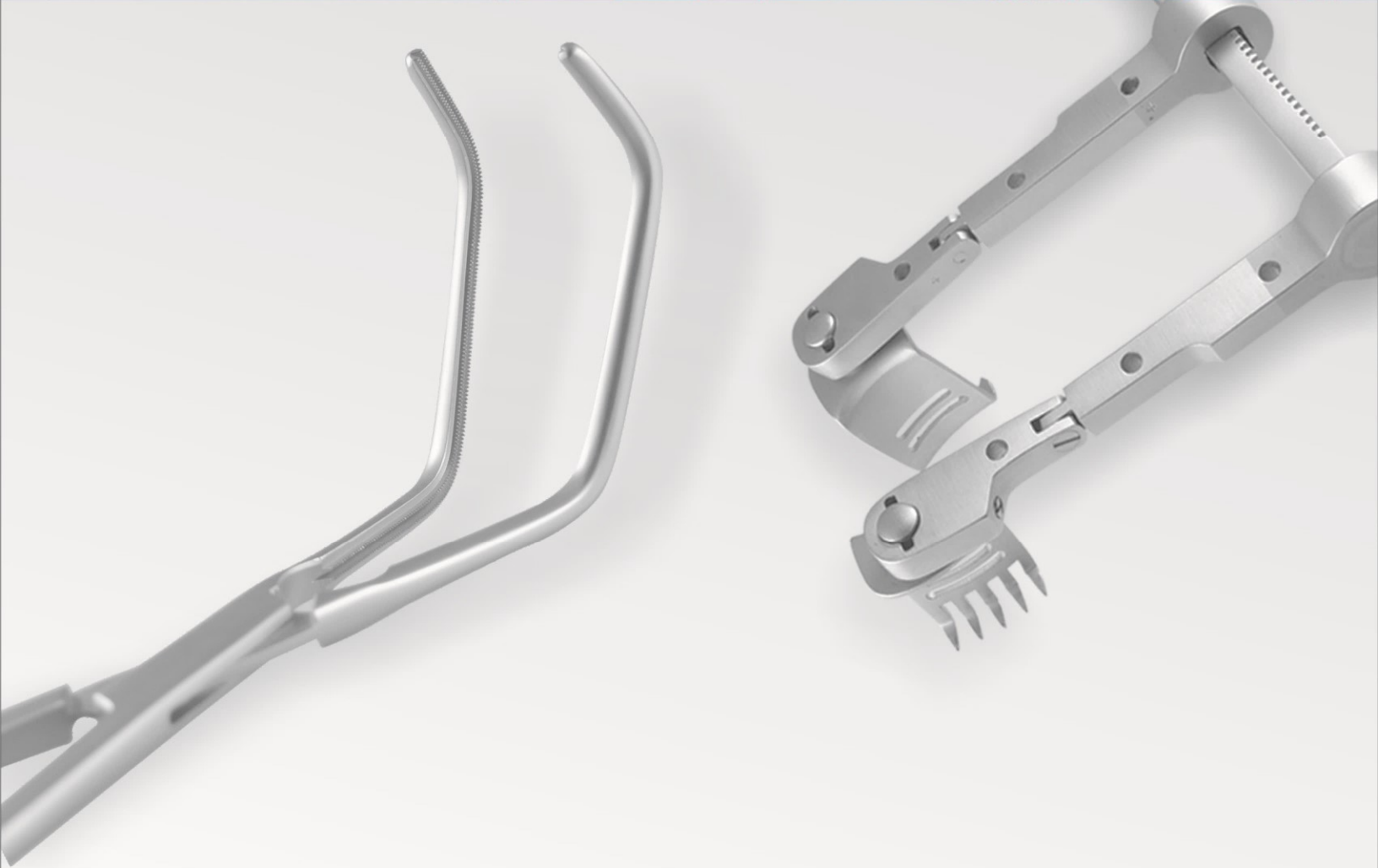

**SURGICAL** Catalogue  
[www.accumedinstrument.com](http://www.accumedinstrument.com)



**Scalpel Handle No. 3**  
01-1001.03



**Scalpel Handle No. 3K**  
01-1002.03



**Scalpel Handle No. 4**  
01-1003.04



**Scalpel Handle No. 4**  
01-1004.04



**Scalpel Handle No. 7**  
01-1005.007



**Scalpel Handle No. 7K**  
01-1006.7K



**Collin No. 8**  
01-1007.08



**Collin No. 9**  
01-1008.9



**Double handle**  
Number 3 + Number 4  
01-1009.34



**Scalpel Handle**  
No. 3L  
01-1010.03



**Scalpel Handle**  
No. 4L  
01-1011.04

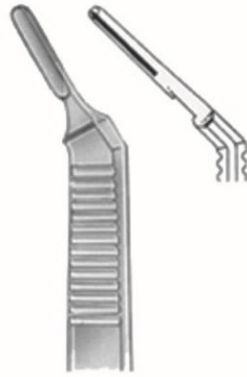

**3L**  
01-1012.03

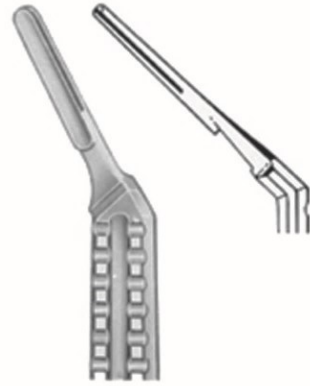

**4L**  
01-1013.04



**Scalpel Plastic Handle**  
No. 5  
01-1014.13



**Scalpel Handle**  
No. 5  
01-1015.05  
15cm/6"



**Scalpel Handle**  
No. 5A  
01-0016.15  
15cm/6"



**Scalpel Handle**  
01-1017.11  
11.4cm/4 1/2"



**Scalpel Handle**  
01-1018.16  
16cm/6 1/4"



**Scalpel Handle**  
01-1019.12  
12.7cm/5"



**Scalpel Handle**  
01-1020.11  
11cm/4 1/4"



**Scalpel Handle**  
01-1021.12  
12.7cm/5"



**Scalpel Handle**  
01-1022.13  
13.5cm/5 1/4"



**Scalpel Handle**  
01-1023.12  
12cm/4 3/4"



17cm/6 3/4"



**Fig. 01**  
01-1024.01



**Fig. 02**  
01-1024.02



**Fig. 03**  
01-1024.03



**Fig. 04**  
01-1024.04



**Fig. 05**  
01-1024.05



**Fig. 06**  
01-1024.06



**Fig. 07**  
01-1024.07



**Fig. 08**  
01-1024.08



**Fig. 09**  
01-1024.09

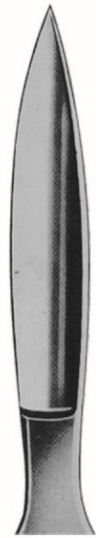

**Fig. 10**  
01-1024.10



17cm/6 3/4"



**Fig. 01**  
01-1025.01



**Fig. 02**  
01-1025.02



**Fig. 03**  
01-1025.03



**Fig. 04**  
01-1025.04



**Fig. 05**  
01-1025.05



**Fig. 06**  
01-1025.06



**Fig. 07**  
01-1025.07



**Fig. 08**  
01-1025.08



**Fig. 09**  
01-1025.09



**Fig. 10**  
01-1025.10



**Fig. 11**  
01-1025.11



**Fig. 12**  
01-1025.12



**Fig. 13**  
01-1025.13



**Fig. 14**  
01-1025.14



**Fig. 15**  
01-1025.15



**Fig. 16**  
01-1025.16



**Fig. 18**  
01-1025.18



**Fig. 27**  
01-1025.27



**Fig. 38**  
01-1025.-38



**Fig. 40**  
01-1025.40



**Fig. 46**  
01-1025.46



**Fig. 61**  
01-1025.61



**Fig. 63**  
01-1025.63



**Dieffenbach**  
17cm/6 3/4"



**Fig. 01**  
01-1026.01



**Fig. 02**  
01-1026.02



**Fig. 03**  
01-1026.03



**Fig. 04**  
01-1026.04



**Fig. 05**  
01-1026.05



**Fig. 06**  
01-1026.06



**Fig. 07**  
01-1026.07



**Fig. 08**  
01-1026.08



**Fig. 09**  
01-1026.09



**Fig. 15**  
01-1026.15



**Fig. 16**  
01-1026.16

# General Instruments

Operating knives  
Betriebssystem Messer

Couteaux d'exploitation  
Cuchillos de funcionamiento



**Bergmann**  
01-1027.01  
14cm/5 3/4"



**Fig. 02**  
01-1027.02



**Fig. 03**  
01-1027.03



**Fig. 04**  
01-1027.04



**Deiffenbach**  
13cm/5 1/4"



**Fig. 01**  
01-1028.01



**Fig. 02**  
01-1028.02



**Fig. 03**  
01-1028.03



**Fig. 04**  
01-1028.04



**Fig. 05**  
01-1028.05



**Fig. 06**  
01-0028-06



**Fig. 07**  
01-1028.07



**Fig. 08**  
01-1028.08



**Fig. 09**  
01-1028.09



**Fig. 10**  
01-1028.10



**Fig. 11**  
01-1028.11



**Fig. 12**  
01-1028.12

# General Instruments

Fistula Knives  
Fistula Messer

Couteaux fistule  
Cuchillos fistula



**Simon**  
23.5cm/9 1/4"



**Fig.01**  
01-1029.01



**Fig.02**  
01-1029.02



**Fig.03**  
01-1029.03



**Fig.04**  
01-1029.04



**Ulrich**  
22.5cm/9"



**Fig.01**  
01-1030.01



**Fig.02**  
01-1030.02



**Fig.03**  
01-1030.03



**Simon**  
20cm/8"



**Fig.01**  
01-1031.01



**Fig.02**  
01-1031.02



**Fig.03**  
01-1031.03



**Fig.04**  
01-1031.04



01-1032.01  
7.5cm/3"



01-1032.02  
8cm/3 1/2"

**Razors**

# General Instruments

Amputation Knives  
Amputation Messer

Couteaux amputation  
Cuchillos de amputación



Flap knife  
Klappe Messer  
couteau rabat  
solapa cuchillo

Phalangeal knife  
phalangealen Messer  
couteau phalangienne  
cuchillo de falange

Interosseous knife  
interossea Messer  
couteau interosseux  
cuchillo interóseo

Length of blades  
Länge der Schaufeln  
Longueur des pales  
Longitud de las palas

**Liston**

**Catlin**

**Langenbeck**

| cm   | in    |            |            |            |
|------|-------|------------|------------|------------|
| 9.5  | 3 3/4 | 01-1033.09 |            | 01-1037.09 |
| 11.0 | 4 1/2 | 01-1033.11 |            | 01-1038.11 |
| 12.0 | 4 3/4 | 01-1033.12 |            |            |
| 13.0 | 5     | 01-1033.13 |            | 01-1036.12 |
| 15.0 | 6     | 01-1033.15 |            |            |
| 16.0 | 6 1/4 | 01-1033.16 |            | 01-1035.16 |
| 17.0 | 6 3/4 |            | 01-1034.17 |            |
| 19.0 | 7 1/2 | 01-1033.19 |            | 01-1035.19 |
| 20.0 | 8     |            | 01-1034.20 |            |
| 22.0 | 8 3/4 | 01-1033.22 |            | 01-1035.22 |

# General Instruments

Resection, Brains, Post Mortem  
Resektion, Brains, Post Mortem

Résection, Brains, Post Mortem  
La resección, Brains, Post Mortem



## General Instruments

Cartilage Knives  
Knorpel Messer

Couteaux du cartilage  
Cuchillos de cartilago



01-1041.17  
17.5 cm/7"



01-1042.17  
17.5 cm/7"



**Virchow**  
01-1043.22  
22 cm/8 1/2"  
90mm



**Virchow**  
01-1044.22  
22 cm/8 1/2"  
90mm



01-1045.21  
21 cm/8 1/4"  
70mm

# General Instruments

Autopsy Knives  
Autopsieskalpelle

Couteaux d'autopsie  
Cuchillos de la autopsia



**Virchow**  
01-1046.25  
25 cm/10"



**Virchow**  
01-1047.25  
25 cm/10"



**Virchow**  
01-1048.25  
25 cm/10"



**Virchow**  
01-1049.25  
25 cm/10"  
90mm



**Virchow**  
01-1050.26  
26 cm/10 1/4"  
120mm



**Virchow**  
01-1051.27  
27 cm/10 1/2"  
150mm

# General Instruments

Autopsy Knives and Chisels  
Autopsy Messern und Meißeln

Cuchillos de la autopsia y cinceles  
Couteaux et ciseaux d'autopsie



**Brunetti**  
01-1052.28  
28.5cm/11 1/4"



**Brunetti**  
01-1053.28  
28.5cm/11 1/4"



01-1054.13  
13cm/5"

Osteotome  
Osteotom  
ostéotome  
osteotomo



**Brunetti**  
01-1055.27  
27cm/10 1/2"



01-1056.22  
22cm/8 3/4"

Rachiotome



01-1057.14  
14cm/5 1/2"

## General Instruments

Blow Pipes and Post Mortem Set  
Blasrohre und Post Mortem Set

Chalumeaux et Set Mortem Message  
Sopletes y Set Mortem mensaje



01-1059.67



01-1060.68



01-1061.69



01-1058.57

Post mortem set in wooden case.

Consisting of:

- 2 Dissecting knives. 01-1024.03
- 1 Dissecting knife. 01-1024-07
- 1 post mortem knife. 01-1047-25
- 1 Cartilage knife. 01-1042-17
- 1 Scissors with probe-end, straight,  
13 cm long (5 $\frac{1}{8}$ " ) 01-1060-13
- 1 Dressing forceps,  
13 cm long (5 $\frac{1}{8}$ " ) 03-1550-13
- 1 Charrier 30 cm/12" 12-2066-30
- 1 Metal hammer. 12-2123-19
- 1 Osteotome. 01-1054-13
- 2 Dissecting hooks, double, 01-0063-06
- 2 Blow pipes, double, 01-1061-69
- 2 Probes with olive-ends,  
13 cm long (5") 07-1372-13
- 3 suture needles, assorted sizes.



01-1062.07  
7cm



01-1063.06  
6.5cm



01-1064.10  
10.5cm

# General Instruments

Skin Grafting Knives  
Hauttransplantation Messer

Couteaux greffes de peau  
Injertos de Cuchillos



**Schink**  
01-1065.30  
30cm/12"



**Humby**  
01-1068.30  
30cm/12"



**Thiersch**  
01-1066.20  
20cm/8"



**Spare Blade**  
01-1067.75



**Spare Blade**  
01-1069.76

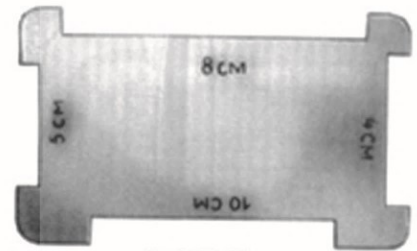

01-1070.77

# General Instruments

Razor Blade Breakers  
Razor Blade Breakers

Breakers de lames de rasoir  
Breakers Razor blade



**Treubnan-Chris**  
01-1071.09  
9cm/3 1/2"



**Treubnan-Chris**  
01-1072.09  
9cm/3 1/2"

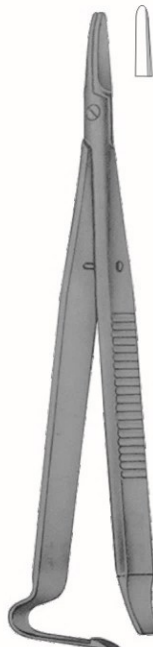

01-1073.11  
11cm/4 1/2"



**Castreviejo**  
01-1074.13  
13cm/5 1/4"



**Castreviejo**  
01-1075.18  
18cm/7"

## General Instruments

Dissecting Set  
Dissecting Set

Trousse à dissection  
La disección de Ajuste

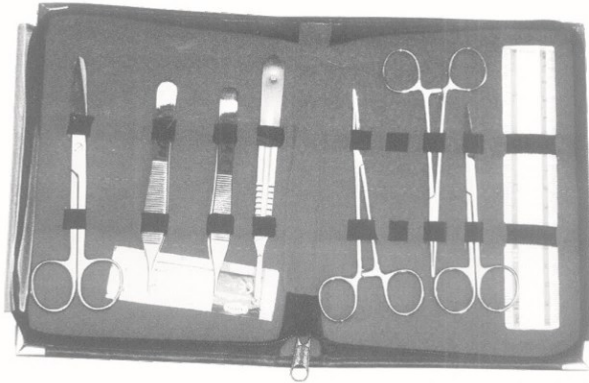

01-1076.83  
Dissecting Set  
Contains 9 Instruments

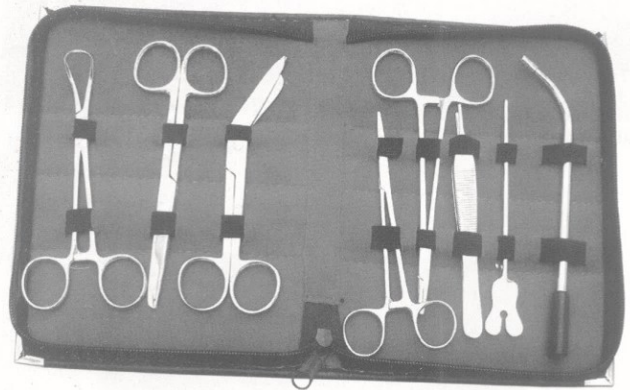

01-1077.84  
Advance Anatomy Dissecting Set  
Contains 8 Instruments

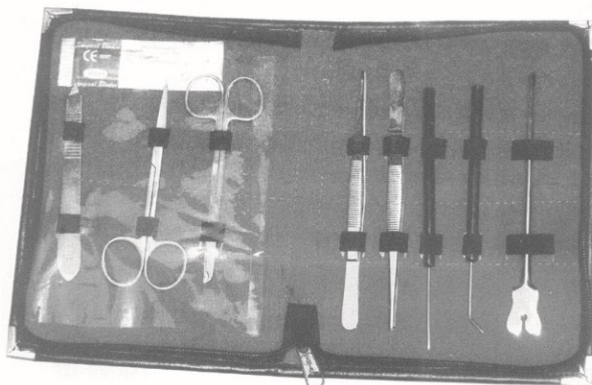

01-1078.85  
Dissecting Set  
Contains 9 Instruments



01-1079.86  
Professional Dissecting Set  
Contains 8 Instruments

# General Instruments

Blow Pipes and Post Mortem Set  
Blasrohre und Post Mortem Set

Chalumeaux et Post Mortem Set  
Sopletes y Juegos de Post Mortem

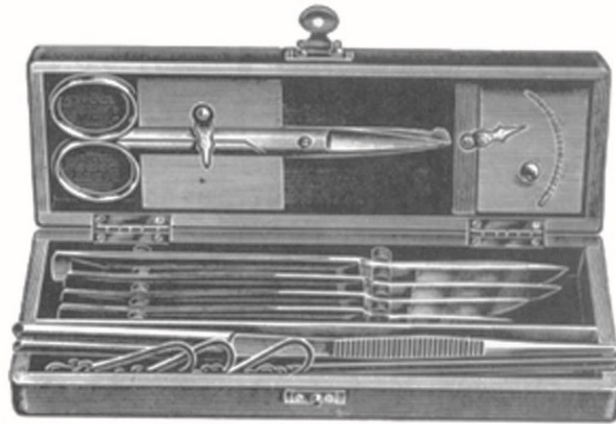

- 01-1080.13  
Dissecting set  
in wooden case, consisting of:  
1 Dissecting knife 3"  
1 Dissecting knife 8"  
1 Cartilage knife 25"  
1 Scissors with probe-end,  
13 cm long (5")  
1 Dressing forceps,  
13 cm long (5")  
1 Tissue forceps,  
13 cm long (5")  
1 Microscopic forceps,  
10.5 cm long (4 1/4")  
1 Probe with eye,  
13 cm long (5")  
1 Dissecting hook, double

- 01-1081.15  
Dissecting set  
in wooden case, consisting of:  
1 Dissecting knife 3"  
1 Dissecting knife 5"  
1 Dissecting knife 8"  
1 Cartilage knife 25"  
1 Scissors with probe-end,  
13 cm long (5")  
1 Dressing forceps,  
13 cm long (5")  
1 Triple chain hook  
1 Blow pipe, double



- 01-1082.10  
Dissecting set  
in plastic case, consisting of:  
1 Dissecting knife 3"  
1 Dissecting knife 5"  
1 Dissecting knife 8"  
1 Probe, Olive ends, 13 cm long (5")  
1 Grooved Director, 13 cm long (5")  
1 Dissecting hook, double  
1 Scissors with probe-end, 13cm long (5 1/8")  
1 Dressing forceps,  
13 cm long(5")  
1 Blow pipe, double



|  |   |
|--|---|
| <p><b>Straight</b><br/>02-0090-14</p> <p>Striaght<br/>striaght<br/>striaght<br/>striaght</p> | <p><b>Curved</b><br/>02-0091-14</p> <p>Curved<br/>Gebogene<br/>courbé<br/>Curvo</p> |
|--|---|



|  |   |
|--|---|
| <b>Mayo</b>  |   |
| <p>02-0092-14 14cm/5½"</p> <p>02-0092-17 17.0cm/6¾"</p> <p>02-0092-23 23.0cm/9"</p> <p>Striaght<br/>striaght<br/>striaght<br/>striaght</p> | <p>02-0093-14 14cm/5½"</p> <p>02-0093-17 17.0cm/6¾"</p> <p>02-0093-23 23.0cm/9"</p> <p>Curved<br/>Gebogene<br/>courbé<br/>Curvo</p> |



|   |  |
|---|--|
| <b>Mayo-Stillle</b>   |  |
| <p>02-0094-15 15.0cm/6"</p> <p>02-0094-17 17.0cm/6¾"</p> <p>Striaght<br/>striaght<br/>striaght<br/>striaght</p> | <p>02-0095-15 15.0cm/6"</p> <p>02-0095-17 17.0cm/6¾"</p> <p>Curved<br/>Gebogene<br/>courbé<br/>Curvo</p> |



|   |  |
|---|--|
| <b>Lexer</b>  |  |
| <p>02-0096-16 16cm/6¼"</p> <p>Striaght<br/>striaght<br/>striaght<br/>striaght</p> | <p>02-0097-16 16cm/6¼"</p> <p>Curved<br/>Gebogene<br/>courbé<br/>Curvo</p> |



|   |  |
|---|--|
| <b>Baby-Metzenbaum</b>  |  |
| <p>02-0098-11 11.5cm/4½"</p> <p>Striaght<br/>striaght<br/>striaght<br/>striaght</p> | <p>02-0099-11 11.5cm/4½"</p> <p>Curved<br/>Gebogene<br/>courbé<br/>Curvo</p> |



|  |   |
|--|---|
| <b>Metzenbaum</b>  |   |
| <p>02-0100-14 14 cm/5½"</p> <p>Striaght<br/>striaght<br/>striaght<br/>striaght</p> | <p>02-0101-14 14 cm/5½"</p> <p>Curved<br/>Gebogene<br/>courbé<br/>Curvo</p> |



|   |  |  |
|---|--|--|
| <b>Metzenbaum-Fine</b>  |  |  |
| <p>02-0102-14 14cm/5¾"</p> <p>02-0102-18 18cm/7"</p> <p>02-0102-20 20cm/8"</p> <p>02-0102-23 23cm/9"</p> <p>Striaght<br/>striaght<br/>striaght<br/>striaght</p> | <p>02-0103-14 14cm/5¾"</p> <p>02-0103-18 18cm/7"</p> <p>02-0103-20 20cm/8"</p> <p>02-0103-23 23cm/9"</p> <p>Curved<br/>Gebogene<br/>courbé<br/>Curvo</p> |  |

# General Instruments

Supercut Scissors  
Ciseaux Supercut

Ciseaux Supercut  
Tijeras Supercut



**Siebold**  
02-0104-24  
24 cm/9½"



**Sims**  
02-0105-20 20 cm/8"  
02-0105-23 23 cm/9"  
02-0106-20  
02-0106-23  
Straight  
straight  
straight  
straight  
Curved  
Gebogene  
courbé  
Curvo



**Reynolds**  
02-0107-15 15 cm/6"  
02-0108-15  
Straight  
straight  
straight  
straight  
Curved  
Gebogene  
courbé  
Curvo

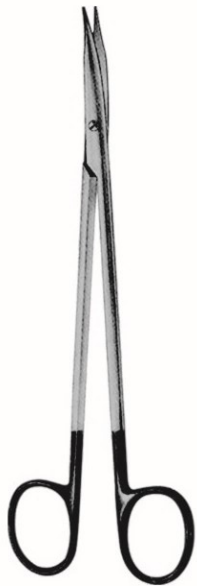

**Jameson**  
02-0109-15 15 cm/6"  
02-0109-18 18 cm/7"



02-0110-11 11.5 cm/4½"  
02-0111-11  
Straight  
straight  
straight  
straight  
Curved  
Gebogene  
courbé  
Curvo



**Plastic Surgery**  
02-0112-12 12 cm/4¾"  
02-0113-12  
Straight  
straight  
straight  
straight  
Curved  
Gebogene  
courbé  
Curvo



**Wagner**  
02-0114-12 12 cm/4¾"  
02-0115-12  
Straight  
straight  
straight  
straight  
Curved  
Gebogene  
courbé  
Curvo



**Fomon**  
02-0116-13  
13 cm/5"



**Fomon**  
02-0117-13  
13 cm/5"



**Cottle**  
02-0118-16  
16cm/6 1/4"



**Heymann**  
02-0119-18  
18 cm/7"



**Braun-Stadler**  
02-0120-14 14 cm/5 1/2"  
02-0120-22 22 cm/8 3/4"



**Lister**  
02-0121-14 14 cm/5 1/2"  
02-0121-18 18 cm/7"  
02-0121-20 20 cm/8"



**Stevens**  
Straight 02-0122-11 11.5 cm/4 1/2"  
Curved 02-0123-11  
Curved Gebogene  
straight courbé  
straight Curvo

# General Instruments

Supercut Scissors  
Ciseaux Supercut

Ciseaux Supercut  
Tijeras Supercut



02-0124-11  
11.5 cm/4 1/2"



02-0125-14  
14 cm/5 1/2"



**Reynolds**  
02-0126-13  
13 cm/5"



02-0127-17  
17 cm/6 3/4"



**Potts-Smith**  
19 cm/7 1/2"



25°  
02-0128-19



45°  
02-0129-19



60°  
02-0130-19



Standard  
Fig. 1

|      |        |            |
|------|--------|------------|
| 10.0 | cm/4"  | 02-0131-10 |
| 11.5 | cm/4½" | 02-0131-11 |
| 13.0 | cm/5"  | 02-0131-13 |
| 14   | cm/5½" | 02-0131-14 |
| 15   | cm/6"  | 02-0131-15 |
| 16.0 | cm/6¼" | 02-0131-16 |
| 18.0 | cm/7"  | 02-0131-18 |
| 20.0 | cm/8"  | 02-0131-20 |



Standard  
Fig. 2

|            |
|------------|
| 02-0132-10 |
| 02-0132-11 |
| 02-0132-13 |
| 02-0132-14 |
| 02-0132-15 |
| 02-0132-16 |
| 02-0132-18 |
| 02-0132-20 |

Curved  
Gebogene  
courbé  
Curvo



Standard  
Fig. 3

Curved  
Gebogene  
courbé  
Curvo

|            |
|------------|
| 02-0133-10 |
| 02-0133-11 |
| 02-0133-13 |
| 02-0133-14 |
| 02-0133-15 |
| 02-0133-16 |
| 02-0133-18 |
| 02-0133-20 |



Standard  
14 cm/5½"



Fig. 1  
02-0134-14



Fig. 2  
02-0135-14



Fig. 3  
02-0136-14

# General Instruments

Operating Scissors  
Chirurgische Scheren

Ciseaux d'exploitation  
Tijeras de funcionamiento



Standard  
Fig. 1

|      |        |            |
|------|--------|------------|
| 10.0 | cm/4"  | 02-0137-10 |
| 11.5 | cm/4½" | 02-0137-11 |
| 13.0 | cm/5"  | 02-0137-13 |
| 14   | cm/5½" | 02-0137-14 |
| 15   | cm/6"  | 02-0137-15 |
| 16.0 | cm/6¼" | 02-0137-16 |
| 18.0 | cm/7"  | 02-0137-18 |
| 20.0 | cm/8"  | 02-0137-20 |

Straight  
gerade  
droit  
recto



Standard  
Fig. 2

|            |
|------------|
| 02-0138-10 |
| 02-0138-11 |
| 02-0138-13 |
| 02-0138-14 |
| 02-0138-15 |
| 02-0138-16 |
| 02-0138-18 |
| 02-0138-20 |

Straight  
gerade  
droit  
recto



Standard  
Fig. 3

|            |
|------------|
| 02-0139-10 |
| 02-0139-11 |
| 02-0139-13 |
| 02-0139-14 |
| 02-0139-15 |
| 02-0139-16 |
| 02-0139-18 |
| 02-0139-20 |



Standard  
14cm/5½"



Fig. 1  
02-0140-14



Fig. 2  
02-0141-14

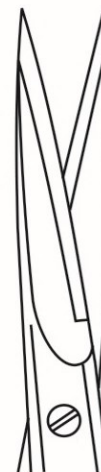

Fig. 3  
02-0142-14

## General Instruments

Dissecting Scissors  
Präparierschere

Ciseaux à dissection  
Tijeras de disección



**Lexer**  
02-0143-16  
16 cm/6¼"  
Striaight  
striaight  
striaight  
striaight



**Lexer**  
02-0144-16  
16 cm/6¼"  
Curved  
Gebogene  
courbé  
Curvo



**Lexer**  
02-0145-16  
16 cm/6¼"  
Striaight  
striaight  
striaight  
striaight



**Lexer**  
02-0146-16  
16 cm/6¼"  
Curved  
Gebogene  
courbé  
Curvo



**Lexer-Fine**  
02-0147-16  
16 cm/6¼"  
Striaight  
striaight  
striaight  
striaight



**Lexer-Fine**  
02-0148-16  
16 cm/6¼"  
Curved  
Gebogene  
courbé  
Curvo



**Lexer-Fine**  
02-0149-16  
16 cm/6¼"  
Striaight  
striaight  
striaight  
striaight



**Lexer-Fine**  
02-0150-16  
16 cm/6¼"  
Curved  
Gebogene  
courbé  
Curvo

# General Instruments

Operating Scissors  
Chirurgische Scheren

Ciseaux d'exploitation  
Tijeras de funcionamiento



**Graziol**



02-0151-13 13.0 cm/5"  
02-0151-14 14 cm/5½"

Curved  
Gebogene  
courbé  
Curvo



02-0152-13  
02-0152-14



**Graziol**



02-0153-13 13.0 cm/5"  
02-0153-14 14 cm/5½"

Striaght  
striaght  
striaght  
striaght



02-0154-13  
02-0154-14



02-0155-15  
Striaght  
striaght  
striaght  
striaght

**Mixer**  
15 cm/6"



02-0156-15  
Curved  
Gebogene  
courbé  
Curvo



02-0157-14  
Striaght  
striaght  
striaght  
striaght

**Deaver**  
14 cm/5½"



02-0158-14  
Curved  
Gebogene  
courbé  
Curvo

## General Instruments

Operating Scissors  
Chirurgische Scheren

Ciseaux d'exploitation  
Tijeras de funcionamiento



**Richter**  
02-0159-14  
14 cm/5 1/2"



**Richter**  
02-0160-14  
14 cm/5 1/2"



02-0161-13 13.0 cm/5 1/4"  
02-0161-14 14 cm/5 1/2"



02-0162-15  
15 cm/6"



**Fergusson**  
02-0163-18  
18 cm/7"



**New Suture**  
02-0164-14  
14 cm/5 1/2"

# General Instruments

Operating and Dissecting Scissors  
Bedienen und Präparierschere

D'exploitation et de dissection Ciseaux  
Operación y Tijeras de disección



**Mayo**

02-0165-14 14 cm/5 1/2"  
02-0165-15 15.0 cm/6"  
02-0165-17 17.0 cm/6 3/4"  
02-0165-19 20.0 cm/8"  
02-0165-23 23.0 cm/9"

Striaight  
striaight  
striaight  
striaight



**Mayo**

02-0166-14 14 cm/5 1/2"  
02-0166-15 15.0 cm/6"  
02-0166-17 17.0 cm/6 3/4"  
02-0166-19 20 cm/8"  
02-0166-23 23.0 cm/9"

Curved  
Gebogene  
courbé  
Curvo



**Mayo**

02-0167-14 14 cm/5 1/2"  
02-0167-17 17.0 cm/6 3/4"  
02-0167-23 23.0 cm/9"

Striaight  
striaight  
striaight  
striaight



**Mayo**

02-0168-14 14 cm/5 1/2"  
02-0168-17 17.0 cm/6 3/4"  
06-4168-23 23.0 cm/9"

Curved  
Gebogene  
courbé  
Curvo



**Mayo-Still**

02-0169-15 15 cm/6"  
02-0169-17 17 cm/6 3/4"  
02-0169-19 20 cm/8"  
02-0169-21 23cm/9"

Striaight  
striaight  
striaight  
striaight



**Mayo-Still**

02-0170-15 15 cm/6"  
02-0170-17 17 cm/6 3/4"  
02-0170-19 20 cm/8"  
02-0170-21 23 cm/9"

Curved  
Gebogene  
courbé  
Curvo



**Mayo-Still**

02-0171-15 15 cm/6"  
02-0171-17 17 cm/6 3/4"

Striaight  
striaight  
striaight  
striaight



**Mayo-Still**

02-0172-15 15 cm/6"  
02-0172-17 17 cm/6 3/4"

Curved  
Gebogene  
courbé  
Curvo

## General Instruments

Operating and Dissecting Scissors  
Bedienen und Präparierschere

D'exploitation et de dissection Ciseaux  
Operación y Tijeras de disección



**Baby-Metzenbaum**  
02-0173-11  
11.5 cm/4½"



**Baby-Metzenbaum**  
02-0174-11  
11.5 cm/4½"



**Mayo-Noble**  
02-0175-17  
17 cm/6¾"



**Mayo-Noble**  
02-0176-17  
17 cm/6¾"

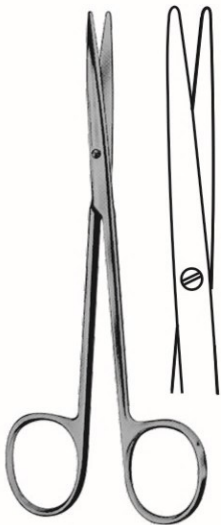

**Metzenbaum-Fine**  
02-0177-14  
14 cm/5½"

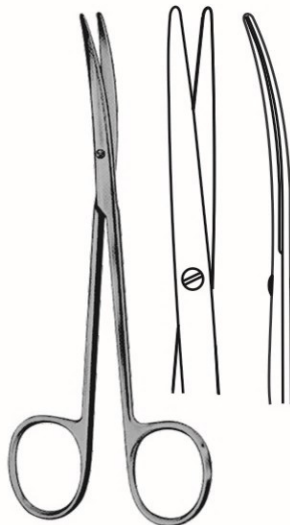

**Metzenbaum-Fine**  
02-0178-14  
14 cm/5½"

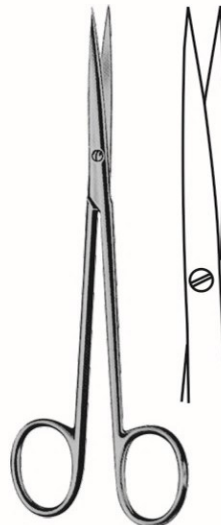

**Metzenbaum-Fine**  
02-0179-14  
14 cm/5½"



**Metzenbaum-Fine**  
02-0180-14  
14 cm/5½"

# General Instruments

Dissecting Scissors  
Präparierschere

Ciseaux à dissection  
Tijeras de disección



Fig 1

**Metzenbaum**  
02-0181-14  
14 cm/5 1/2"



Fig 2

**Metzenbaum**  
02-0182-14  
14 cm/5 1/2"



Fig 3

**Metzenbaum**  
02-0183-14  
14 cm/5 1/2"

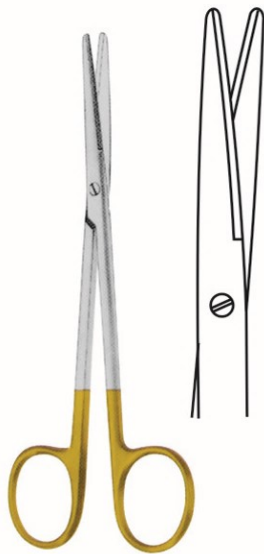

**Metzenbaum**  
02-0184-14  
14 cm/5 1/2"



**Metzenbaum-Fine**  
02-0185-14  
14 cm/5 1/2"



**Metzenbaum-Fine**  
02-0186-14  
14 cm/5 1/2"



Fig. 1  
**Metzenbaum**  
02-0187-14  
14 cm/5 1/2"



Fig. 2  
**Metzenbaum**  
02-0188-14  
14 cm/5 1/2"



Fig. 3  
**Metzenbaum**  
02-0189-14  
14 cm/5 1/2"

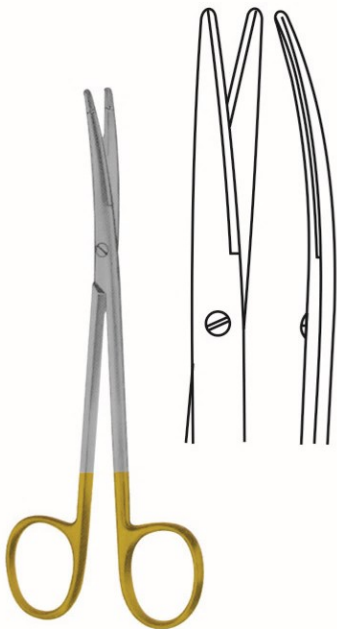

**Metzenbaum**  
02-0190-14  
14 cm/5 1/2"



**Metzenbaum-Fine**  
02-0191-14  
14 cm/5 1/2"

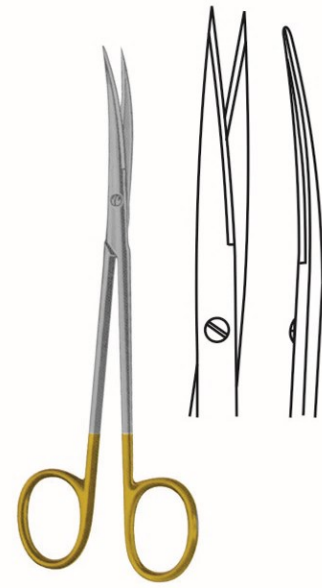

**Metzenbaum-Fine**  
02-0192-14  
14 cm/5 1/2"

# General Instruments

Dissecting Scissors  
Präparierschere

Ciseaux à dissection  
Tijeras de disección



**Metzenbaum-Fine**

|           |            |
|-----------|------------|
| 18 cm/7"  | 02-0193-18 |
| 20 cm/8"  | 02-0193-20 |
| 23 cm/9"  | 02-0193-23 |
| 25 cm/10" | 02-0193-25 |
| 28 cm/11" |            |
| 30 cm/12" |            |



**Metzenbaum**

|            |
|------------|
| 02-0194-18 |
| 02-0194-20 |
| 02-0194-23 |
| 02-0194-25 |
| 02-0194-28 |
| 02-0194-30 |



**Metzenbaum**

|            |
|------------|
| 02-0195-18 |
| 02-0195-20 |
| 02-0195-23 |
| 02-0195-25 |
| 02-0195-28 |
| 02-0195-30 |



**Metzenbaum**

|            |
|------------|
| 02-0196-18 |
| 02-0196-20 |
| 02-0196-23 |
| 02-0196-25 |
| 02-0196-28 |
| 02-0196-30 |



**Metzenbaum**

|           |            |
|-----------|------------|
| 18 cm/7"  | 02-0197-18 |
| 20 cm/8"  | 02-0197-20 |
| 23 cm/9"  | 02-0197-23 |
| 25 cm/10" | 02-0197-25 |
| 28 cm/11" | 02-0197-28 |
| 30 cm/12" | 02-0197-30 |



**Metzenbaum-Fine**

|            |
|------------|
| 02-0198-18 |
| 02-0198-20 |
| 02-0198-23 |
| 02-0198-25 |



**Metzenbaum-Fine**

|            |
|------------|
| 02-0199-18 |
| 02-0199-20 |
| 02-0199-23 |
| 02-0199-25 |

## General Instruments

Dissecting Scissors  
Präparierschere

Ciseaux à dissection  
Tijeras de disección



**Metzenbaum-Fine**

18 cm/7" 02-0200-18  
20 cm/8" 02-0200-20  
23 cm/9" 02-0200-23  
25 cm/10" 02-0200-25  
28 cm/11" 02-0200-28  
30 cm/12" 02-0200-30



**Metzenbaum**

02-0201-18  
02-0201-20  
02-0201-23  
02-0201-25  
02-0201-28  
02-0201-30



**Metzenbaum**

02-0202-18  
02-0202-20  
02-0202-23  
02-0202-25  
02-0202-28  
02-0202-30



**Metzenbaum**

02-0203-18  
02-0203-20  
02-0203-23  
02-0203-25  
02-0203-28  
02-0203-30



**Metzenbaum**

18 cm/7" 02-0204-18  
20 cm/8" 02-0204-20  
23 cm/9" 02-0204-23  
25 cm/10" 02-0204-25  
28 cm/11" 02-0204-28  
30 cm/12" 02-0204-30



**Metzenbaum-Fino**

02-0205-18  
02-0205-20  
02-0205-23  
02-0205-25  
02-0205-28



**Metzenbaum-Fino**

02-0206-18  
02-0206-20  
02-0206-23

# General Instruments

Gynecological Scissors  
gynäkologische Scheren

Ciseaux gynécologiques  
Tijeras ginecológicas



**Sims**  
02-0207-20 20 cm/8"  
02-0207-23 23 cm/9"

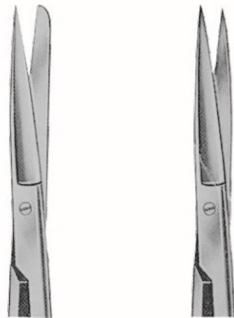

02-0208-20 20 cm/8" 02-0209-20  
02-0208-23 23 cm/9" 02-0209-23  
Striight  
striight  
striight  
striight



**Sims**  
02-0210-20 20 cm/8"  
02-0210-23 23 cm/9"



02-0211-20 20 cm/8" 02-0212-20  
02-0211-23 23 cm/9" 02-0212-23  
Curved  
Gebogene  
courbé  
Curvo

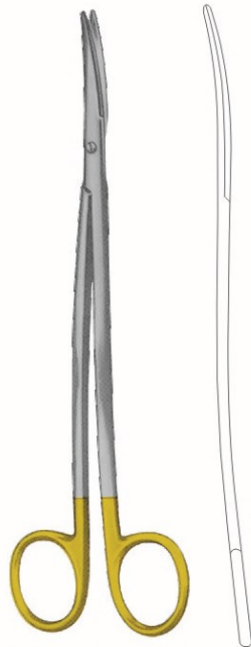

**Metzenbaum-Fino**  
02-0213-20 20 cm/8"  
02-0213-23 23 cm/7"

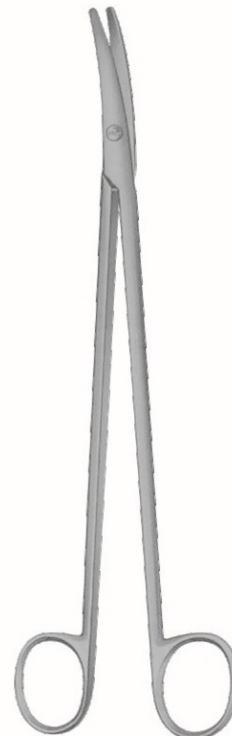

**Weller**  
02-0214-14 14 cm/5 1/2"  
02-0214-19 19.5 cm/7 3/4"  
02-0214-22 22.5 cm/9"

## General Instruments

Gynecological Scissors  
gynäkologische Scheren

Ciseaux gynécologiques  
Tijeras ginecológicas



**Dubois**  
02-0215-27 27cm/10 ½"

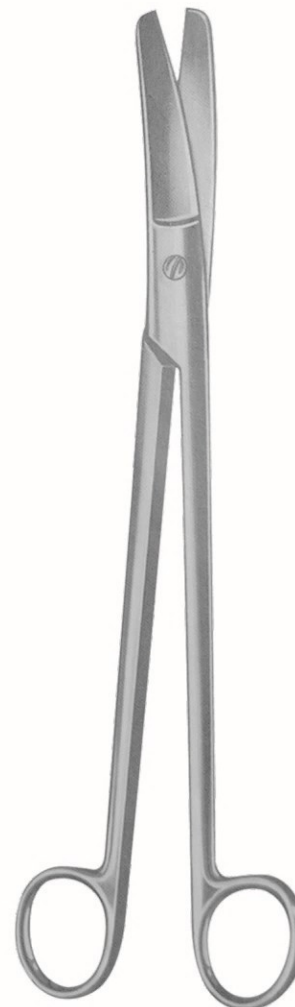

**Dubois**  
02-0216-27 27cm/10 ½"



**Sims**  
02-0217-20 20 cm/8"  
02-0217-23 23 cm/9"



**Wertheim**  
02-0218-14 14 cm/5 ½"  
02-0218-19 19.5cm/7 ¾"  
02-0218-22 22.5cm/9"

# General Instruments

Gynecological Scissors  
gynäkologische Scheren

Ciseaux gynécologiques  
Tijeras ginecológicas



**Kelly**  
16 cm/6 1/4" 02-0219-16  
18 cm/7" 02-0219-18



**Kelly**  
02-0220-16  
02-0220-18



**Siebold**  
02-0221-24 24 cm/9 1/2"



**Deyen**  
16 cm/6 1/4" 02-0222-16  
18 cm/7" 02-0222-18



**Deyen**  
02-0223-16  
02-0223-18

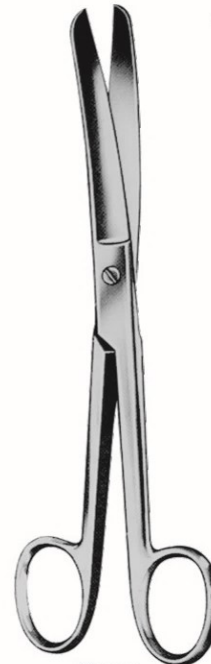

**Deyen**  
02-0224-16  
02-0224-18



**Fig. 01**  
02-0225-12



**Fig. 2**  
02-0226-12  
S/B



Striaght  
striaght  
striaght  
striaght  
12 cm/4<sup>3/4</sup>"

**Fig. 3**  
02-0227-12  
S/S



**Fig. 1**  
02-0228-12



**Fig. 2**  
02-0229-12  
S/B



Curved  
Gebogene  
courbé  
Curvo  
12 cm/4<sup>3/4</sup>"

**Fig. 3**  
02-0230-12  
S/S



**Wagner**  
02-0231-12  
12 cm/4<sup>3/4</sup>"



Striaght  
striaght  
striaght  
striaght

**Fig. 1**  
02-0232-01



**Fig. 2**  
02-0233-02



**Fig. 3**  
02-0234-03



Saw edge  
Saw Rand  
Scie à bord  
Saw borde

**Fig. 4**  
02-0238-04



Curved  
Gebogene  
courbé  
Curvo

**Fig. 1**  
02-0235-01



**Fig. 2**  
02-0236-02



**Fig. 3**  
02-0237-03

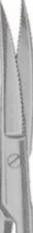

**Fig. 4**  
02-0239-04



02-0240-11  
11.5 cm/4<sup>1/2</sup>"



02-0241-11  
11.5 cm/4<sup>1/2</sup>"

Striaght  
striaght  
striaght  
striaght

Curved  
Gebogene  
courbé  
Curvo

# General Instruments

Fine Scissors  
feinen Schere

Ciseaux Beaux-  
tijeras finas



**Brophy (Sullivan)**  
02-0242-14  
14 cm/5½"  
Striight  
striight  
striight  
striight



02-0243-14  
14 cm/5½"  
Curved  
Gebogene  
courbé  
Curvo



**Reynolds**  
02-0244-15  
02-0244-18  
Striight  
striight  
striight  
striight

15 cm/6"  
18 cm/7"



02-0245-15  
02-0245-18  
Curved  
Gebogene  
courbé  
Curvo

## Enucleation Scissors



**Jameson**  
02-0246-15  
15 cm/6"



02-0247-12



02-0248-12



**Landolt**  
12.5 cm /5"



02-0249-12



02-0250-12



02-0251-09  
9cm/3 1/2"



02-0252-10  
10cm/4"

extra flat  
extra flach  
extra plat  
extra plano



**Walton**  
02-0253-10  
10cm/4"



9.0 cm/3 1/2" 02-0254-09  
10.5 cm/4 1/4" 02-0254-10  
11.5 cm/4 1/2" 02-0254-11

02-0255-09  
02-0255-10  
02-0255-11

02-0256-09  
02-0256-10  
02-0256-11

02-0257-09  
02-0257-10  
02-0257-11

**Standard**

02-0258-09  
02-0258-10  
02-0258-11

# General Instruments

Fine Scissors  
feinen Schere

Ciseaux Beaux-  
tijeras finas

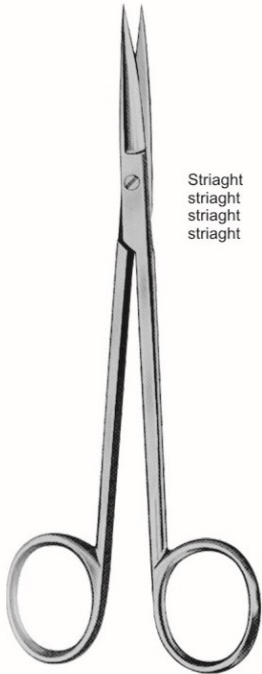

Striight  
striight  
striight  
striight

02-0259-14

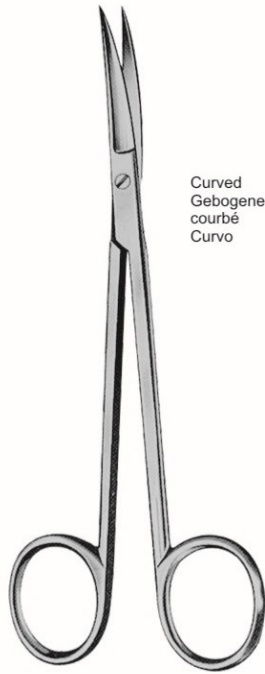

Curved  
Gebogene  
courbé  
Curvo

**Sanvenero**  
14 cm/5 1/2"

02-0260-14



Striight  
striight  
striight  
striight

02-0261-10

**Baby-Lexer (Knapp)**  
10cm/4"



Curved  
Gebogene  
courbé  
Curvo

02-0262-10

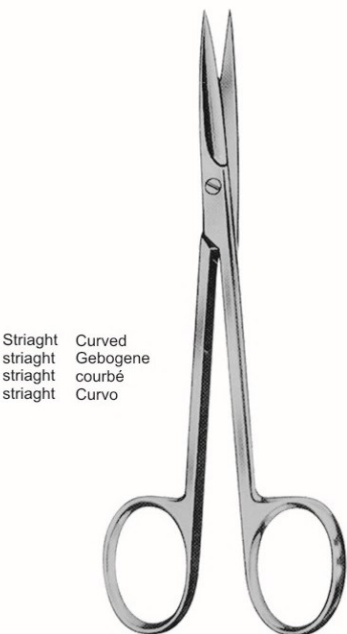

Striight  
striight  
striight  
striight

02-0263-13

13cm/5"

02-0264-13



Striight  
striight  
striight  
striight

02-0265-14



Curved  
Gebogene  
courbé  
Curvo

**Joseph**  
14cm/5 1/2"

02-0266-14



**Kilner (Ragnell)**  
02-0267-12 12cm/4¾"  
02-0267-13 13cm/5"  
02-0267-15 15cm/6"



02-0268-14  
14 cm/5½"

Coronary Scissors  
Ciseaux coronaires  
Tijeras coronarias

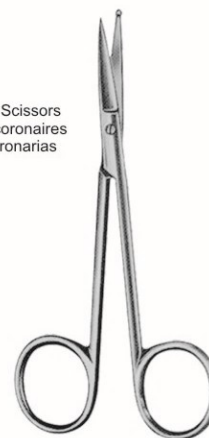

02-0269-11  
11.5cm/4½"



**Potts-Smith**  
02-0270-19  
20 cm/8"



**De Bakey**  
02-0271-15  
15.5cm/6"



**De Bakey**  
02-0272-15  
15.5cm/6"



**Favaloro**  
02-0273-15  
15cm/6"

# General Instruments

Vascular Scissors  
Vaskuläre Schere

Ciseaux vasculaires  
Tijeras vasculares

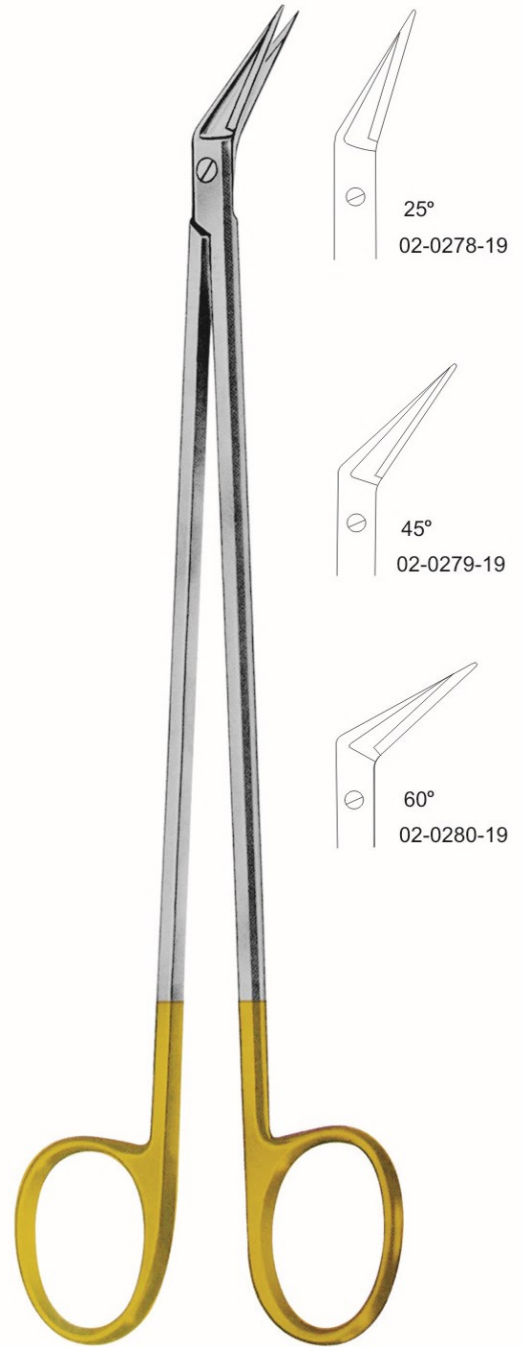
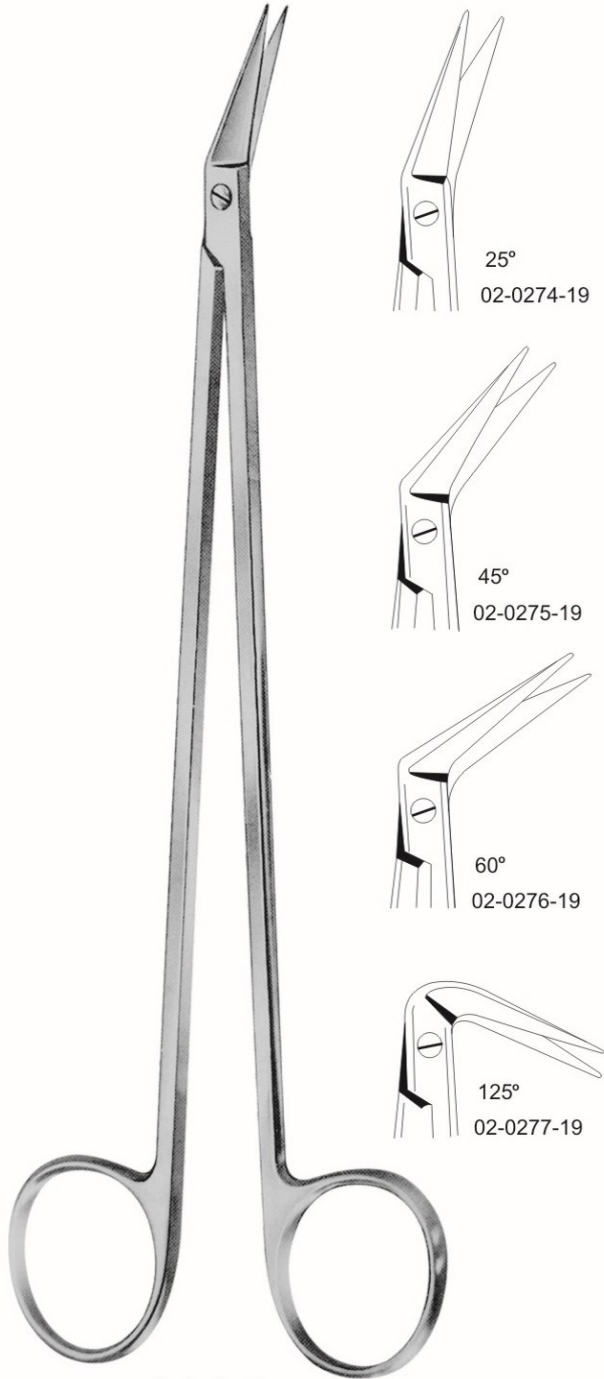

## General Instruments

**Cartilage and Vascular Scissors**  
Knorpel-und Gefäß-Schere

Le cartilage et Ciseaux vasculaires  
El cartilago y Tijeras vasculares



Saw edge  
Saw Rand  
Scie à bord  
Saw borde

**Martin-Cartilage**  
02-0281-20  
20cm/8"



**McIndoe**  
02-0282-19  
19cm/7½"



**Potts-Smith**  
02-0283-19  
19cm/7½"



**Satinsky**  
02-0284-24  
24.5cm/10"



**Klingenberg-Loth**  
02-0285-23  
23cm/9"

# General Instruments

Vascular Scissors  
Vaskuläre Schere

Ciseaux vasculaires  
Tijeras vasculares



**De Bakey**  
18cm/7"

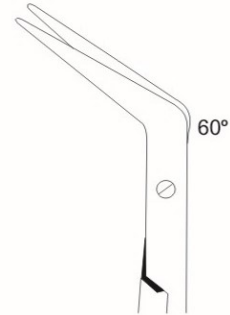
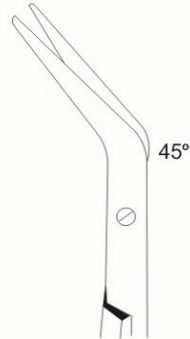
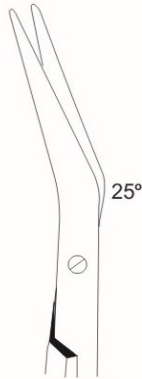

| cm     | In  |            |            |            |
|--------|-----|------------|------------|------------|
| 16.0cm | 6¼" | 02-0286-16 | 02-0287-16 | 02-0288-16 |
| 23.0cm | 9"  | 02-0286-23 | 02-0287-23 | 02-0288-23 |
| 28.0cm | 11" | 02-0286-28 | 02-0287-28 | 02-0288-28 |

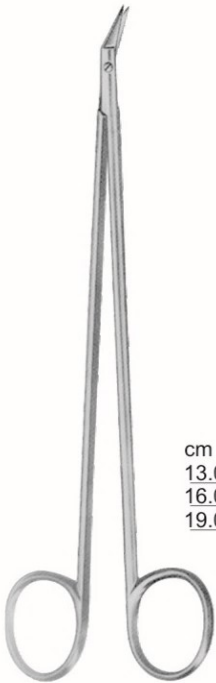

**Baby-Hegemann**  
14 cm/5 ½"

**Hegemann (Diethrich)**  
16cm/6¼"  
19cm/7½"

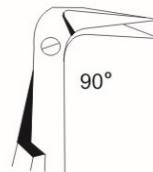
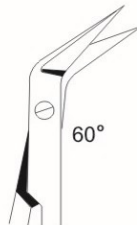

| cm     | In  |            |            |            |            |            |
|--------|-----|------------|------------|------------|------------|------------|
| 13.0cm | 5¼" | 02-0289-13 | 02-0290-13 | 02-0291-13 | 02-0292-13 | 02-0293-13 |
| 16.0cm | 6¼" | 02-0289-16 | 02-0290-16 | 02-0291-16 | 02-0292-16 | 02-0293-16 |
| 19.0cm | 7½" | 02-0289-19 | 02-0290-19 | 02-0291-19 | 02-0292-19 | 02-0293-19 |

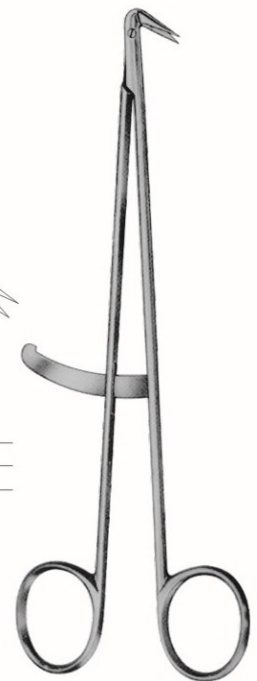

**Hegemann (Diethrich)**  
02-0294-19  
19cm/7½"

## General Instruments

Vascular Scissors  
Vaskuläre Schere

Ciseaux vasculaires  
Tijeras vasculares



18cm/7"

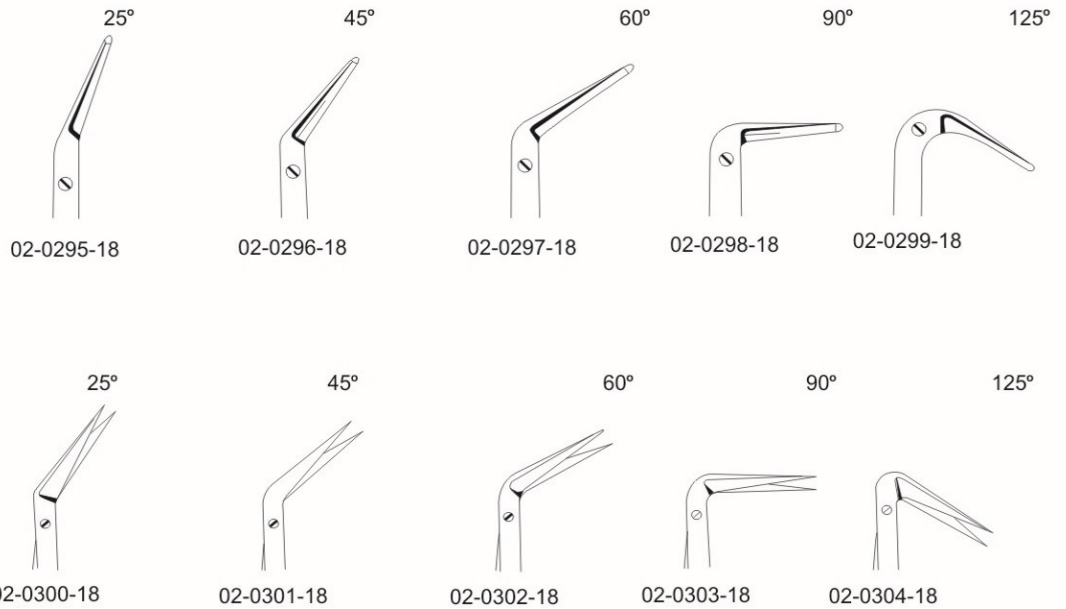

# General Instruments

Dissecting and Tonsil Scissors  
Anatomische und Tonsil Schere

Dissection et Ciseaux amygdales  
Tijeras de disección y amígdalas



02-0305-15  
15cm/6"



**Bottcher**  
02-0306-18  
18cm/7"



**Prince**  
02-0307-17  
17.5cm/7"



**Adson-Fine**  
02-0308-17  
17.5cm/7"



**Tonnis**  
02-0309-18  
18cm/7"



**Tonnis**  
02-0310-18  
18cm/7"



**Adson**  
02-0311-17  
17.5cm/7"



**Adson**  
02-0312-17  
17.5cm/7"

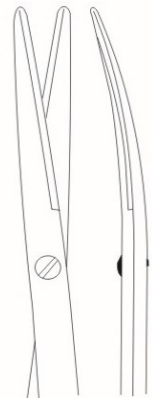

## General Instruments

Tonsil and Enterotomy Scissors  
Tonsil und Enterotomie Schere

Ciseaux amygdales et entérotomie  
Las amígdalas y Enterotomía Tijeras



**Good**  
02-0313-19  
19 cm/7½"



**Crafoord**  
02-0314-30  
30 cm/12"



**Finochietto**  
02-0315-27  
27 cm/10½"



02-0316-21  
21 cm/8¼"

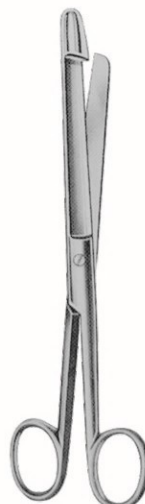

02-0317-21  
21 cm/8¼"



02-0318-21  
21 cm/8¼"

# General Instruments

Umbilicat and Episiotomy Scissors  
Umbilicat und Dammscheren

Umbilicat et Ciseaux épisiotomie  
Umbilicat y Tijeras Episiotomía

**Accu-Med**<sup>®</sup>  
Instrument Co.



**Busch**  
02-0319-13 13 cm/5"  
02-0319-16 16 cm/6¼"



**Schumacher**  
02-0320-16  
16 cm/6¼"



**Mod. USA**  
02-0321-10  
10.5cm/4¼"  
02-0321-12  
12.5cm



**Braun-Stadler**  
02-0322-14  
14 cm/5½"



**Braun-Stadler**  
02-0323-22  
22 cm/8½"



**Waldmann**  
02-0324-18  
18 cm/7"

## General Instruments

Perineum Episiotomy Scissors  
Perineum Dammscheren

Ciseaux épisiotomie périnée  
Tijeras perineo episiotomía



Parametrium Scissors  
Ciseaux parametrium  
parametrium Tijeras



02-0325-01  
23 cm/9"



02-0325-02  
23 cm/9"



02-0326-19  
19 cm/7 1/2"



02-0327-19  
19 cm/7 1/2"

# General Instruments

Nasal Scissors  
Nasenschere

Ciseaux nasale  
nasal Tijeras



**Heymann**  
02-0328-18  
18 cm/7"



**Heymann**  
02-0329-19  
20 cm/8 "



**Knight**  
02-0330-18  
18 cm/7"



**Fomon**  
02-0331-13  
13 cm/5"



**Fomon**  
02-0332-13  
13.5 cm/5 1/4"



**Fomon**  
02-0333-13  
13.5 cm/5 1/4"



**Cottle**  
02-0334-16  
16 cm/6 1/4"



**Halle**  
02-0335-19  
19 cm/7 1/4"

# General Instruments

Dissecting Trigeminal, Wire Cutting and Gum Scissors  
Dissecting Trigeminus, Drahterodieren und Gum Schere

Dissection du trijumeau découpe au fil, et Ciseaux Gum  
La disección de corte del trigémino, alambre y tijeras de goma



**Universal**  
02-0336-12  
12 cm/4¾"



**Goldman-Fox**  
02-0337-13  
13 cm/5"  
Striaght  
striaght  
striaght  
striaght



**Goldman-Fox**  
02-0338-13  
13 cm/5"  
Curved  
Gebogene  
courbé  
Curvo

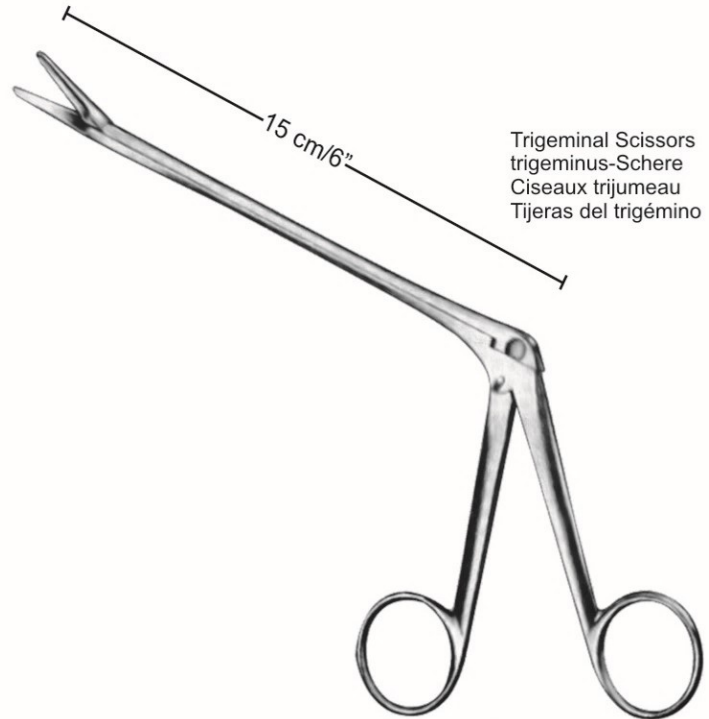

Trigeminal Scissors  
trigeminus-Schere  
Ciseaux trijumeau  
Tijeras del trigémino



**Dandy**  
02-0339-17  
17 cm/6¾"

**Olivecrona**  
02-0340-15

# General Instruments

Iridectomy Scissors  
Iridektomie Schere

Ciseaux iridectomie  
Tijeras iridectomía



**Barraquer**  
02-0341-05  
5.5 cm/2¼"



**Noyes**  
02-0342-01  
02-0342-02  
02-0342-03  
12 cm/4¾"

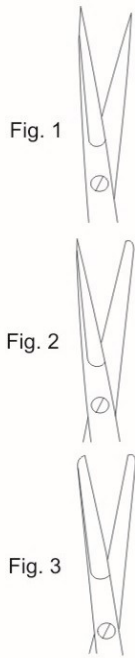
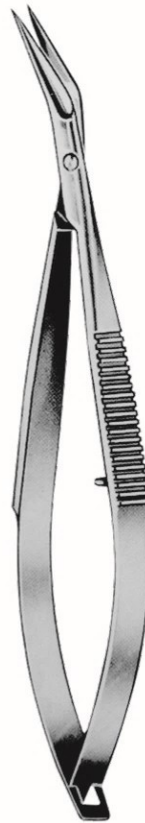

Fig. 1

Fig. 2

Fig. 3



**Noyes**  
02-0343-12  
12 cm/4¾"



**Wecker**  
02-0344-01  
11.5 cm/4½"



02-0344-02



02-0344-03

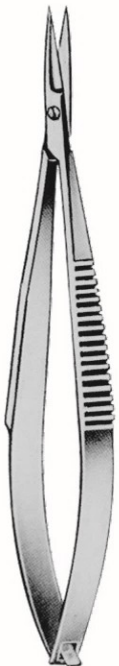

02-0345-09  
9 cm/3½"



02-0346-09



02-0347-09



02-0348-09



02-0349-09



02-0350-09

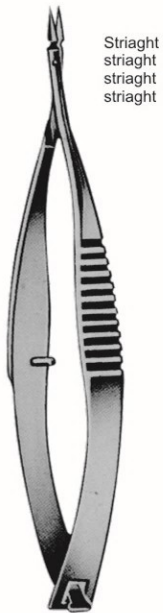

Striaight  
striaight  
striaight  
striaight

**Vannas**  
02-0351-08  
8 cm/3¼"

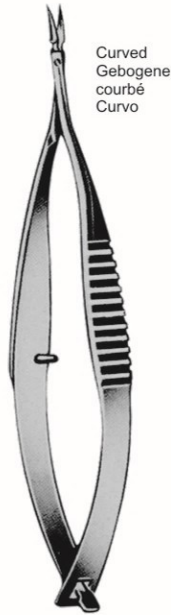

Curved  
Gebogene  
courbé  
Curvo

**Vannas**  
02-0352-08  
8 cm/3¼"

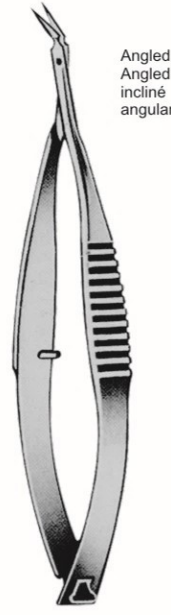

Angled  
Angled  
incliné  
angular

**Vannas**  
02-0353-08  
8 cm/3¼"

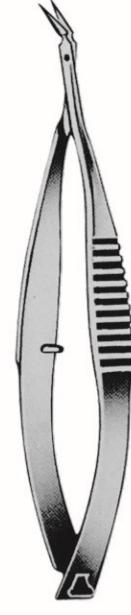

**Vannas**  
02-0354-08  
8 cm/3¼"

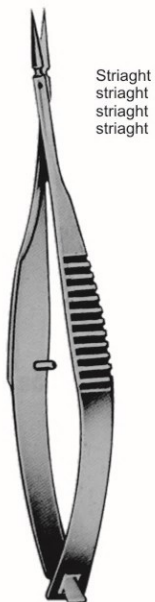

Striaight  
striaight  
striaight  
striaight

02-0355-08  
8.5 cm/3¼"

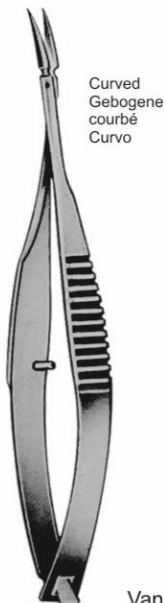

Curved  
Gebogene  
courbé  
Curvo

02-0356-08  
8.5 cm/3½"

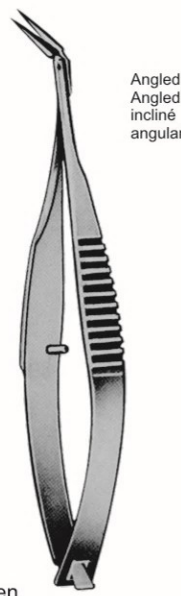

Angled  
Angled  
incliné  
angular

02-0357-08  
8.5 cm/3½"

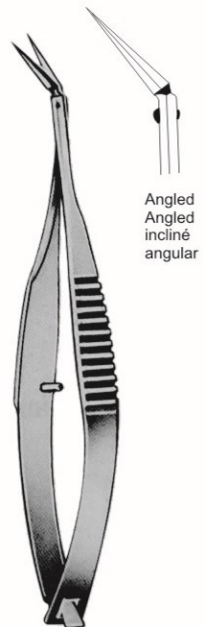

Angled  
Angled  
incliné  
angular

02-0358-08  
8.5 cm/3½"

# General Instruments

Iridectomy Scissors  
Iridektomie Schere

Ciseaux iridectomie  
Tijeras iridectomía

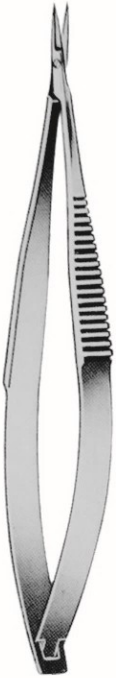

02-0359-10  
10 cm/4"

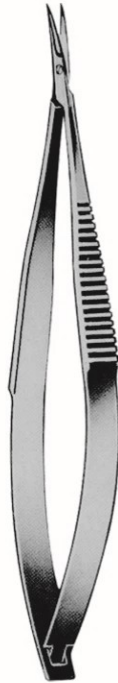

02-0360-10  
10 cm/4"

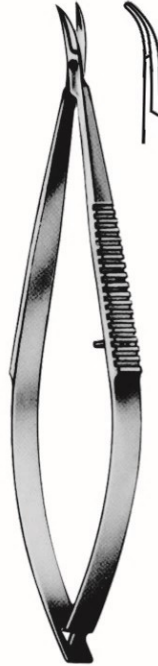

**Castroviejo**  
02-0361-10  
10 cm/4"



**Castroviejo**  
02-0362-10  
10 cm/4"



**Aebil**  
02-0363-10  
10 cm/4"

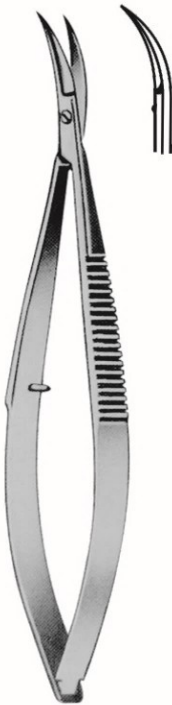

**Castroviejo**  
02-0364-10  
10 cm/4"



**Castroviejo**  
02-0365-10  
10 cm/4"

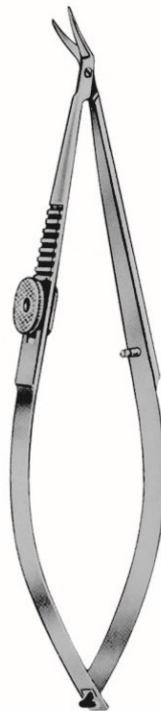

**Troutman-Barraquer**  
02-0366-10  
10 cm/4"



**Troutman-Barraquer**  
02-0367-10  
10 cm/4"



**Troutman**  
02-0368-10  
10 cm/4"



**Troutman**  
02-0369-10  
10 cm/4"



**Katzin-Barraquer**  
02-0370-10  
10 cm/4"



**Katzin-Barraquer**  
02-0371-10  
10 cm/4"



**Katzin**  
02-0372-10  
10 cm/4"



**Katzin**  
02-0373-10  
10 cm/4"



**Westcott**  
02-0374-11  
11.5 cm/4½"



**Westcott**  
02-0375-11  
11.5 cm/4½"



**Westcott**  
02-0376-11  
11.5 cm/4½"

# General Instruments

Iridectomy Scissors  
Iridektomie Schere

Ciseaux iridectomie  
Tijeras iridectomia



**Castroviejo**  
02-0377-10  
10 cm/4"

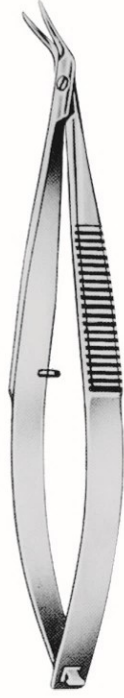

**Castroviejo**  
02-0378-10  
10 cm/4"

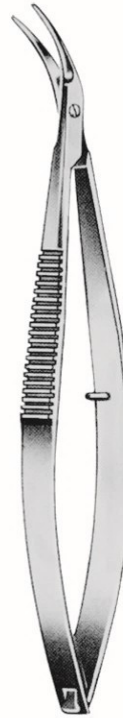

**Castroviejo**  
02-0379-11  
11.5 cm/4½"

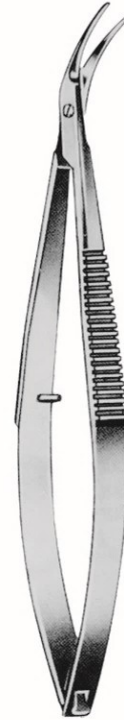

**Castroviejo**  
02-0380-11  
11.5 cm/4½"



**Troutmann-Castroviejo**  
02-0381-10  
10.5 cm/4¼"



**Troutmann-Castroviejo**  
02-0382-10  
10.5 cm/4¼"



**Straight**  
02-0383-14  
02-0383-18

**Curved**  
02-0384-14  
02-0384-18

14.5 cm/5¾"  
18.0 cm/7"

# General Instruments

Micro Scissors  
Micro Scissors

Ciseaux Micro  
Micro Tijeras



Striaight  
striaight  
striaight

02-0385-12 12.0 cm/4 3/4"  
02-0385-16 16.0 cm/6 1/4"  
02-0385-18 18.5 cm/7 1/4"



Curved  
Gebogene  
courbé  
Curvo

02-0386-12 12.0 cm/4 3/4"  
02-0386-16 16.0 cm/6 1/4"  
02-0386-18 18.5 cm/7 1/4"



Striaight  
striaight  
striaight

22.5cm/9" 02-0389-22  
24.5cm/9 3/4" 02-0389-24



Curved  
Gebogene  
courbé  
Curvo

02-0390-22  
02-0390-24



Striaight  
striaight  
striaight

16.5cm/6 1/2"  
20.0cm/8" 02-0387-16  
02-0387-20



Curved  
Gebogene  
courbé  
Curvo

02-0388-16  
02-0388-20

# General Instruments

Micro Scissors  
Micro Scissors

Ciseaux Micro  
Micro Tijeras

02-0391-18



02-0392-19

02-0393-18



02-0394-19

02-0395-18



02-0396-19

02-0397-19



02-0398-19

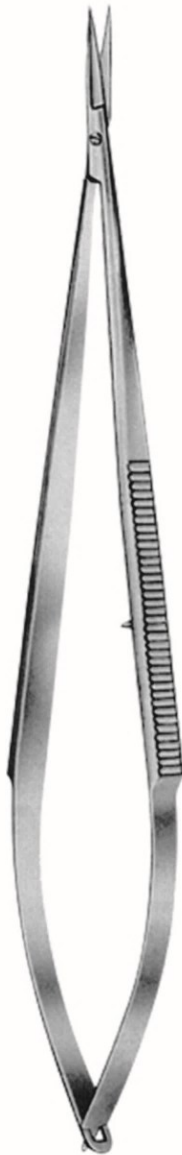

**Jacobson**  
18cm/7"



19cm/7½"

Vein Scissors  
Ciseaux veine  
Tijeras Vena



02-0399-12  
12cm/4<sup>3</sup>/<sub>4</sub>"

Striaight  
striaight  
striaight  
striaight



02-0400-12  
12cm/4<sup>3</sup>/<sub>4</sub>"

Curved  
Gebogene  
courbé  
Curvo



02-0401-12  
12cm/4<sup>3</sup>/<sub>4</sub>"

Striaight  
striaight  
striaight  
striaight



02-0402-03  
12cm/4<sup>3</sup>/<sub>4</sub>"

Curved  
Gebogene  
courbé  
Curvo



02-0403-12  
12cm/4<sup>3</sup>/<sub>4</sub>"

Angled up  
abgewinkelt up  
angle vers le haut  
un ángulo de

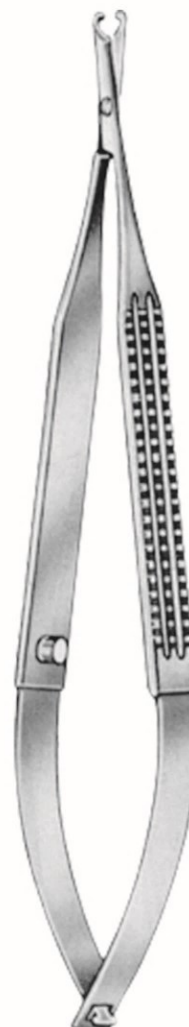

Straight  
02-0404-13  
13cm/5"

Striaight  
striaight  
striaight  
striaight

# General Instruments

Micro Scissors  
Micro Scissors

Ciseaux Micro  
Micro Tijeras

**Accu-Med**<sup>®</sup>  
Instrument Co.

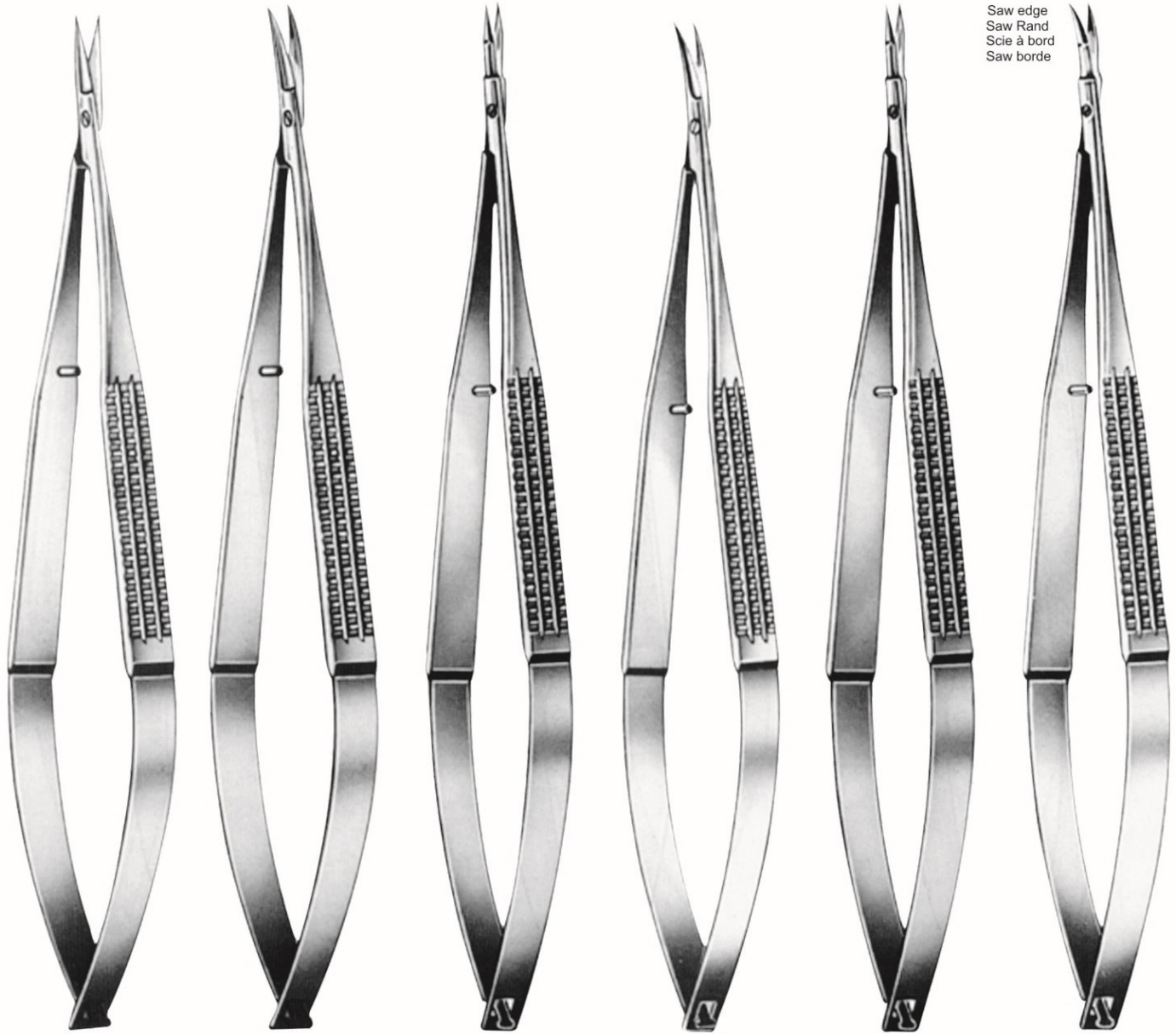

Saw edge  
Saw Rand  
Scie à bord  
Saw borde

02-0405-16  
16cm/6¼"  
Striaight  
striaight  
striaight  
striaight

02-0406-16  
16cm/6¼"  
Curved  
Gebogene  
courbé  
Curvo

02-0407-16  
16cm/6¼"  
Striaight  
striaight  
striaight  
striaight

02-0408-16  
16cm/6¼"  
Curved  
Gebogene  
courbé  
Curvo

**Millesi**  
02-0409-16  
16cm/6¼"  
Striaight  
striaight  
striaight  
striaight

**Millesi**  
02-0410-16  
16cm/6¼"  
Curved  
Gebogene  
courbé  
Curvo

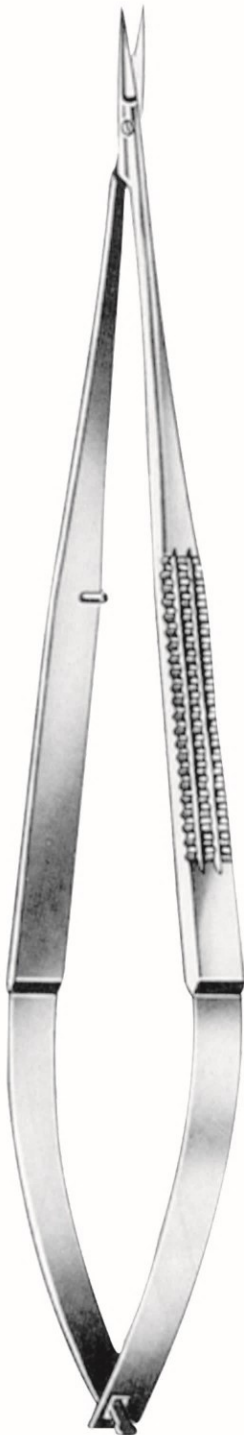

02-0411-18  
18.5cm/7¼"  
Striight  
striight  
striight  
striight

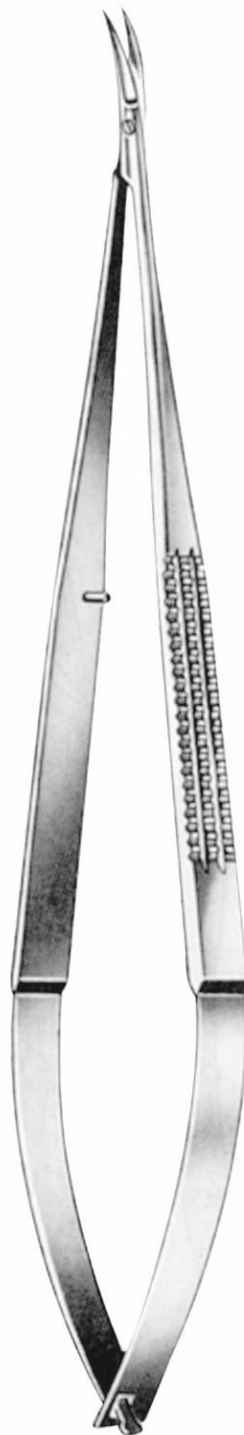

02-0412-18  
18.5cm/7¼"  
Curved  
Gebogene  
courbé  
Curvo

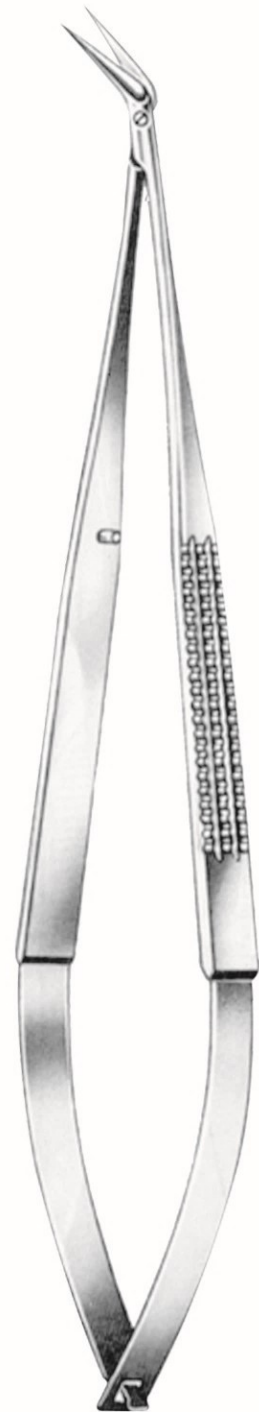

02-0413-18  
18.5cm/7¼"  
Angled  
Angled  
incliné  
angular

# General Instruments

Micro Scissors  
Micro Scissors

Ciseaux Micro  
Micro Tijeras

Accu-Med<sup>®</sup>  
Instrument Co.

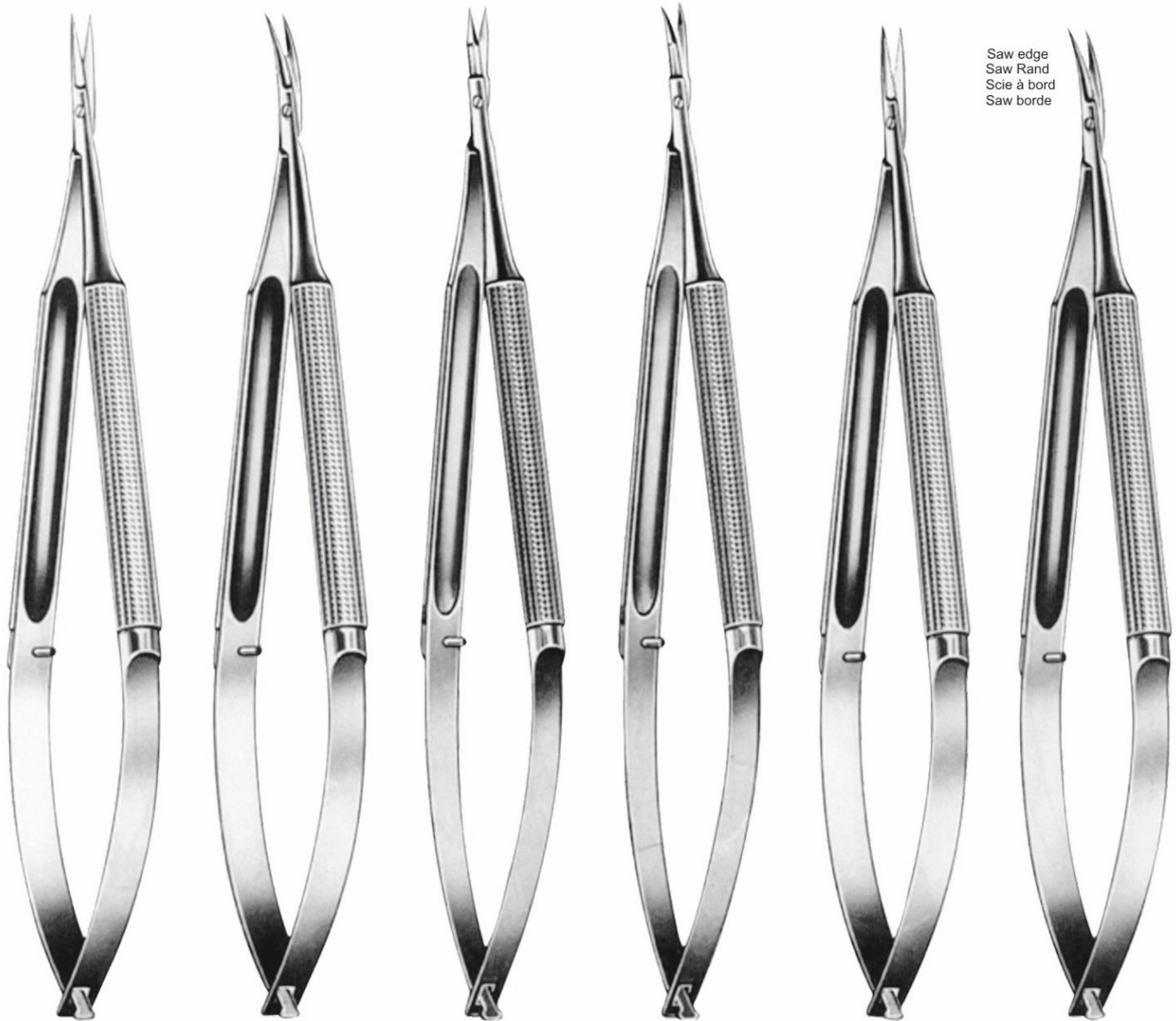

Saw edge  
Saw Rand  
Scie à bord  
Saw borde

02-0414-16  
16cm/6 1/4"  
Striaght  
striaght  
striaght  
striaght

02-0415-16  
16cm/6 1/4"  
Curved  
Gebogene  
courbé  
Curvo

02-0416-16  
16cm/6 1/4"  
Striaght  
striaght  
striaght  
striaght

02-0417-16  
16cm/6 1/4"  
Curved  
Gebogene  
courbé  
Curvo

02-0418-16  
16cm/6 1/4"  
Striaght  
striaght  
striaght  
striaght

02-0419-16  
16cm/6 1/4"  
Curved  
Gebogene  
courbé  
Curvo



02-0420-18  
18.5cm/7¼"  
Striaght  
striaght  
striaght  
striaght



02-0421-18  
18.5cm/7¼"  
Curved  
Gebogene  
courbé  
Curvo



02-0422-18  
18.5cm/7¼"  
Angular  
Angled  
incliné

# General Instruments

Micro Scissors  
Micro Scissors

Ciseaux Micro  
Micro Tijeras

Accu-Med<sup>®</sup>  
Instrument Co.

Dissecting Scissors  
Präparier schere  
Ciseaux à dissection  
Tijeras de disección



02-0423-14  
14 cm/5 1/2"  
Striight  
striight  
striight  
striight

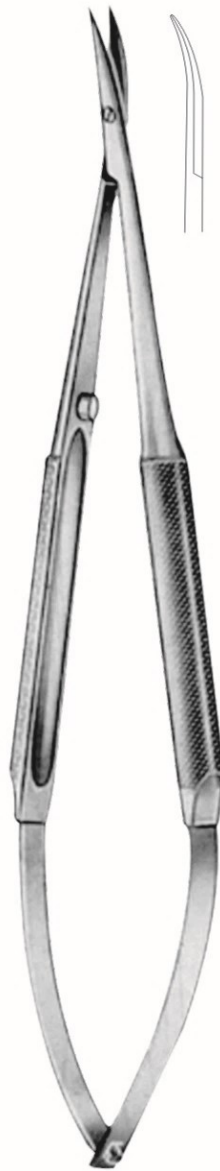

02-0424-14  
14 cm/5 1/2"  
Curved  
Gebogene  
courbé  
Curvo



02-0425-14  
14 cm/5 1/2"  
Curved  
Gebogene  
courbé  
Curvo

# General Instruments

Eye and Fine Scissors

Augen-und einer feinen Schere

Des yeux et des ciseaux fins

Los ojos y tijeras finas



02-0426-12  
Striaght  
striaght  
striaght  
striaght

12cm/4¾"



02-0427-12  
Curved  
Gebogene  
courbé  
Curvo



11.5cm/4½"



02-0428-11



02-0430-11



02-0429-11



02-0431-11



**Knapp**  
10.5cm/4¼"



02-0432-10



02-0434-10



02-0436-10



02-0433-10



02-0435-10



02-0437-10



02-0438-11  
Striaght  
striaght  
striaght  
striaght

11.5cm/4½"



02-0439-11  
Curved  
Gebogene  
courbé  
Curvo

# General Instruments

Eye Scissors  
Augenschere

Ciseaux Eye  
Tijeras del ojo



Striaight  
striaight  
striaight  
striaight



Curved  
Gebogene  
courbé  
Curvo



## Standard

|             |            |            |            |            |
|-------------|------------|------------|------------|------------|
| 9.0 cm/3½"  | 02-0440-09 | 02-0441-09 | 02-0442-09 | 02-0443-09 |
| 10.5 cm/4¼" | 02-0440-10 | 02-0441-10 | 02-0442-10 | 02-0443-10 |
| 11.5 cm/4½" | 02-0440-11 | 02-0441-11 | 02-0442-11 | 02-0443-11 |



Striaight  
striaight  
striaight  
striaight



Curved  
Gebogene  
courbé  
Curvo



Striaight  
striaight  
striaight  
striaight



Curved  
Gebogene  
courbé  
Curvo

## Fine

## Fine

|            |            |            |            |            |
|------------|------------|------------|------------|------------|
| 9.0cm/3½"  |            |            | 02-0446-09 | 02-0447-09 |
| 10.5cm/4¼" | 02-0444-10 | 02-0445-10 | 02-0446-10 | 02-0447-10 |
| 11.5cm/4½" | 02-0444-11 | 02-0445-11 | 02-0446-11 | 02-0447-11 |

# General Instruments

Eye Scissors  
Augenscherer

Ciseaux Eye  
Tijeras del ojo



02-0448-10 10cm/4" 02-0449-10  
Striaght  
striaght  
striaght  
striaght  
Curved  
Gebogene  
courbé  
Curvo



**Fine**  
9.5 cm/3¾"  
10.5 cm/4¼"  
11.5 cm/4½"  
02-0450-09  
02-0450-10  
02-0450-11  
Striaght  
striaght  
striaght  
striaght



**Fine**  
02-0451-09  
02-0451-10  
02-0451-11  
Curved  
Gebogene  
courbé  
Curvo

Tenotomy Scissors  
Tenotomie Schere  
Ciseaux ténotomie  
Tijeras tenotomía



Stevens  
10.5cm/4¼"  
11.5cm/4½"



Pointed  
spitz  
pointu  
apuntado



02-0452-10  
02-0452-11  
Striaght  
striaght  
striaght  
striaght  
Curved  
Gebogene  
courbé  
Curvo



Blunt  
blunt  
blunt  
blunt

02-0453-10  
02-0453-11  
Striaght  
striaght  
striaght  
striaght



02-0454-10  
02-0454-11  
Striaght  
striaght  
striaght  
striaght  
Curved  
Gebogene  
courbé  
Curvo



02-0456-08  
Striaght  
striaght  
striaght  
striaght



**Bonn**  
8cm/3¼" 02-0457-08  
Curved  
Gebogene  
courbé  
Curvo

# General Instruments

Eye Scissors  
Augenschere

Ciseaux Eye  
Tijeras del ojo



**Graefe**  
02-0458-10  
10.5cm/4¼"



**Wilmer**  
02-0459-10  
10cm/4"



02-0460-11

11.5cm/4½"



02-0461-11



02-0462-11  
Striight  
striight  
striight  
striight

11.5cm/4½"



02-0463-11  
Curved  
Gebogene  
courbé  
Curvo



**La Grange**  
02-0464-11  
11.5cm/4½"



**Chadwick**  
02-0465-11  
11cm/4½"

## Neurosurgical Scissors



Striaight  
striaight  
striaight  
striaight

02-0466-11  
02-0466-13

11cm/4½"  
13cm/5"



Curved  
Gebogene  
courbé  
Curvo

02-0467-11  
02-0467-13



**Potts-de Martel**  
02-0468-21  
21cm/8¼"



**Mills**  
02-0469-21  
21cm/8¼"



Dura Scissors  
Dura Tijeras  
Ciseaux Dura  
Dura Tijeras

**Schmienden-Taylor**  
02-0470-14 14 cm/5½"  
02-0470-17 17.0cm/6 "



02-0471-22  
**Strully**  
22cm/8¾"



02-0472-22



**Dandy**  
02-0473-17  
17cm/6¾"

# General Instruments

Ligature Scissors  
Ligature Schere

Ciseaux Ligatures  
Tijeras de ligadura



**Spencer**  
02-0474-09  
9cm/3½"



**Spencer**  
02-0475-10 10.5cm/4¼"  
02-0475-12 12.0cm/4¾"



**Spencer-Fine**  
02-0476-11 11.5cm/4½"  
02-0476-16 16cm/6¼"



**Littauer**  
02-0477-14  
14cm/5½"



**Shortbent**  
02-0478-09  
9cm/3½"



**Northbent**  
02-0479-12  
12.5cm/5"



**Spencer**  
02-0480-11  
11.5cm/4½"



**Littler**  
02-0481-11  
11.5cm/4½"

## General Instruments

Ligature Scissors  
Ligature Schere

Ciseaux Ligatures  
Tijeras de ligadura



**Heath**  
02-0482-15  
15cm/6"



02-0483-10  
10cm/4"



**Eiselsberg**  
02-0484-11  
11.5cm/4½"



Wire Cutting Scissors  
Ciseaux de coupe de fil  
Tijeras de corte de alambre

**Schoemaker-Loth**  
02-0485-12  
12.5cm/5"



Saw edge  
Saw Rand  
Scie à bord  
Saw borde

**Universal**  
02-0486-12  
12cm/4¾"

# General Instruments

Bandage and Wire Cutting Scissors  
Bandage und Draht Schneidescheren

Bandage et Ciseaux de coupe de câbles  
Vendaje y tijeras de corte de alambre



|       | Universal  | Universal  | Universal  |
|-------|------------|------------|------------|
| Black | 02-0487-01 | 02-0488-01 | 02-0489-01 |
| Blue  | 02-0487-02 | 02-0488-02 | 02-0489-02 |
| Red   | 02-0487-03 | 02-0488-03 | 02-0489-03 |
| Green | 02-0487-04 | 02-0488-04 | 02-0489-04 |

14.5 cm/5¾"

16 cm/6¼"

18 cm/7"

Other Colour Available



**Smith**  
02-0490-17  
17.5 cm/7"



**Harvey**  
02-0491-12  
12.5 cm/5"

Saw edge  
Saw Rand  
Scie à bord  
Saw borde



**Schuknecht**  
02-0492-10  
10 cm/4"

Saw edge  
Saw Rand  
Scie à bord  
Saw borde



02-0493-13 13 cm/5"  
02-0493-15 15 cm/6"

## General Instruments

Bandage Scissors  
Verbandschere

Ciseaux à pansements  
Tijeras de vendaje



**Lister**

02-0494-09 9 cm/3½"  
02-0494-13 13 cm/5"  
02-0494-14 14 cm/5½"  
02-0494-18 18 cm/7"  
02-0494-20 20 cm/8"



**Lister**

02-0495-18  
18 cm/7"



**Lister**

02-0496-18 18.5 cm/7¼"  
02-0496-21 20 cm/8"



**Lister-Excentric**

02-0497-16 16 cm/6¼"  
02-0497-19 19 cm/7½"



**Esmarch**

02-0498-20 20 cm/8"  
02-0498-22 22 cm/8¾"



**Bergmann**

02-0499-23  
23 cm/9"



**Lorenz**

02-0500-23  
23 cm/9"

# General Instruments

Bandage Scissors  
Verbandschere

Ciseaux à pansements  
Tijeras de vendaje



Saw edge  
Saw Rand  
Scie à bord  
Saw borde

02-0501-17  
17 cm/6¾"



**Lange**  
02-0502-18  
18 cm/7"



**Bruns**  
02-0503-01 24 cm/9½" Saw edge  
02-0503-02 24 cm/9½" Smooth  
02-0503-03 24 cm/9½" Smooth



**Smith (Mod. USA)**  
02-0504-16 16 cm/6¼"  
02-0504-18 18 cm/7"  
02-0504-20 20 cm/8"  
02-0504-23 23 cm/9"



**Knowles**  
02-0505-14  
14 cm/5½"



**Knowles**  
02-0506-14  
14 cm/5½"



02-0507-13  
13 cm/5"

## General Instruments

Clothing Scissors, Plaster of Paris and Rib Shears  
Bekleidung Schere, Plaster of Paris und Rib Shears

Ciseaux Vêtements, plâtre de Paris et costotome  
Tijeras de ropa, yeso y tijeras costales



02-0508-20  
20 cm/8"



**Seutin**  
02-0509-23  
23 cm/9"



**Bone Shear**  
02-0510-23  
23 cm/9"



02-0511-22  
22 cm/8¾"



**Gluck**  
02-0512-22  
22 cm/8¾"



**Stille**  
02-0513-21  
21 cm/8¼"



**Stille**  
02-0514-24  
24 cm/9½"

# General Instruments

Plaster of Paris & Rib Shears  
Plaster of Paris & Rib Shears

Plâtre de Paris et costotome  
Yeso de París y cizallas Rib



### Stille

02-0515-23 23 cm/9"  
02-0515-26 26 cm/10¼"  
02-0515-37 37 cm/14½"



02-0516-23 23cm/9"  
02-0516-26 26cm/10¼"  
02-0516-37 37cm/14½"



### Maurer collin

02-0517-24L 24 cm/9½"  
02-0517-30L 30 cm/12"  
02-0517-24R 24 cm/9½"  
02-0517-30R 30 cm/12"



**Beebe**  
10.5 cm/4 1/4"  
Striight  
striaght  
striaght  
striaght

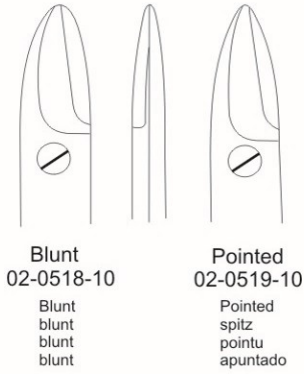

**Blunt**  
02-0518-10  
Blunt  
blunt  
blunt  
blunt

**Pointed**  
02-0519-10  
Pointed  
spitz  
pointu  
apuntado



**Beebe**  
10.5 cm/4 1/4"  
Curved  
Gebogene  
courbé  
Curvo

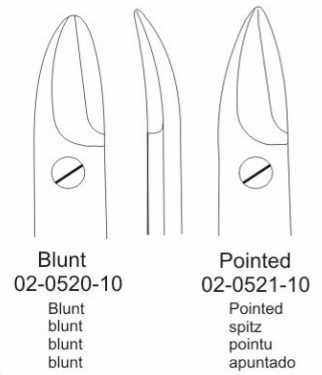

**Blunt**  
02-0520-10  
Blunt  
blunt  
blunt  
blunt

**Pointed**  
02-0521-10  
Pointed  
spitz  
pointu  
apuntado



02-0522-10  
10.5 cm/4 1/4"



**Beebe**  
12 cm/4 3/4"

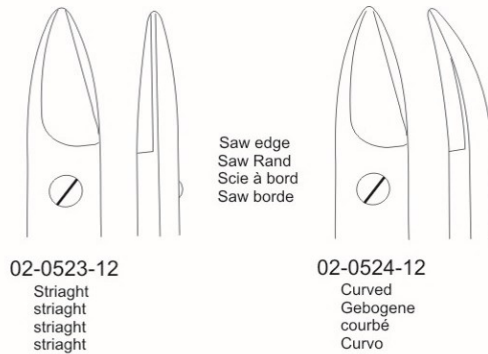

02-0523-12  
Striight  
striaght  
striaght  
striaght

02-0524-12  
Curved  
Gebogene  
courbé  
Curvo

Saw edge  
Saw Rand  
Scie à bord  
Saw borde

# General Instruments

Gum Scissors  
Gum Schere

Ciseaux Gum  
Tijeras de las encías



**Goldmann-Fox**  
02-0525-13  
13 cm/5"



**Goldmann-Fox**  
02-0526-13  
13 cm/5"



**Niro**  
02-0527-14  
14 cm/5½"



**Goldmann-Fox**  
(Spezial)  
02-0528-13  
13 cm/5"



02-0529-11  
11.5 cm/4½"

Fine  
fein  
fin  
multa



**Quinby**  
02-0530-12  
12 cm/4¾"



**Quinby**  
02-0531-12  
12 cm/4¾"

## General Instruments

Gum Scissors  
Gum Schere

Ciseaux Gum  
Tijeras de las encías



Saw edge  
Saw Rand  
Scie à bord  
Saw borde

**Dean**  
02-0532-17  
17 cm/6¾"



**Dean**  
02-0533-17  
17 cm/6¾"



Saw edge  
Saw Rand  
Scie à bord  
Saw borde

**Locklin**  
02-0534-16  
16.5 cm/6½"



**Locklin**  
02-0535-16  
16.5 cm/6½"



**Sullivan**  
02-0536-14  
14 cm/5½"



**Sullivan**  
02-0537-14  
14 cm/5½"



**Neumann**  
02-0538-12  
12 cm/5"



**La Grange**  
02-0539-12  
11 cm/4 1/2"

# General Instruments

Gum and Nail Scissors Ciseaux Gum et ongles  
 Gum-und Nagelscheren Las encías y uñas Tijeras

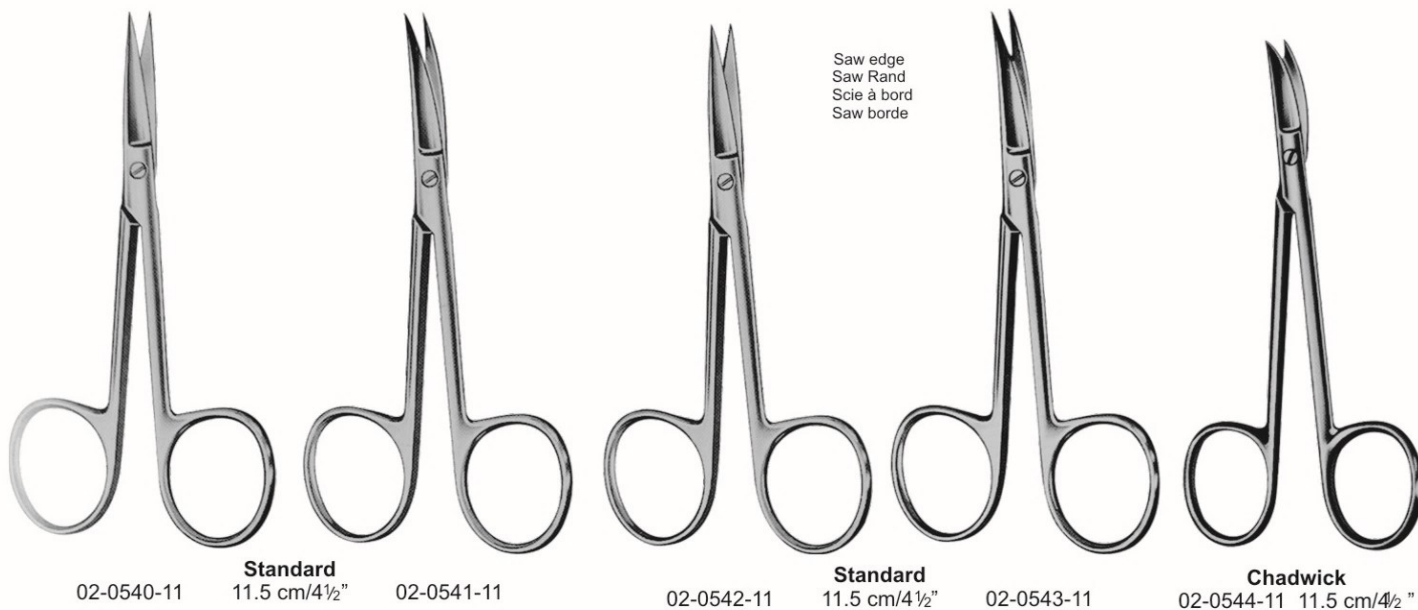

Nail scissors  
 Nagelschere  
 ciseaux à ongles  
 tijeras para las uñas



# General Instruments

Dressing Forceps  
Kornzangen

pinces à pansement  
Pinzas de Vestir



| cm   | in     | Standard   | Standard   | Standard   |            |            | Stille     |
|------|--------|------------|------------|------------|------------|------------|------------|
| 10.5 | 4 1/4" | 03-0550-10 |            |            |            |            |            |
| 11.5 | 4 1/2" | 03-0550-11 | 03-0551-11 |            | 03-0553-11 | 03-0554-11 |            |
| 13.0 | 5"     | 03-0550-13 | 03-0551-13 |            | 03-0553-13 | 03-0554-13 | 03-0555-13 |
| 14.0 | 5 1/2" | 03-0550-14 | 03-0551-14 | 03-0552-14 | 03-0553-14 | 03-0554-14 |            |
| 15.0 | 6"     | 03-0550-15 |            |            |            |            | 03-0555-15 |
| 16.0 | 6 1/4" | 03-0550-16 | 03-0551-16 | 03-0552-16 | 03-0553-16 | 03-0554-16 |            |
| 18.0 | 7"     | 03-0550-18 | 03-0551-18 | 03-0552-18 | 03-0553-18 | 03-0554-18 | 03-0555-18 |
| 20.0 | 8"     | 03-0550-20 |            | 03-0552-20 | 03-0553-20 |            | 03-0555-20 |
| 25.0 | 10"    | 03-0550-25 |            | 03-0552-25 | 03-0553-25 |            |            |
| 30.0 | 12"    | 03-0550-30 |            |            | 03-0553-30 |            |            |

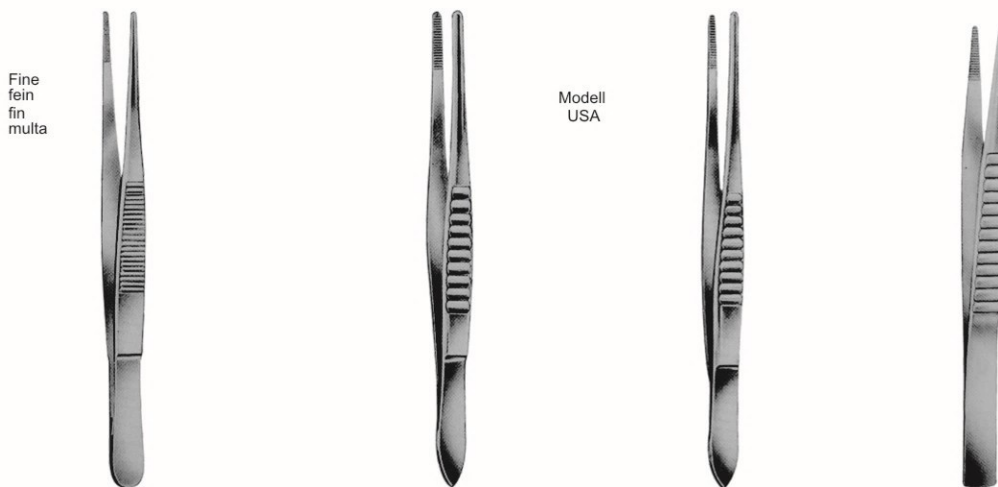

Fine  
fein  
fin  
multa

Modell  
USA

| cm   | in     | Standard   | Narrow     | Engl. Modell |
|------|--------|------------|------------|--------------|
| 11.5 | 4 1/2" | 03-0556-11 |            |              |
| 12.0 | 4 3/4" |            | 03-0557-12 | 03-0558-12   |
| 13.0 | 5"     | 03-0556-13 | 03-0557-13 | 03-0558-13   |
| 14.0 | 5 1/2" | 03-0556-14 | 03-0557-14 | 03-0558-14   |
| 15.0 | 6"     | 03-0556-15 | 03-0557-15 | 03-0558-15   |
| 16.0 | 6 1/4" | 03-0556-16 | 03-0557-16 |              |
| 18.0 | 7"     | 03-0556-18 | 03-0557-18 |              |
| 20.0 | 8"     | 03-0556-20 | 03-0557-20 |              |
| 21.0 | 8 1/4" |            | 03-0557-25 |              |
| 25.0 | 10"    |            | 03-0557-30 |              |
| 30.0 | 12"    |            |            |              |

# General Instruments

Dressing Forceps      pincès à pansement  
Kornzangen              Pinzas de Vestir



cm    in  
12.0   4¾"  
15.5   6"

**Ewald**  
03-0560-12  
03-0560-15



**Jacobson-Adson**  
03-0561-12  
03-0561-15



**Micro-Adson**  
03-0562-12  
03-0562-15



**Adson-Standard**  
03-0563-12  
03-0563-15



**Adson**  
03-0564-12  
03-0564-15



cm    in  
12.0   4¾"  
15.0   6"

**McIndoe**  
03-0565-15



**McIndoe**  
03-0566-15



**Semken**  
03-0567-12      03-0568-12  
03-0567-15      03-0568-15



**Semken**  
03-0569-12  
03-0569-15

# General Instruments

Dressing Forceps  
Kornzangen

pincès à pansement  
Pinzas de Vestir



03-0570-17



03-0571-17



**Taylor**  
03-0572-17  
17.5cm/7"



03-0573-17



03-0574-17

Smooth Jaw  
glatte Jaw  
Moose lisse  
Jaw Smooth



03-0577-20



**Bonney**  
03-0578-18



**Brophy**  
03-0579-18



**Brophy**  
03-0580-18

| cm   | in | Waugh      |
|------|----|------------|
| 15.0 | 6" | 03-0575-15 |
| 18.0 | 7" | 03-0575-18 |
| 20.0 | 8" | 03-0575-20 |

|            |
|------------|
| 03-0576-18 |
| 03-0576-20 |

# General Instruments

Micro Forceps  
Mikropinzette

Micro Pince  
Micro Pinzas



Curved  
Gebogene  
courbé  
Curvo

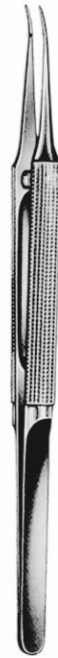
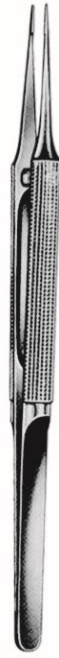

**Gerald**

| cm   | in  |            |            |            |            |            |            |
|------|-----|------------|------------|------------|------------|------------|------------|
| 12.0 | 4¾" |            |            | 03-0584-12 | 03-0585-12 |            |            |
| 13.0 | 5"  | 03-0582-13 | 03-0583-13 |            |            |            |            |
| 15.0 | 6"  | 03-0581-15 |            | 03-0584-15 | 03-0585-15 |            |            |
| 17.5 | 7"  |            |            |            |            | 03-0586-17 | 03-0587-17 |
| 18.0 | 7"  | 03-0581-18 |            | 03-0584-18 | 03-0585-18 |            |            |

Micro Tubal Forceps  
Micro Forceps Tubal  
Micro Pinzas de trompas

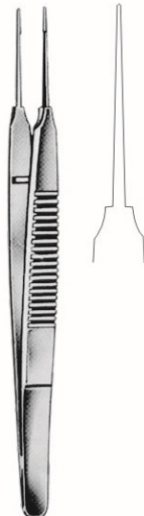

**Austin**  
03-0588-14  
14cm/5½"

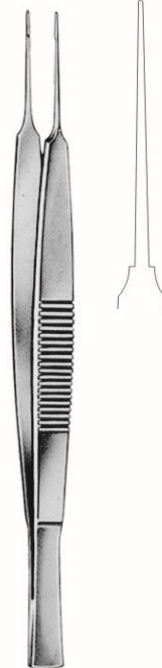

**Austin**  
03-0589-18  
18cm/7"



**Neubuser**  
03-0590-20  
20cm/8"

# General Instruments

Dressing Forceps  
Kornzangen

pincès à pansement  
Pinzas de Vestir



| cm   | in | Cushing    | Cushing    | Cushing    | Cushing    | Cushing-Taylor | Grunwald   |
|------|----|------------|------------|------------|------------|----------------|------------|
| 18.0 | 7  | 03-0591-18 | 03-0592-18 | 03-0593-18 | 03-0594-18 | 03-0595-18     | 03-0596-18 |



| cm   | in     | Wangensteen |            | Potts-Smith |            |  |            |
|------|--------|-------------|------------|-------------|------------|--|------------|
| 15.0 | 6"     | 03-0597-15  |            |             |            |  |            |
| 18.0 | 7"     |             | 03-0598-18 | 03-0599-18  | 03-0600-18 |  | 03-0601-15 |
| 20.0 | 8"     |             |            | 03-0599-21  |            |  | 03-0601-18 |
| 21.0 | 8 1/4" |             |            | 03-0599-25  | 03-0600-21 |  | 03-0601-20 |
| 23.0 | 9"     | 03-0597-23  | 03-0598-23 |             |            |  | 03-0601-23 |
| 25.0 | 10"    | 03-0597-25  |            |             | 03-0600-25 |  | 03-0601-25 |

# General Instruments

Tissue Forceps  
Pinzette

Pince de tissu  
Pinzas de tejido



| cm   | in  | Standard 1:2 | Oehler 1:2 | Standard 2:3 | Standard 3:4 | Standard 4:5 | Standard 1:2 |
|------|-----|--------------|------------|--------------|--------------|--------------|--------------|
| 10.5 | 4¼" | 03-0602-10   |            |              |              |              |              |
| 11.5 | 4½" | 03-0602-11   |            |              |              |              |              |
| 13.0 | 5"  | 03-0602-13   |            | 03-0604-13   | 03-0605-13   | 03-0606-13   | 03-0607-13   |
| 14.0 | 5½" | 03-0602-14   | 03-0603-14 | 03-0604-14   | 03-0605-14   | 03-0606-14   | 03-0607-14   |
| 15.0 | 6"  | 03-0602-15   |            |              |              |              |              |
| 16.0 | 6¼" | 03-0602-16   | 03-0603-16 | 03-0604-16   | 03-0605-16   | 03-0606-16   | 03-0607-16   |
| 18.0 | 7"  | 03-0602-18   | 03-0603-18 | 03-0604-18   |              |              | 03-0607-18   |
| 20.0 | 8"  | 03-0602-20   | 03-0603-20 | 03-0604-20   |              |              | 03-0607-20   |
| 25.0 | 10" | 03-0602-25   | 03-0603-25 | 03-0604-25   |              |              | 03-0607-25   |
| 30.0 | 12" | 03-0602-30   | 03-0603-30 | 03-0604-30   |              |              |              |

# General Instruments

Tissue Forceps  
Pinzette

Pince de tissu  
Pinzas de tejido



Modell  
USA



Modell  
USA



Modell  
USA



Narrow  
schmal  
étroit  
estrecho

**Standard**

| cm   | in                               | 1:2        | 2:3        | 3:4        | 1:2        |
|------|----------------------------------|------------|------------|------------|------------|
| 12.0 | 4 <sup>3</sup> / <sub>4</sub> "  | 03-0608-12 | 03-0609-12 |            |            |
| 13.0 | 5"                               | 03-0608-13 | 03-0609-13 |            | 03-0611-13 |
| 14.0 | 5 <sup>1</sup> / <sub>2</sub> "  | 03-0608-14 | 03-0609-14 | 03-0610-14 | 03-0611-14 |
| 15.5 | 6"                               | 03-0608-15 |            |            | 03-0611-15 |
| 18.5 | 7 <sup>1</sup> / <sub>4</sub> "  | 03-0608-18 | 03-0609-18 |            |            |
| 21.0 | 8 <sup>1</sup> / <sub>4</sub> "  | 03-0608-21 | 03-0609-21 |            |            |
| 25.0 | 10"                              | 03-0608-25 | 03-0609-25 |            |            |
| 31.0 | 12 <sup>1</sup> / <sub>4</sub> " | 03-0608-31 | 03-0609-31 |            |            |



**Lerche**

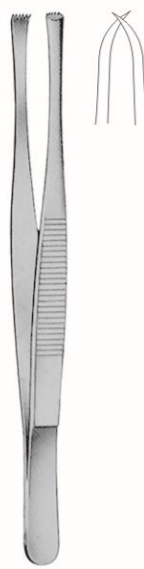

**Stone**



**Treves**

| cm   | in | Lerche     | Stone      | Treves     |
|------|----|------------|------------|------------|
| 13.0 | 5" |            |            | 03-0614-13 |
| 15.0 | 6" | 03-0612-15 | 03-0613-15 | 03-0614-15 |

# General Instruments

Tissue Forceps  
Pinzette

Pince de tissus  
Pinzas de tejido

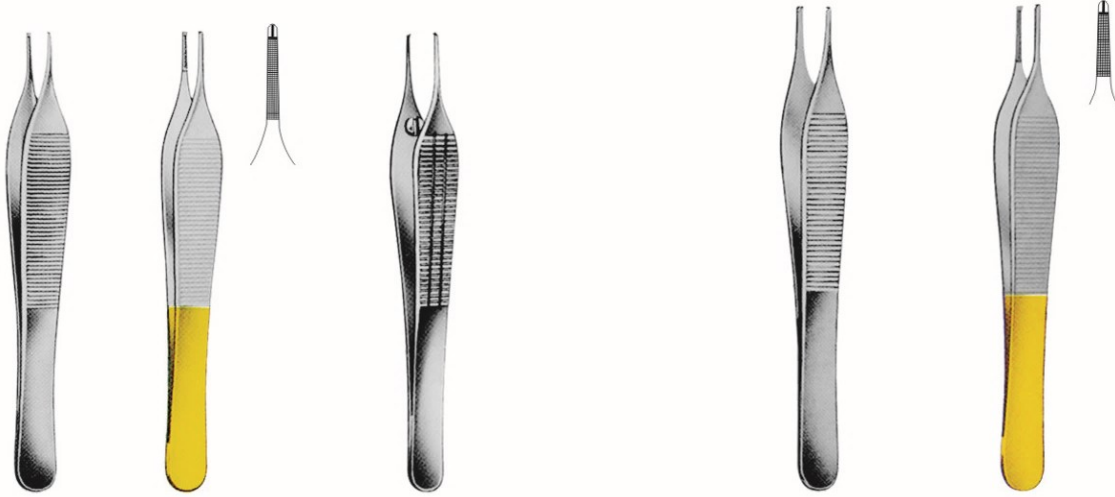

| cm   | in  | Micro-Adson |            |            | Ewald      | Standard-Adson |
|------|-----|-------------|------------|------------|------------|----------------|
| 12.0 | 4¾" | 03-0615-12  | 03-0616-12 | 03-0617-12 | 03-0618-12 | 03-0619-12     |
| 15.5 | 6"  | 03-0615-15  | 03-0616-15 | 03-0617-15 |            | 03-0619-15     |

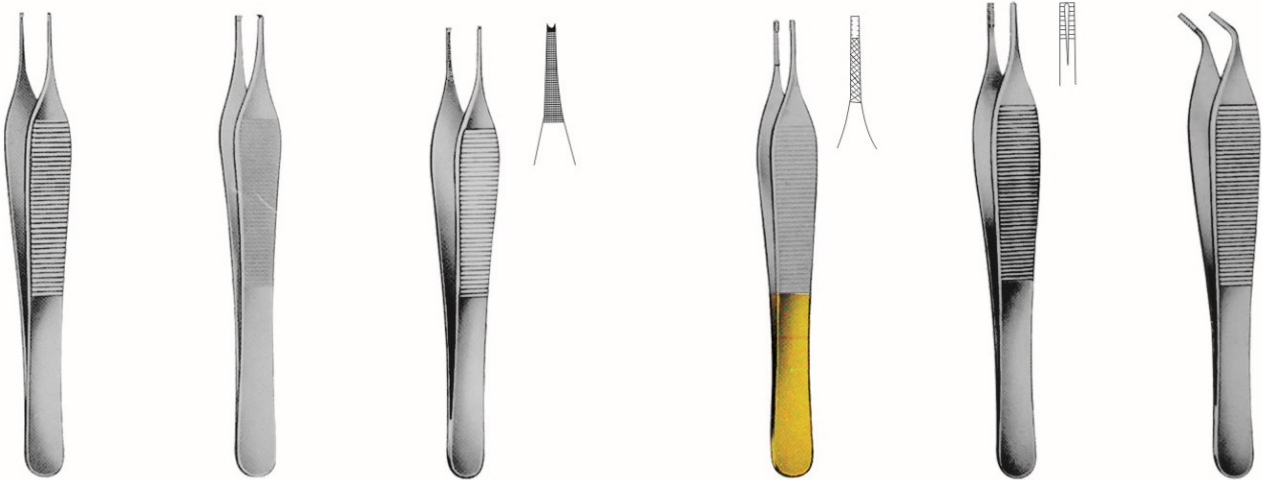

| cm   | in  | Adson      |            |            | Adson-Brown |            |            |
|------|-----|------------|------------|------------|-------------|------------|------------|
| 12.0 | 4¾" | 03-0620-12 | 03-0621-12 | 03-0622-12 | 03-0623-12  | 03-0624-12 | 03-0625-12 |
| 15.0 | 6"  | 03-0620-15 | 03-0621-15 |            |             |            |            |

# General Instruments

Tissue Forceps  
Pinzette

Pince de tissu  
Pinzas de tejido



**Gillies**  
03-0626-15 15 cm/6"



**Gillies**  
03-0627-15 15 cm/6"



**Brown**  
03-0628-15 15 cm/6"  
03-0628-20 20 cm/8"  
03-0628-25 25 cm/10"



**Semken**  
03-0629-12 12 cm/4¾" 03-0630-12  
03-0629-15 15 cm/6" 03-0630-15



**Adlerkreutz**  
03-0631-15 15 cm/6"  
03-0631-20 20 cm/8"  
03-0631-25 25 cm/10"



**Adlerkreutz**  
03-0632-15 15 cm/6"  
03-0632-20 20 cm/8"  
03-0632-25 25 cm/10"



**Taylor**  
03-0633-17 17.5 cm/7"



**Taylor**  
03-0634-17 17.5 cm/7"



**Taylor**  
03-0635-17 17.5 cm/7"



**Taylor**  
03-0636-17 17.5 cm/7"

# General Instruments

Tissue Forceps  
Pinzette

Pince de tissu  
Pinzas de tejido



| cm | in | Waugh      | Brophy     | Brophy     | Gerald     | Gerald     |
|----|----|------------|------------|------------|------------|------------|
| 15 | 6" | 03-0637-15 |            |            |            |            |
| 18 | 7" | 03-0637-18 |            |            | 03-0640-18 | 03-0641-18 |
| 20 | 8" | 03-0637-20 | 03-0638-20 | 03-0639-20 |            |            |

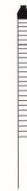

**Cushing**  
03-0642-18  
17.5 cm/7"

**Cushing**  
03-0643-18  
17.5 cm/7"

**Potts-Smith**

03-0644-18  
03-0644-21  
03-0644-25

18 cm/7"  
21 cm/8 1/4"  
25 cm/10"

03-0645-18  
03-0645-21  
03-0645-25

## General Instruments

Fine and Splinter Forceps  
Fein-und Splitter-Zange

Pinces fines et Splinter  
Unas pinzas finas y Splinter



cm in  
10.5 4 1/4" 03-0646-10

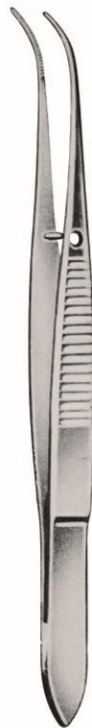

03-0647-10



Graefe  
03-0648-10

With Pin  
mit Pin  
avec Pin  
Con Pin



03-0649-10



03-0650-10



03-0651-10



cm in  
9.0 3 1/2" 03-0652-09  
10.5 4 1/4" 03-0652-10  
11.5 4 1/2" 03-0652-11  
12.5 5" 03-0652-12



03-0653-09  
03-0653-10  
03-0653-11  
03-0653-12



03-0654-09  
03-0654-10  
03-0654-11  
03-0654-12



03-0655-09  
03-0655-10  
03-0655-11  
03-0655-12

# General Instruments

Tissue and Grasping Forceps  
Gewebe- und Faszange

Tissus et Pincés à préhension  
Tejidos y pinzas de agarre

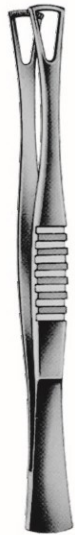

**Duval**  
03-0656-14 14.5 cm/5½"

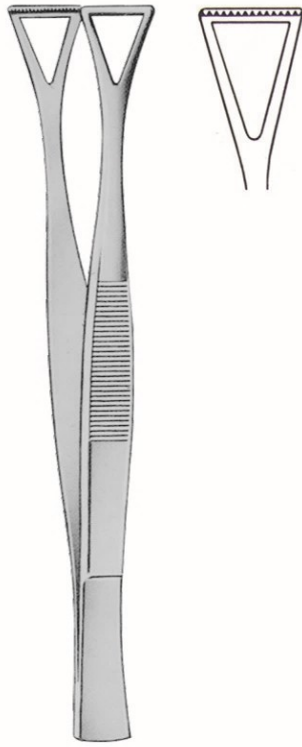

**Collin-Duval**  
03-0657-20 20 cm/8"

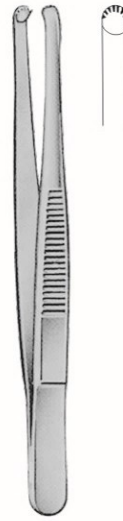

**Durante**  
03-0658-14 14.5 cm/5¾"  
03-0658-16 16.0 cm/6¼"  
03-0658-20 20.0 cm/8"



**Russ. Modell**  
03-0659-15 15 cm/6"  
03-0659-20 20 cm/8"  
03-0659-25 25 cm/10"

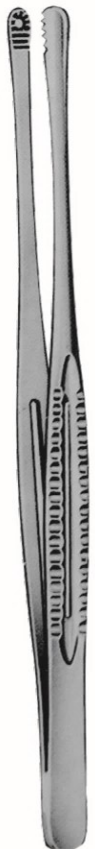

**Mayo**  
03-0660-23 23 cm/9"



**Ferris-Smith**  
18 cm/7"



03-0661-18



03-0662-18



**Ramsay**  
03-0663-17 17.5cm/7"

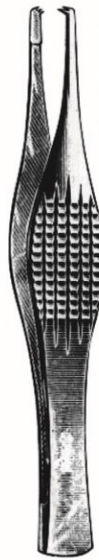

**Lane**  
03-0664-12 12 cm/5"  
03-0664-15 15cm/6"  
03-0664-18 18cm/7"



03-0665-12  
03-0665-15  
03-0665-18

# General Instruments

Tissue Grasping and Watchmakers Forceps  
Tissue Greifen und Uhrmacher Pinzetten

Saisir des tissus et de l'horlogerie Pince  
Tejido Pinzas de presión y Relojeros

Grasping Forceps  
Fasszange  
pince à préhension  
pinzas de agarre



| cm   | in  | Stille-Barraya | Bonney     | Bonney     | Nelson     | Singley-Tuttle |
|------|-----|----------------|------------|------------|------------|----------------|
| 15.0 | 6"  |                |            |            | 03-0669-15 |                |
| 18.0 | 7"  | 03-0666-18     | 03-0667-18 | 03-0668-18 | 03-0669-18 | 03-0670-18     |
| 20.0 | 8"  | 03-0666-20     |            |            | 03-0669-23 |                |
| 23.0 | 9"  |                |            |            |            | 03-0670-23     |
| 25.0 | 10" | 03-0666-25     |            |            |            |                |



No. 3  
03-0671-03  
11.5cm/4½"



No. 4  
03-0672-04  
11.5cm/4½"



No. 5  
03-0673-05  
11.5cm/4½"



No. 7  
03-0674-07  
11.5cm/4½"

Watchmakers Forceps  
Uhrmacher Pinzette  
horlogers Pincés  
Relojeros Pinzas

# General Instruments

Splinter Forceps  
Splitter-Zange

Pinces à échardes  
Pinzas de Splinter



**Feilchenfeld**

- 03-0675-07 7.5cm/3"
- 03-0675-09 9.0cm/3½"
- 03-0675-11 11.5cm/4½"



**Hunter**

- 03-0676-10 10.5cm/4¼"
- 03-0677-10



**Walter-Carmalt**

- 03-0678-10 10.5cm/4¼"
- 03-0679-10



**Peet**

- 03-0680-11 11.5cm/4 1/2"



- 03-0681-13 with out ratchet
- 03-0682-13 with ratchet



03-0683-13  
13cm/5¼"  
45°



03-0684-13  
13cm/5¼"  
90°



**Ralk**

- 03-0685-15 15cm/6"



**Ralk**

- 03-0686-15 15cm/6"

## General Instruments

Ligature and Cilia Forceps  
Ligature und Cilia Forceps

Pince de ligature et Cilia  
Ligadura y Cilia Pinzas



**Ochsner**  
03-0687-14  
14.5cm/5¾"



**Adson**  
03-0688-12  
12cm/4¾"



**Adson**  
03-0689-12  
12cm/4¾"

Cilia Forceps  
Cilia Forceps  
Pince à cils  
Pinzas Cilia



**Beaupre**  
03-0690-12  
12cm/4¾"

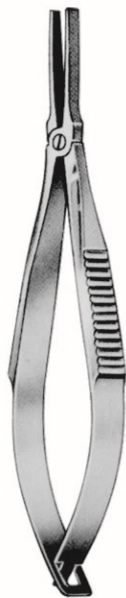

**Henry**  
03-0691-12  
12cm/4¾"



**Gradle**  
03-0692-09  
9.5cm/3¾"



**Barraquer**  
03-0693-10  
10.5cm/4¼"



**Bennett**  
03-0694-07  
7cm/2¾"

# General Instruments

Silia and Cover Glass Forceps  
Silia und Deckglaspinzetten

Silia et Pince verre de couverture  
Silia y el Pinzas Cubierta de vidrio

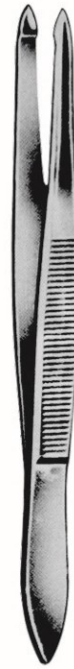

cm in **Beer**  
9.0 3½" 03-0695-09

**Douglass**  
03-0696-09

**Ziegler**  
03-0697-09

03-0698-09

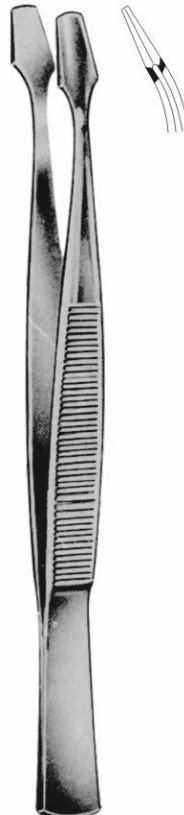
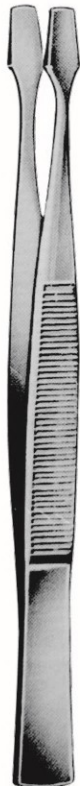

**Kuehne**  
03-0699-10  
10.5cm/4¼"

**Kuehne**  
03-0700-10  
10.5cm/4¼"

03-0701-10  
10.5cm/4¼"



**Debaquey**

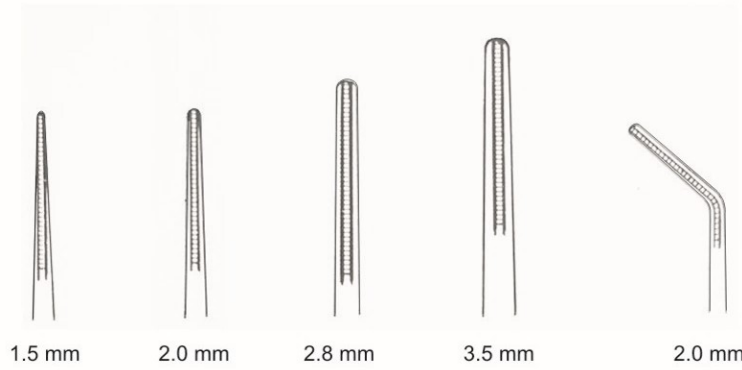

1.5 mm      2.0 mm      2.8 mm      3.5 mm      2.0 mm



**Adson**

03-0707-12 12cm/4¾"  
03-0707-15 15cm/6"

| cm   | in  | 1.5 mm     | 2.0 mm     | 2.8 mm     | 3.5 mm     | 2.0 mm     |
|------|-----|------------|------------|------------|------------|------------|
| 16.0 | 6¼" | 03-0702-16 | 03-0703-16 | 03-0704-16 | 03-0705-16 | 03-0706-16 |
| 20.0 | 8"  | 03-0702-20 | 03-0703-20 | 03-0704-20 | 03-0705-20 | 03-0706-20 |
| 24.0 | 9½" | 03-0702-24 | 03-0703-24 | 03-0704-24 | 03-0705-24 | 03-0706-24 |
| 30.0 | 12" | 03-0702-30 | 03-0703-30 | 03-0704-30 | 03-0705-30 | 03-0706-30 |



**Troeltsch (Wild)**

**Troeltsch**

**Lucae**

**Lucae**

**Jansen (Gruenwald)**

**Jansen**

| cm   | in  | Troeltsch (Wild) | Troeltsch  | Lucae      | Lucae      | Jansen (Gruenwald) | Jansen     |
|------|-----|------------------|------------|------------|------------|--------------------|------------|
| 11.5 | 4½" | 03-0708-11       |            |            |            |                    |            |
| 12.0 | 4¾" | 03-0708-12       | 03-0709-12 | 03-0710-14 | 03-0711-14 |                    |            |
| 14.0 | 5½" |                  |            |            |            |                    |            |
| 15.0 | 6"  | 03-0708-15       |            |            |            |                    |            |
| 16.0 | 6¼" |                  |            |            |            | 03-0712-16         | 03-0713-16 |
| 18.0 | 7"  | 03-0708-18       |            |            |            | 03-0712-18         | 03-0713-18 |
| 20.0 | 8"  |                  |            |            |            | 03-0712-20         | 03-0713-20 |

# General Instruments

Atraumatic Dressing Forceps, Desiccating Forceps  
Atrauma Tissue Dressing und Tupferzange

Vinaigrette tissus nasaux et atraumatique pincés à pansement  
Atrauma Aderezo de tejidos y Pinzas nasales Vestir

**Accu-Med**<sup>®</sup>  
Instrument Co.



03-0714-18 18 cm/ 7"



**JOBOMA**



03-0715-18 18 cm/ 7"



1: 2

**JOBOMA**



03-0716-18 18 cm/ 7"

1: 2

**JOBOMA**

# General Instruments

Micro Dressing Forceps  
Micro Kornzange

Micro pince à pansement  
Micro Pinza Dressing



1/2



Tips  
Tipps  
conseils  
consejos

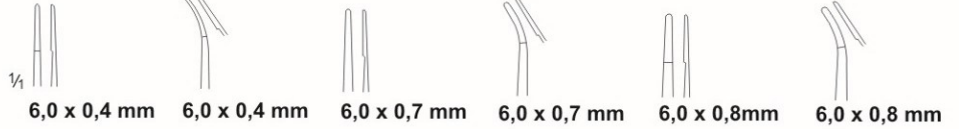

|          | cm | in     |            |            |            |                       |
|----------|----|--------|------------|------------|------------|-----------------------|
| Steel    | 15 | 6"     | 03-0717-15 | 03-0718-15 | 03-0719-15 | 03-0720-15            |
| Titanium | 15 | 6"     | 03-0717-15 | 03-0718-15 |            | 03-0721-15 03-0722-15 |
| Steel    | 18 | 7"     | 03-0717-18 | 03-0718-18 | 03-0719-18 | 03-0720-18            |
| Titanium | 18 | 7"     | 03-0717-18 | 03-0718-18 |            | 03-0721-15 03-0722-18 |
| Steel    | 21 | 8 1/4" |            |            | 03-0719-21 | 03-0720-21            |
| Titanium | 21 | 8 1/4" | 03-0717-21 | 03-0718-21 |            | 03-0721-21 03-0722-21 |
| Steel    | 23 | 9"     |            |            | 03-0719-23 | 03-0720-23            |

**Titanium**

# General Instruments

Micro Dissecting Forceps  
Micro Dissektionszangen

Micro Pince à dissection  
Micro Pinza de disección



|          | cm in |        | 6,0 x 0,4 mm |            | 6,0 x 0,7 mm |            | 6,0 x 0,8 mm |            |
|----------|-------|--------|--------------|------------|--------------|------------|--------------|------------|
|          | cm    | in     | 03-0723      | 03-0724    | 03-0725      | 03-0726    | 03-0727      | 03-0728    |
| Steel    | 15    | 6"     | 03-0723-15   | 03-0724-15 | 03-0725-15   | 03-0726-15 |              |            |
| Titanium | 15    | 6"     | 03-0723-15   | 03-0724-15 |              |            | 03-0727-15   | 03-0728-15 |
| Steel    | 18    | 7"     | 03-0723-18   | 03-0724-18 | 03-0725-18   | 03-0726-18 |              |            |
| Titanium | 18    | 7"     | 03-0723-18   | 03-0724-18 |              |            | 03-0727-18   | 03-0728-18 |
| Steel    | 21    | 8 1/4" |              |            | 03-0725-21   | 03-0726-21 |              |            |
| Titanium | 21    | 8 1/4" | 03-0723-21   | 03-0724-21 |              |            | 03-0727-21   | 03-0728-21 |
| Steel    | 23    | 9"     |              |            | 03-0725-23   | 03-0726-23 |              |            |

**Titanium**

# General Instruments

Bulldog Hemostatic Forceps  
Bulldog Hämostatische Forceps

Bulldog Forcepsg hémostatique  
Bulldog hemostático Forcepsg



**Dieffenbach**  
04-0730-03  
3.5cm/1½"  
04-0730-05  
5cm/2"



**Dieffenbach**  
04-0731-03  
3.5cm/1½"  
04-0731-05  
5cm/2"



**Dieffenbach**  
04-0733-06  
6cm/2½"



**Dieffenbach**  
04-0734-06  
6cm/2½"



**Johns-Hopkins**

Straight  
gerade  
droit  
recto

- 04-0732-01 38mm/1½"
- 04-0732-02 51mm/2"
- 04-0732-03 57mm/2¼"
- 04-0732-04 63mm/2½"
- 04-0732-05 70mm/2¾"
- 04-0732-06 75mm/3"
- 04-0732-07 90mm/3½"

Curved  
Gebogene  
courbé  
Curvo

- 04-0735-01 38mm/1½"
- 04-0735-02 51mm/2"
- 04-0735-03 57mm/2¼"
- 04-0735-04 63mm/2½"
- 04-0735-05 70mm/2¾"
- 04-0735-06 75mm/3"
- 04-0735-07 90mm/3½"



04-0736-10  
24.5 cm 9 3/4"



**Carrel**  
04-0737-10  
10cm/4"

Haemorrhoidal Clamps  
Hämorrhoiden Clamps  
Pincès hémorroïdaires  
Abrazaderas hemorroidales



**Chaput**  
04-0738-13  
13cm/5"



**Tuffier**  
04-0739-13  
13cm/5"



**Pratt**  
04-0740-15  
15cm/6"

# General Instruments

Hemostatic Forceps  
Arterienklemmen

pinces hémostatiques  
pinzas hemostáticas



**Pennington**  
04-0741-15 15 cm/6"  
04-0741-20 20cm/8"



04-0742-00  
12.5 cm/5"

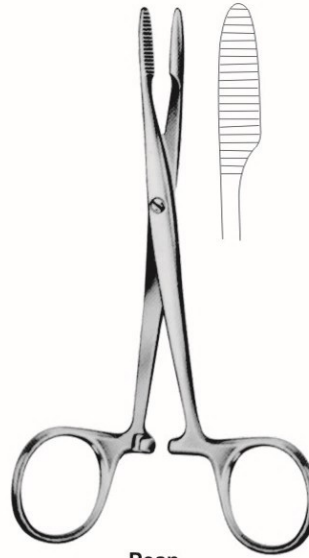

**Pean**  
04-0743-00  
16.5cm/6 3/4"

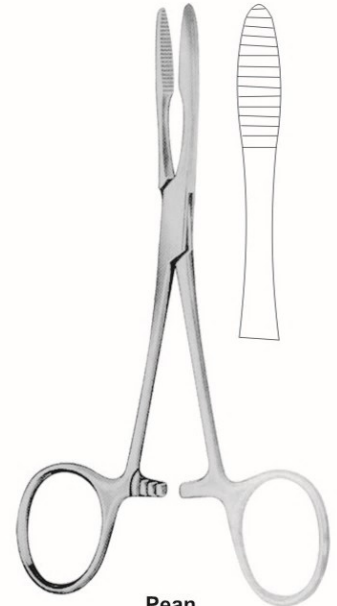

**Pean**  
04-0744-14 14cm/5 1/2"  
04-0745-16 16cm/6 1/2"

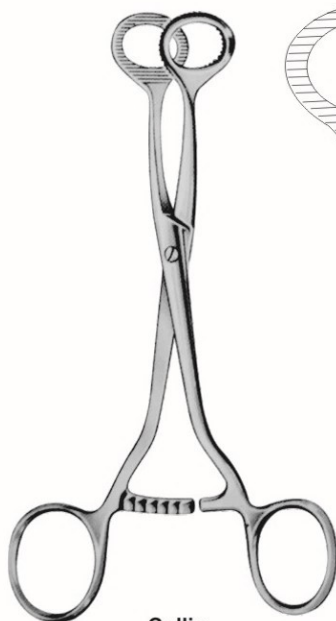

**Collin**  
04-0746-15  
15.5 cm/6"



**Collin**  
04-0747-14  
14 cm/5 1/2"



**Collin**  
04-0748-16  
16.5 cm/6 1/2"

## General Instruments

Hemostatic Forceps  
Arterienklemmen

pinces hémostatiques  
pinzas hemostáticas



**Micro-Mosquito**  
10 cm/4"  
12.5 cm/5 "



04-0749-10  
04-0749-12



04-0751-10  
04-0751-12



04-0750-10  
04-0750-12



04-0752-10  
04-0752-12

Very fine  
sehr feine  
très bien  
Muy bien



**Jacobson-Halstead**  
12.5 cm/5"



04-0753-13



04-0754-13



**Hartmann**  
10 cm/4"



04-0755-10



04-0757-10



04-0756-10



04-0758-10



**Halstead-Mosquito**  
12.5 cm/5"  
14 cm/5 1/2"



04-0759-12  
04-0759-14



04-0761-12  
04-0761-14



04-0760-12  
04-0760-14



04-0762-12  
04-0762-14

# General Instruments

Hemostatic Forceps  
Arterienklemmen

pincas hémostatiques  
pinzas hemostáticas



**Halstead-Mosquito**  
18 cm/7"  
21 cm/8 1/4"

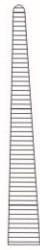

04-0763-18  
04-0763-21



04-0765-18  
04-0765-21



04-0764-18  
04-0764-21



04-0766-18  
04-0766-21

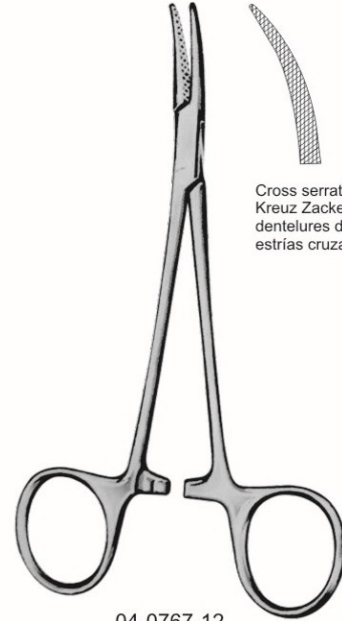

04-0767-12  
12 cm / 4 3/4"



Cross serrations  
Kreuz Zacken  
dentelures de la Croix-  
estrias cruzadas



**Kally**  
14 cm/5 1/2"  
**Kally-Rankin**  
16 cm/6 1/4"



04-0768-14



14 cm/5 1/2" 04-0769-14



04-0768-16



16 cm/6 1/4" 04-0769-16

# General Instruments

Hemostatic Forceps  
Arterienklemmen

pincas h emostatiques  
pinzas hemost aticas



**Crile**  
14 cm/5½"

**Crile-Rankin**  
16 cm/6¼"



04-0770-14 14 cm/5½"



04-0772-14



04-0771-16 16 cm/6¼"



04-0773-16



**Baby-Crile**  
14 cm/5½"



04-0774-14



04-0775-14



**Crile**  
14 cm/5½"

**Crile-Rankin**  
16 cm/6¼"



04-0776-14 14 cm/5½"



04-0777-14



04-0778-16 16 cm/6¼"



04-0779-16



**Baby-Crile**  
14 cm/5½"



04-0780-14



04-0781-14

# General Instruments

Hemostatic Forceps  
Arterienklemmen

pinces hémostatiques  
pinzas hemostáticas



**Coller-Crile**

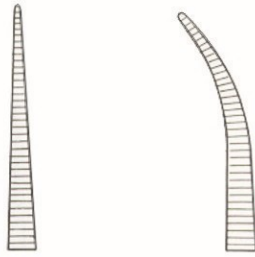

04-0782-14 14 cm/5 1/2" 04-0783-14

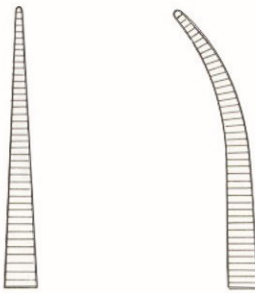

04-0784-16 16 cm/6 1/4" 04-0785-16



**Coller-Crile**  
04-0786-16  
16 cm/6 1/4"

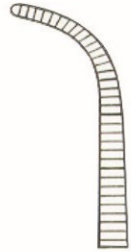

**Leriche**  
15 cm/6"



04-0787-15



04-0788-15



04-0789-15



04-0790-15



**Providence**  
14 cm/5 1/2"



04-0791-14



04-0792-14

# General Instruments

Hemostatic Forceps  
Arterienklemmen

pinces hémostatiques  
pinzas hemostáticas

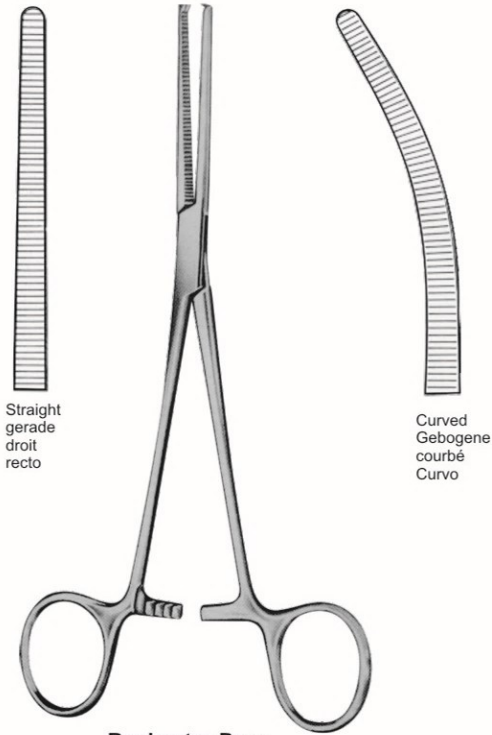

Straight  
gerade  
droit  
recto

Curved  
Gebogene  
courbé  
Curvo

**Rochester-Pean**

| STR        | WD         | cm   | in      |
|------------|------------|------|---------|
| 04-0793-13 | 04-0794-13 | 13.0 | 5"      |
| 04-0793-14 | 04-0794-14 | 14.0 | 5 1/2"  |
| 04-0793-16 | 04-0794-16 | 16.0 | 6 1/4"  |
| 04-0793-18 | 04-0794-18 | 18.0 | 7"      |
| 04-0793-20 | 04-0794-20 | 20.0 | 8"      |
| 04-0793-22 | 04-0794-22 | 22.0 | 8 3/4"  |
| 04-0793-24 | 04-0794-24 | 24.0 | 9 1/2"  |
| 04-0793-26 | 04-0794-26 | 26.0 | 10 1/4" |
| 04-0793-30 | 04-0794-30 | 30.0 | 12"     |

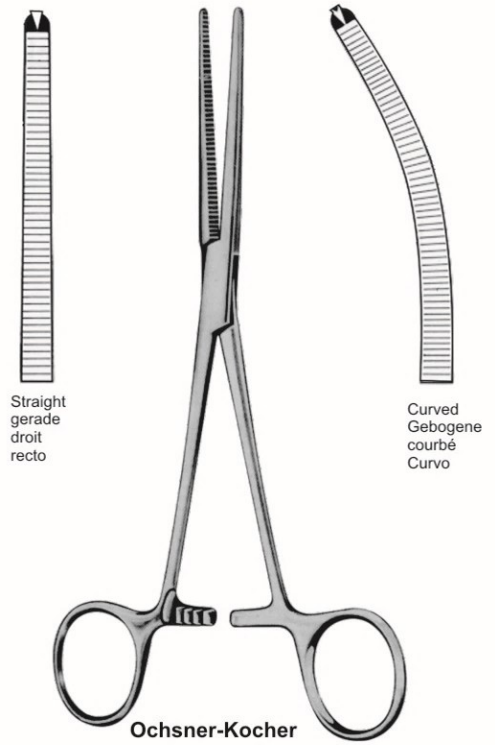

Straight  
gerade  
droit  
recto

Curved  
Gebogene  
courbé  
Curvo

**Ochsner-Kocher**

| STR        | WD         |
|------------|------------|
| 04-0795-13 | 04-0796-13 |
| 04-0795-14 | 04-0796-14 |
| 04-0795-16 | 04-0796-16 |
| 04-0795-18 | 04-0796-18 |
| 04-0795-20 | 04-0796-20 |
| 04-0795-22 | 04-0796-22 |
| 04-0795-24 | 04-0796-24 |
| 04-0795-26 | 04-0796-26 |
| 04-0795-30 | 04-0796-30 |

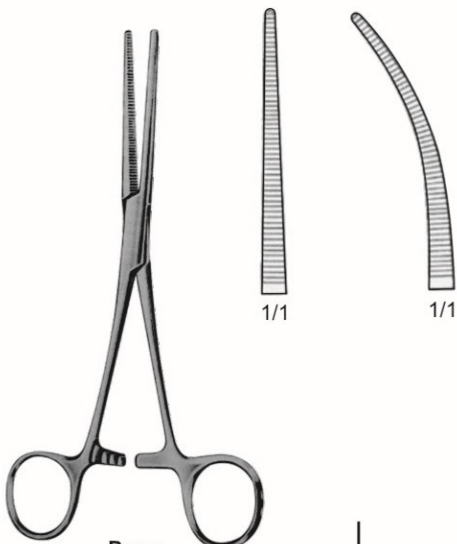

1/1

1/1

Fine  
feine  
fin  
multa

**Pean**

| cm   | in     |
|------|--------|
| 13.0 | 5"     |
| 14.0 | 5 1/2" |
| 16.0 | 6 1/4" |

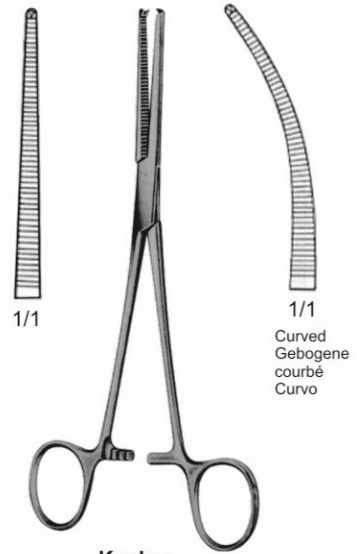

1/1

1/1  
Curved  
Gebogene  
courbé  
Curvo

**Kocher**

|            |            |
|------------|------------|
| 04-0799-13 | 04-0800-13 |
| 04-0799-14 | 04-0800-14 |
| 04-0799-16 | 04-0800-16 |

# General Instruments

Hemostatic Forceps  
Arterienklemmen

pincas hémostatiques  
pinzas hemostáticas

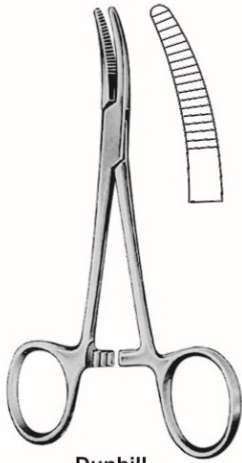

**Dunhill**  
04-0801-13  
13cm/5"

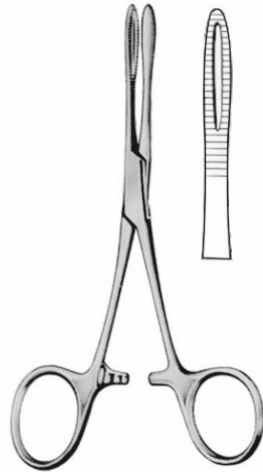

**Kronlein**  
04-0802-13  
13cm/5"

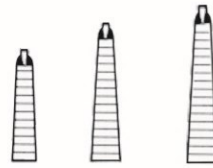

Tendon Seizing Forcep  
Sehnen ergriff forcep  
Tendon saisir pince  
Tendon apoderarse fórceps

**Brand**  
04-0803-15 15cm/6"  
04-0803-19 19cm/7 1/2"  
04-0803-24 24cm/9 1/2"

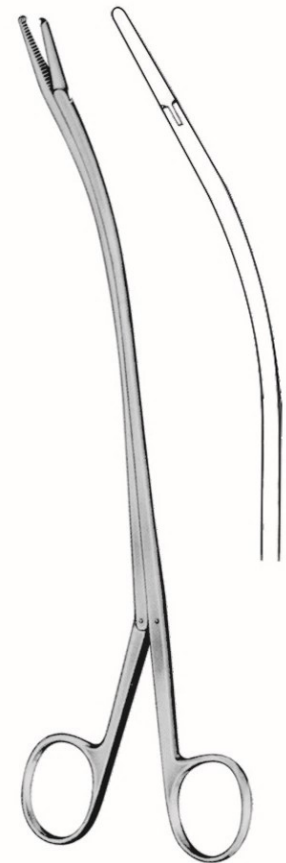

**Brand**  
04-0804-15 15cm/6"  
04-0804-19 19cm/7 1/2"  
04-0804-24 24cm/9 "

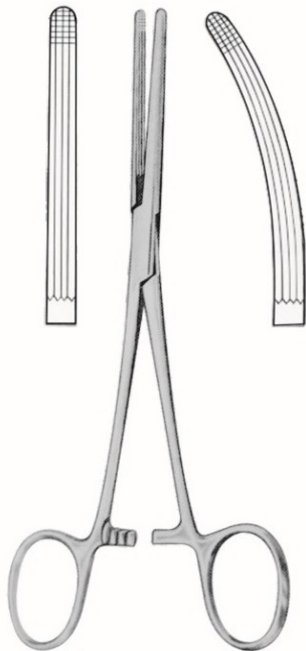

**Rochester-Carmalt**  
04-0805-16  
16cm/6 1/4"  
20cm/8"

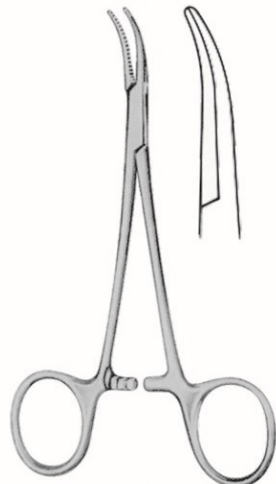

**Mosquito-Dandy**  
04-0806-12  
12cm/4 3/4"

Lateral Curved  
Gekrümmte seitlichen  
latérale incurvée  
lateral curvo



**Dandy**  
14cm/5 1/2"

04-0807-14

04-0808-14

## General Instruments

Hemostatic Dissecting and Ligature Forceps  
Hämostatische Dissecting und Ligaturklemmen

Dissection Pince hémostatique et ligatures  
La disección y pinzas hemostáticas ligaduras



**Adson**  
18.5cm/7¼"

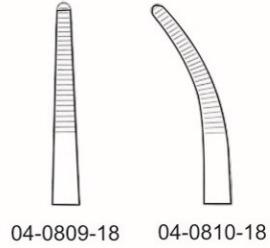

04-0809-18 04-0810-18

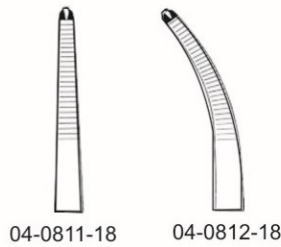

04-0811-18 04-0812-18

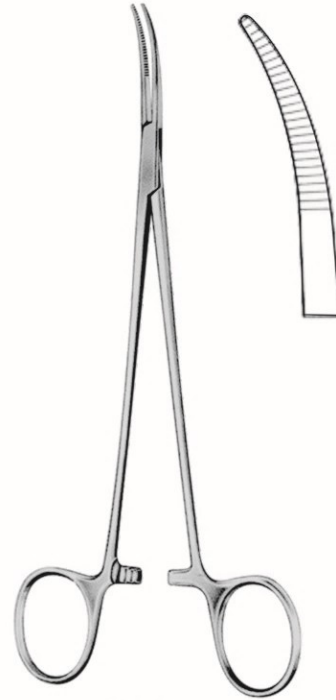

**Nissen**  
04-0813-18 18.5cm/7¼"  
04-0814-22 22.0cm/8¾"

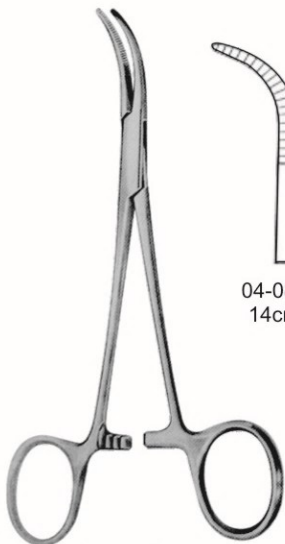

**Baby-Adson**

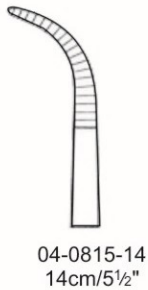

04-0815-14  
14cm/5½"

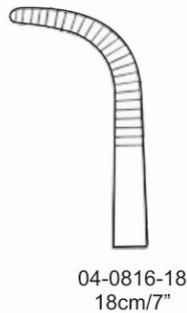

04-0816-18  
18cm/7"

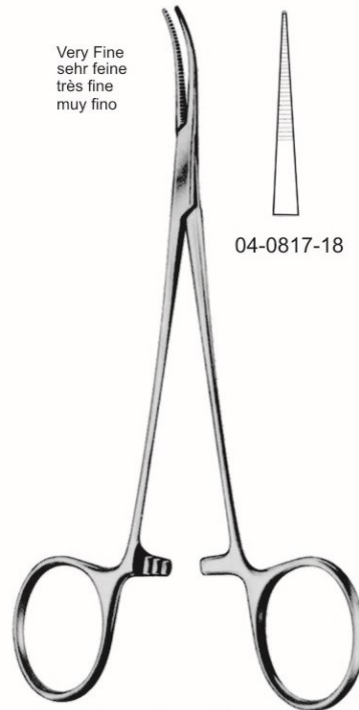

**Jacobson-Adson**  
18cm/7"

Very Fine  
sehr feine  
très fine  
muy fino

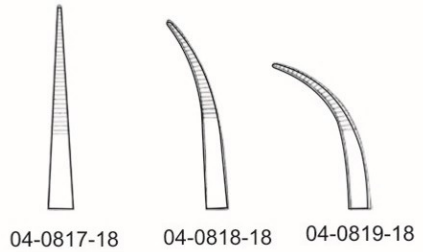

04-0817-18 04-0818-18 04-0819-18

# General Instruments

Hemostatic Forceps  
Arterienklemmen

pincas hémostatiques  
pinzas hemostáticas



**Lovelace**  
04-0820-15  
15.5cm/6"



**Dixon-Lovelace**  
04-0821-16  
16cm/6¼"



**Dixon-Lovelace**  
04-0822-16  
16cm/6¼"



**Bainbridge**  
15cm/6"  
18cm/7"



04-0823-15  
04-0823-18



04-0824-15  
04-0824-18



**Fuchsig**  
04-0825-19  
19cm/7½"

# General Instruments

Hemostatic Forceps  
Arterienklemmen

pincas hémostatiques  
pinzas hemostáticas



**Schnidt**  
19cm/7½"



04-0826-19

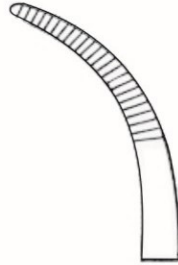

04-0827-19

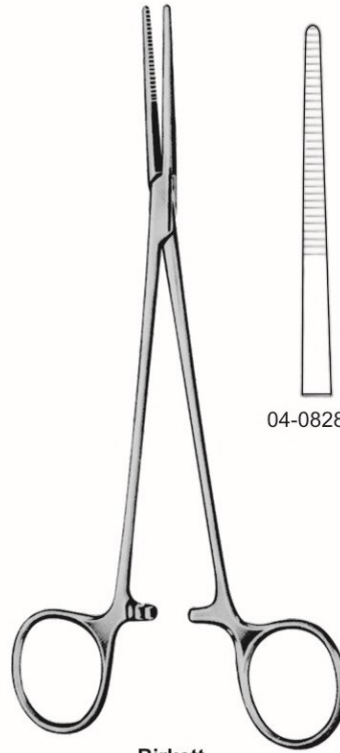

**Birkett**  
19cm/7½"



04-0828-19



04-0829-19



**Bengolea**



|           |            |            |            |            |
|-----------|------------|------------|------------|------------|
| 20cm/8"   | 04-0830-20 | 04-0831-20 | 04-0832-20 | 04-0833-20 |
| 22cm/8¾"  | 04-0830-22 | 04-0831-22 | 04-0832-22 | 04-0833-22 |
| 24cm/9½"  | 04-0830-24 | 04-0831-24 | 04-0832-24 | 04-0833-24 |
| 26cm/10¼" | 04-0830-26 | 04-0831-26 | 04-0832-26 | 04-0833-26 |

# General Instruments

Hemostatic Forceps  
Arterienklemmen

pinces hémostatiques  
pinzas hemostáticas



**Bridge**  
27cm/10½"

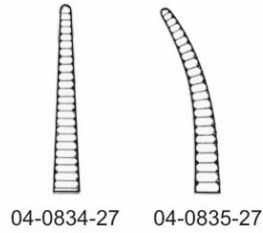

**Roberts**  
22cm/8¾"

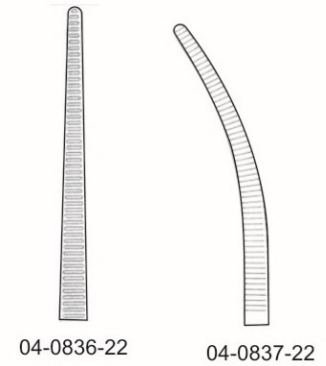

**Kelly**

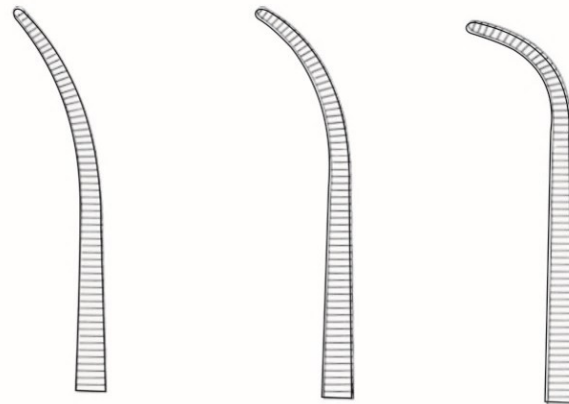

|          |            |            |            |
|----------|------------|------------|------------|
| 19cm/7½" | 04-0838-19 | 04-0839-19 | 04-0840-19 |
| 22cm/8¾" | 04-0838-22 | 04-0839-22 | 04-0840-22 |
| 24cm/9½" | 04-0838-24 | 04-0839-24 | 04-0840-24 |

## General Instruments

Bronchus and Hemostatic Forceps  
Bronchien und Arterienklemmen

Pince hémostatique des bronches et  
Pinzas de bronquios y hemostático

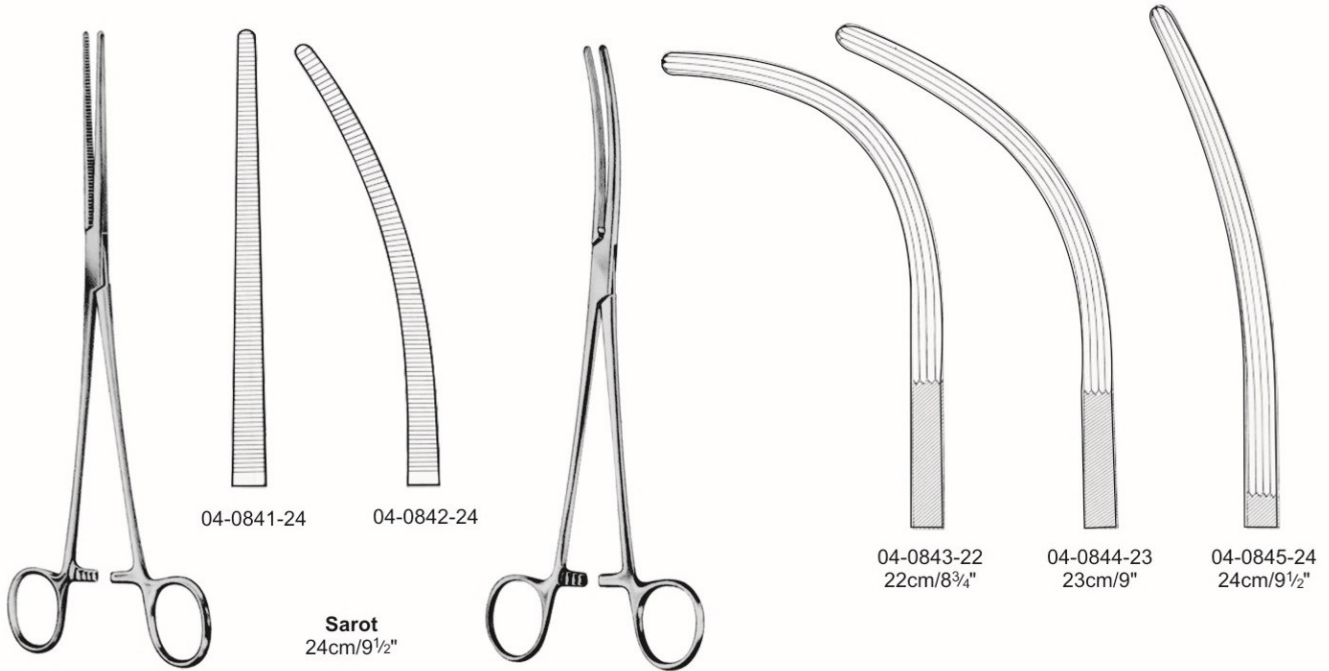

### Crafoord-Sellors

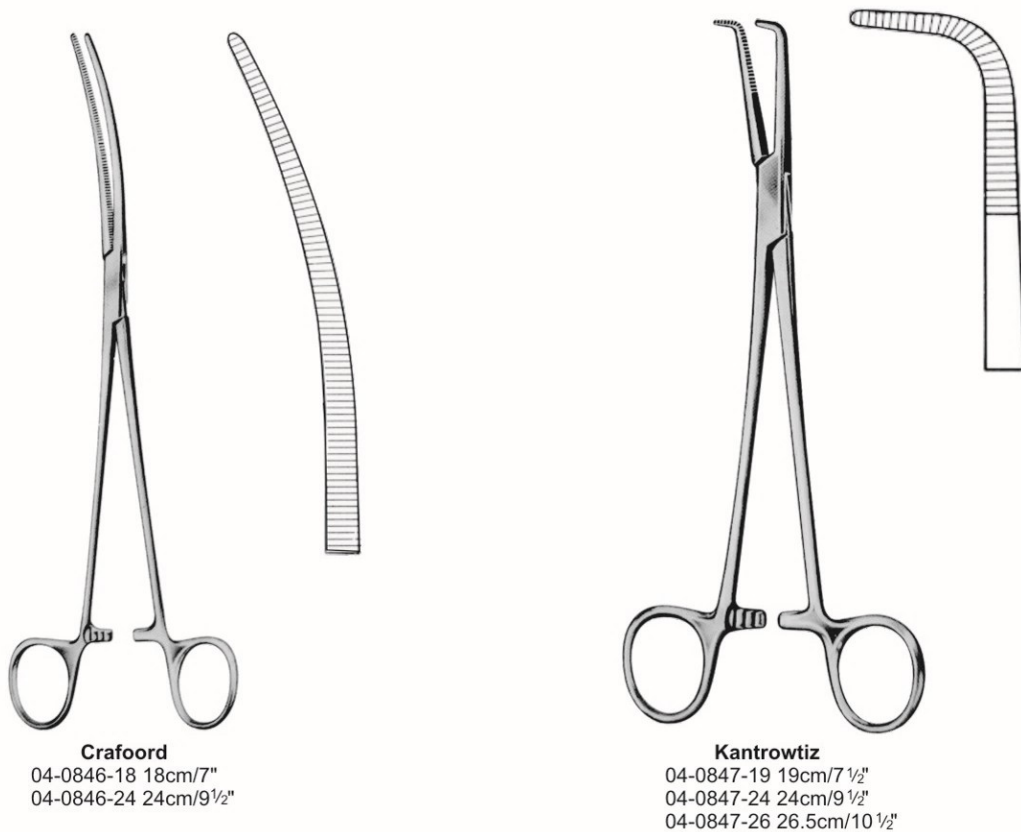

# General Instruments

Dissecting and Ligature Forceps  
Anatomische und Ligaturklemmen

Dissection et Pince Ligatures  
Pinzas de disección y ligadura



**Johns Hopkins**  
04-0848-20  
20cm/8"

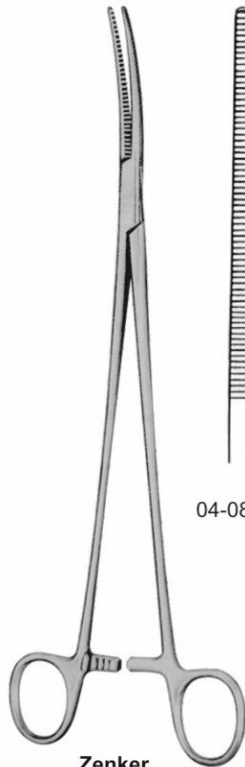

**Zenker**  
29.5cm/11½"

04-0849-29



04-0850-29

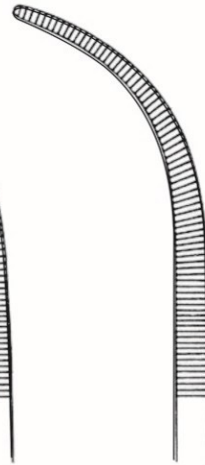

04-0851-29

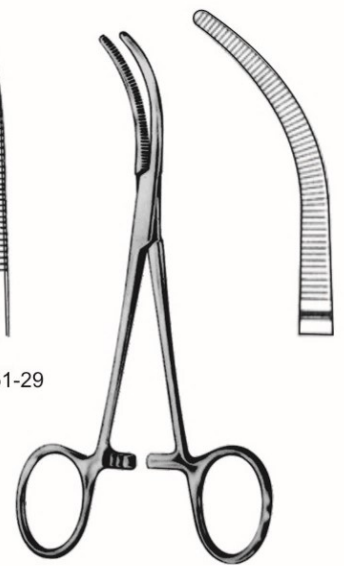

**Baby-Overholt**  
04-0852-13  
13.5cm/5¼"



**Rumel**  
23cm/9"

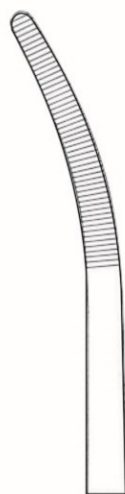

04-0853-23

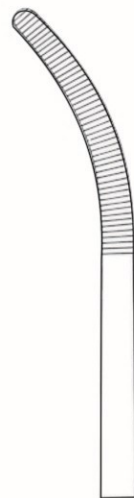

04-0854-23



04-0855-23



04-0856-23

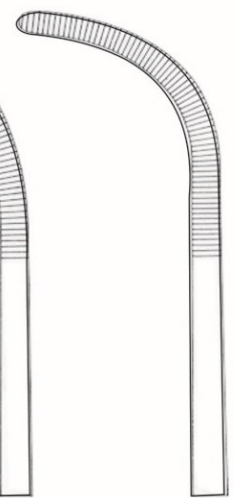

04-0857-23

## General Instruments

Dissecting and Ligature Forceps  
Anatomische und Ligaturklemmen

Dissection et Pince Ligatures  
Pinzas de disección y ligadura



Overholt-Slim



04-0858-18  
18.5cm/7 1/4"

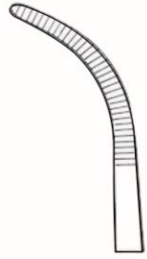

04-0859-20  
20.5cm/8"

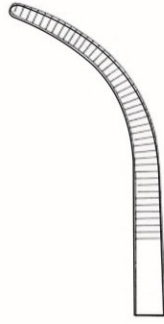

04-0860-21  
21cm/8 1/4"

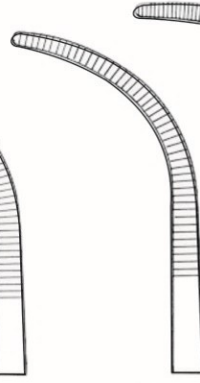

04-0861-21  
21.5cm/8 1/2"

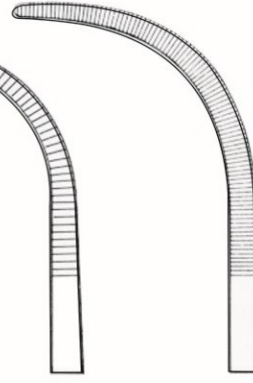

04-0862-24  
24cm/9 1/2"



Overholt-Slim



04-0863-18  
18.5cm/7 1/4"



04-0864-20  
20.5cm/8"

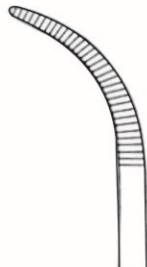

04-0865-21  
21cm/8 1/4"

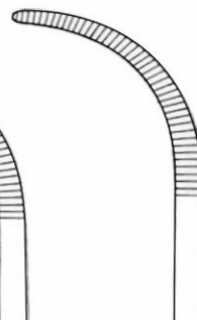

04-0866-21  
21.5cm/8 1/4"



# General Instruments

Dissecting and Ligature Forceps  
Anatomische und Ligaturklemmen

Dissection et Pince Ligatures  
Pinzas de disección y ligadura



**Overholt-Geissendorfer**  
21cm/8¼"  
27cm/10½"

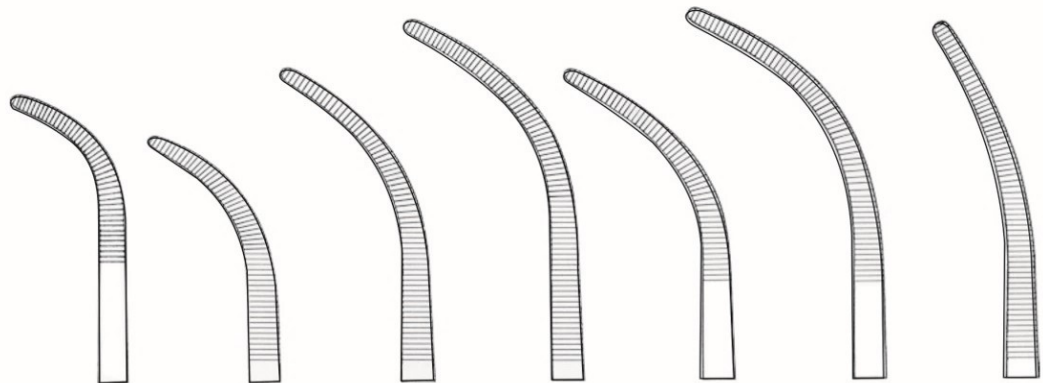

04-0867-21  
04-0867-27

04-0868-21  
04-0868-27

04-0869-21  
04-0869-27

04-0870-21  
04-0870-27

04-0871-21  
04-0871-27

04-0872-21  
04-0872-27

04-0873-21  
04-0873-27



**Overholt-Mixter**  
04-0874-21  
21cm/8¼"

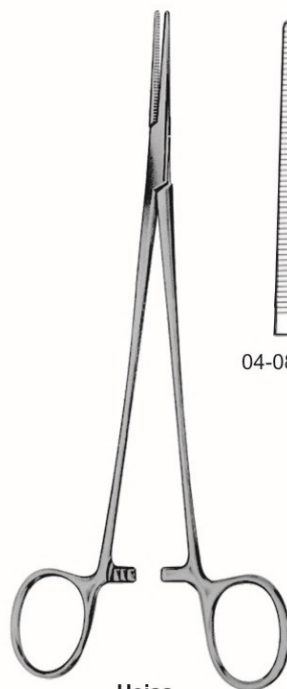

**Heiss**  
20cm/8"

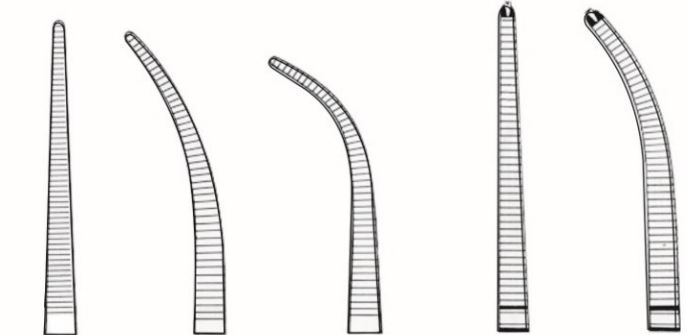

04-0875-20

04-0876-20

04-0877-20

04-0878-20

04-0879-20

## General Instruments

Dissecting and Ligature Forceps  
Anatomische und Ligaturklemmen

Dissection et Pince Ligatures  
Pinzas de disección y ligadura



**Meeker**  
04-0880-27  
27 cm/10"



**Toennis**  
21 cm/8¼"  
26 cm/10¼"

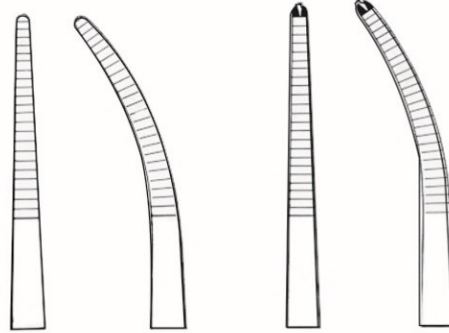

04-0881-21 04-0882-21 04-0883-21 04-0884-21  
04-0881-26 04-0882-26 04-0883-26 04-0884-26



**Lower**  
04-0885-18  
18 cm/7"



**Gemini**

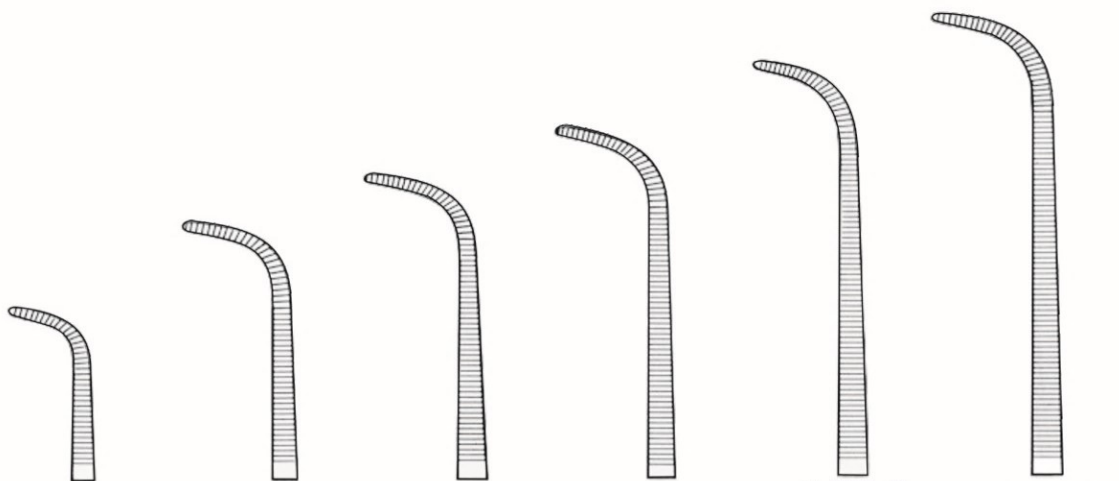

04-0886-13 04-0887-18 04-0888-20 04-0889-23 04-0890-25 04-0891-28  
13 cm/5" 18 cm/7" 20 cm/8" 23 cm/9" 25 cm/10" 28 cm/11½"

# General Instruments

Dissecting and Ligature Forceps  
Anatomische und Ligaturklemmen

Dissection et Pince Ligatures  
Pinzas de disección y ligadura

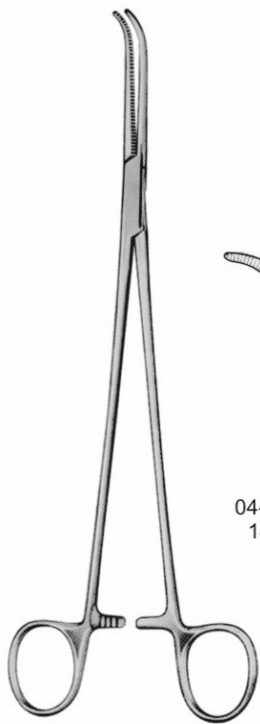

**Mini-Gemini**

04-0892-18  
18 cm/7"

04-0893-22  
22 cm/8 3/4"

04-0894-25  
25 cm/10"

04-0895-28  
28 cm/11"

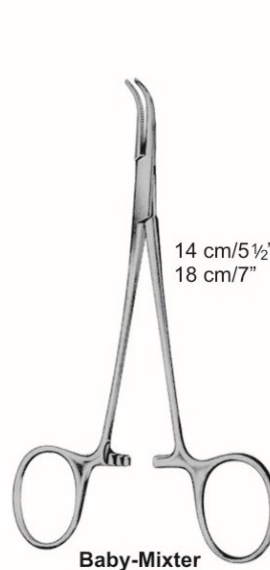

14 cm/5 1/2"  
18 cm/7"

04-0896-14  
04-0896-18

04-0897-14  
04-0897-18



**Mixer**

04-0898-15 15 cm/6"  
04-0898-19 19 cm/7 1/2"



**Mixer-O'Shaugnessy**

04-0899-15 15.5 cm/6"  
04-0899-19 19.0 cm/7 1/2"

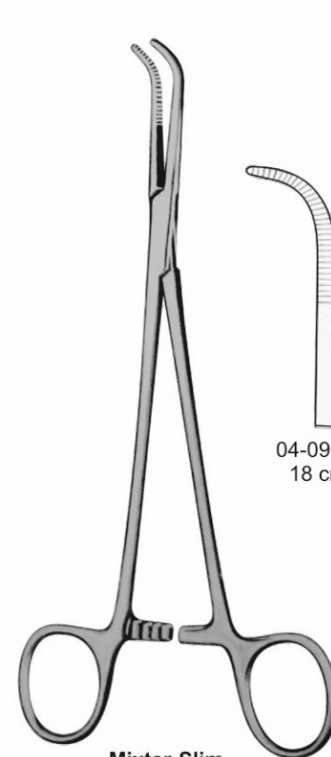

**Mixer-Slim**

04-0900-18  
18 cm/7"

04-0901-23  
23 cm/9"

## General Instruments

Dissecting, Ligature Forceps and Gall Stone Clamps

Anatomische, Faden-Pinzetten und Klemmen Gallenstein

Pinces à disséquer ligature et colliers en pierre Gall

Pinzas de disección, ligadura y abrazaderas de cálculos biliares



**Mixer**

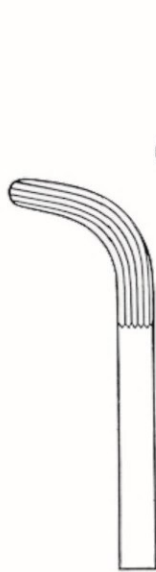

04-0902-22  
22 cm/8¾"

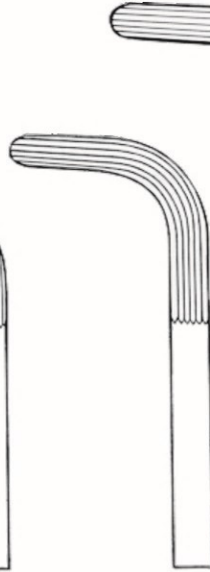

04-0903-25  
25 cm/10"

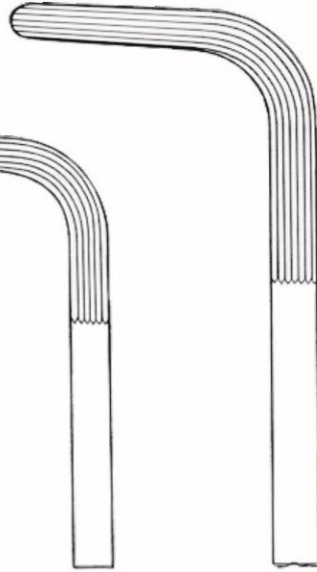

04-0904-28  
28 cm/11"



**Mixer**

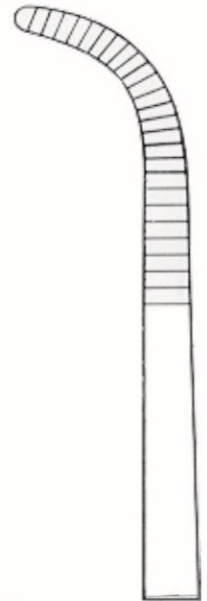

04-0905-22  
22 cm/8¾"



**Wickstroem**  
04-0906-20  
20 cm/8"

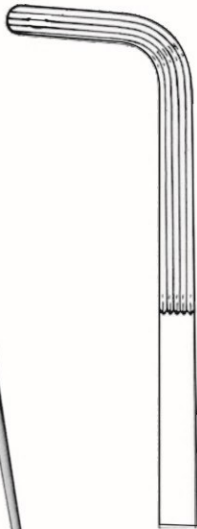

**Finocchietto**  
04-0907-24  
24 cm/9½"

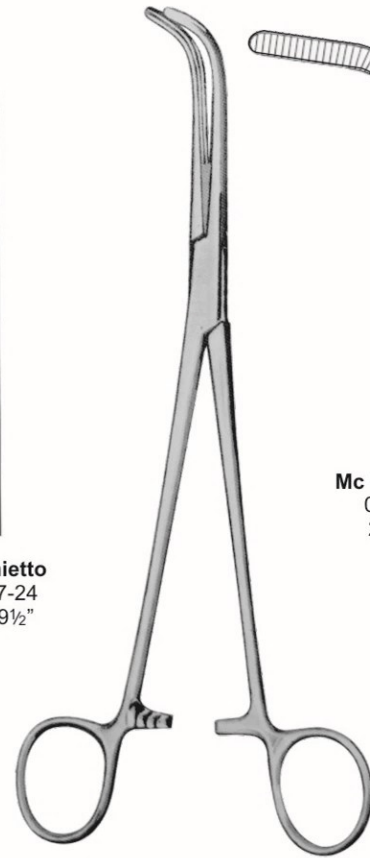

**Mc Quigg-Mixer**  
04-0908-22  
22 cm/8¾"

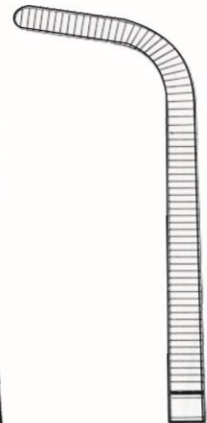

# General Instruments

Dissecting, Gall Duct Clamps and Hemostatic Forceps  
Zergliedern, Gallenwegefunktionsstörungen Klemmen und  
Arterienklemmen

Pinces à dissection Gall, de conduits et des pincés hémostatiques  
Dissección, Gall conducto abrazaderas y pinzas hemostáticas



**Lawrence**  
04-0909-27  
27.5 cm/10¾"



**Lahey (Sweet)**

04-0910-19  
19 cm/7½"

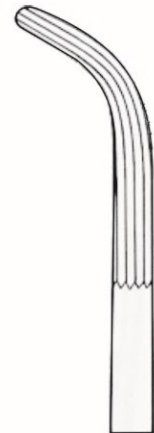

04-0911-23  
23 cm/9"



**Spencer-Wells**

04-0912-13 13 cm/5"  
04-0912-14 14 cm/5½"  
04-0912-15 15 cm/6"  
04-0912-18 18 cm/7"  
04-0912-20 20 cm/8"  
04-0912-23 23 cm/9"

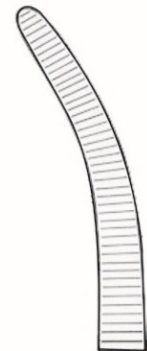

04-0913-13  
04-0913-14  
04-0913-15  
04-0913-18  
04-0913-20  
04-0913-23

## General Instruments

Parametrium and Hysterectomy Forceps  
Parametrium und Hysterektomie Zange

Pince paramètre et hystérectomie  
Parametrio y Histerectomía Pinzas



**Rogers**

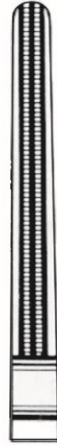

04-0914-22  
22.5 cm/9"  
04-0914-25  
25.0 cm/10"



04-0915-22  
22.0 cm/8<sup>3</sup>/<sub>4</sub>"  
04-0915-24  
24.5 cm/9<sup>3</sup>/<sub>4</sub>"

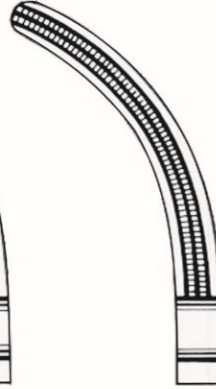

04-0916-21  
21.5 cm/8<sup>1</sup>/<sub>2</sub>"  
04-0916-24  
24.0 cm/9<sup>1</sup>/<sub>2</sub>"

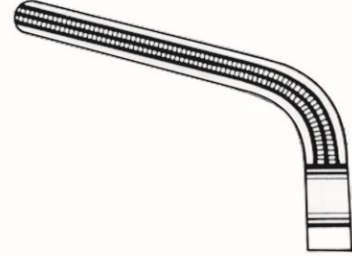

04-0917-20  
20.5 cm/8"  
04-0917-23  
23.5 cm/9"



**Heaney**

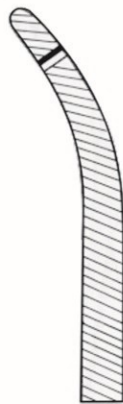

19.5 cm/7<sup>1</sup>/<sub>2</sub>" 04-0918-19  
21.5 cm/8<sup>1</sup>/<sub>4</sub>" 04-0918-21  
23.5 cm/9" 04-0918-23



04-0919-19  
04-0919-21  
04-0919-23

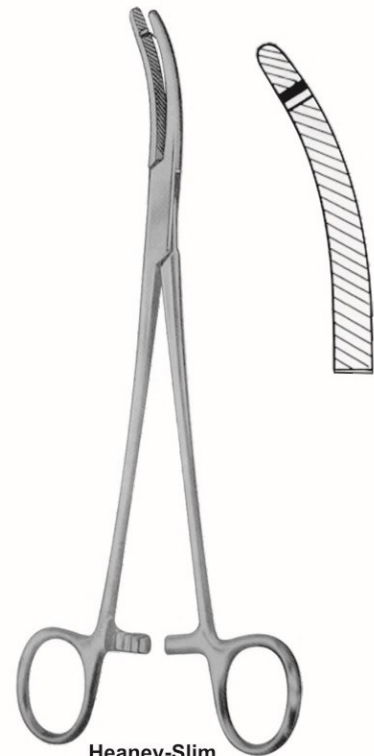

**Heaney-Slim**  
04-0920-21  
21 cm/8<sup>1</sup>/<sub>4</sub>"

# General Instruments

Hysterectomy Forceps  
Hysterectomy Zange

Zange Hysterectomy  
Hysterectomy Zange



**Ballentine**  
04-0921-21  
21cm/8¼"



**Heaney-Ballentine**  
04-0922-21  
21cm/8¼"



Tonsil Forceps  
Pince amygdales  
Pinzas de amígdalas

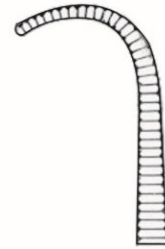
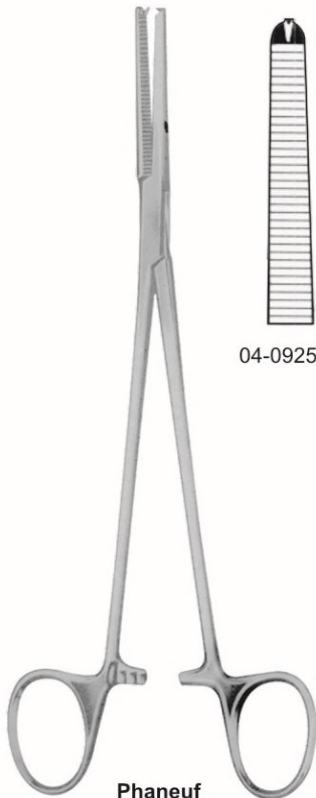

Fig. 1



Fig. 2

**Negus**  
04-0923-19 19cm/7½" 04-0924-19



**Phaneuf**  
21.5cm/8½"



04-0925-21

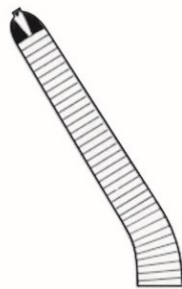

04-0926-21

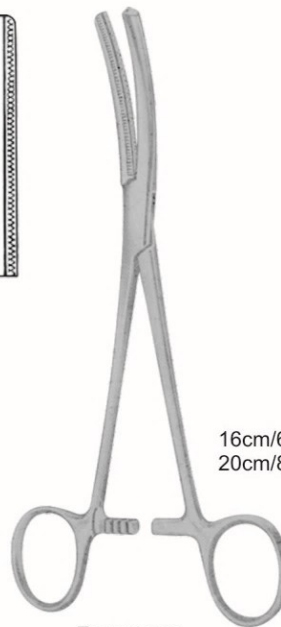
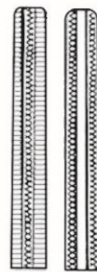

**Fergusson**

Haemorrhoidal Clamps  
Hämorrhoiden Clamps  
Pincés hémorroïdales  
Abrazaderas hemorroidales

|           |                                      |                                       |
|-----------|--------------------------------------|---------------------------------------|
|           | Straight<br>gerade<br>droit<br>recto | Curved<br>Gebogene<br>courbé<br>Curvo |
| 16cm/6 ¼" | 04-0927-16                           | 04-0928-16                            |
| 20cm/8"   | 04-0927-20                           | 04-0928-20                            |

# General Instruments

Clamp and Artery Forceps  
Clamp und Arterienklemmen

Pince de serrage et de l'artère  
Abrazadera y de la arteria Pinzas

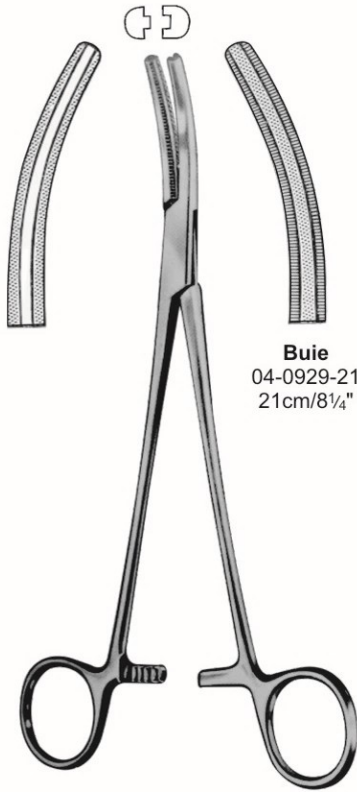

**Buie**  
04-0929-21  
21cm/8¼"

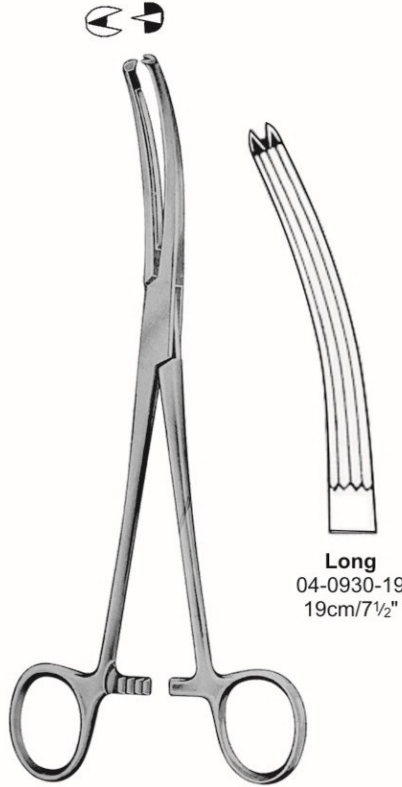

**Long**  
04-0930-19  
19cm/7½"

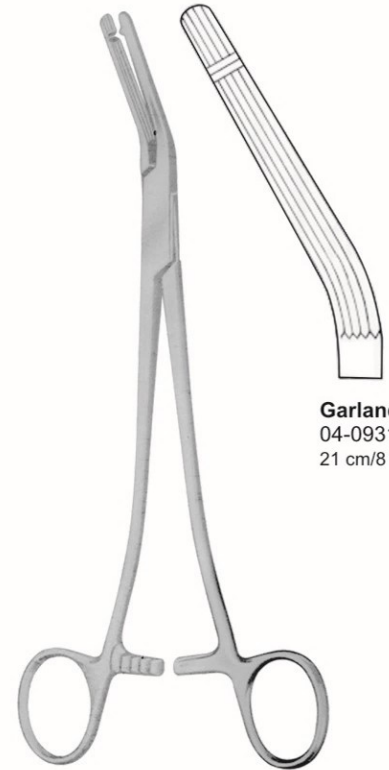

**Garland**  
04-0931-21  
21 cm/8¼"



Gall Duct Clamps  
Gall Lüftungsschellen  
Pincés pour conduits biliaires  
Conductos biliares Abrazaderas

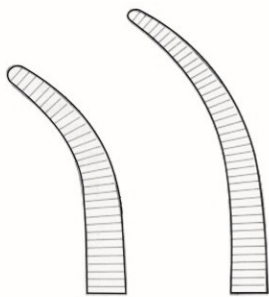

04-0932-23  
23cm/9"

04-0933-24  
24cm/9½"

**Moynihan**

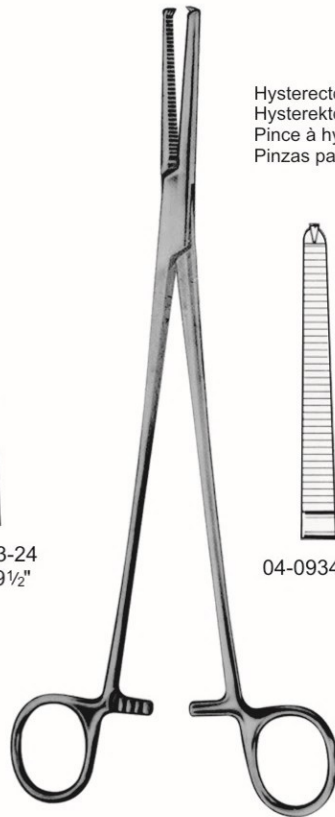

Hysterectomy Forceps  
Hysterektomie Zange  
Pince à hystérectomie  
Pinzas para histerectomía

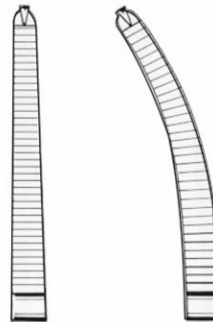

04-0934-23

04-0935-23

**Hozlbach**  
23.5cm/9¼"



Pressure Clamps  
Druckklemmen  
Pincés de pression  
Mordazas

**Zweifel**  
04-0936-17  
17.5cm/7"

# General Instruments

Hysterectomy Clamp and Vaginal Forceps  
 Hysterektomie Clamp und Vaginal Forceps

Clamp hystérectomie et Vaginal Forceps  
 La histerectomía y la abrazadera Vaginal Forceps

Scalp Flap Forceps  
 Pincas à rabat cuir chevelu  
 Pinzas del cuero cabelludo Flap

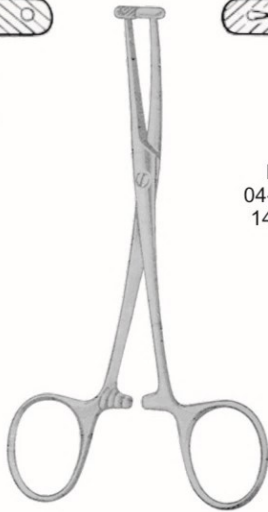

**Martel**  
 04-0938-14  
 14cm/5½"

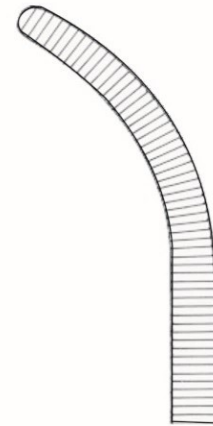

**Wertheim**  
 04-0939-25  
 25cm/10"

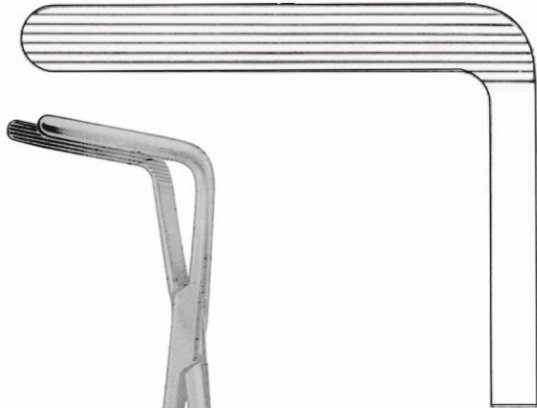

**Wertheim-Cullen**  
 04-0940-21  
 21.5cm/8½"

Extra Strong  
 extra Strong  
 extra Fuerte

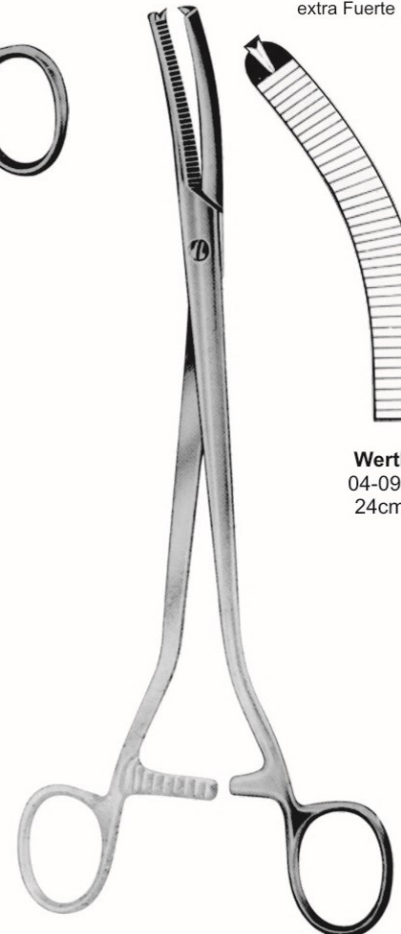
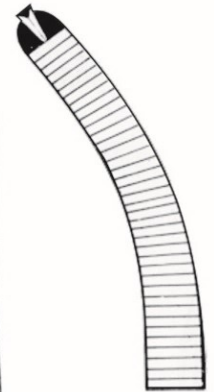

**Wertheim**  
 04-0941-24  
 24cm/9½"

## General Instruments

Hysterectomy Clamp and Vaginal Forceps  
Hysterektomie Clamp und Vaginal Forceps

Clamp hystérectomie et Vaginal Forceps  
La histerectomía y la abrazadera Vaginal Forceps

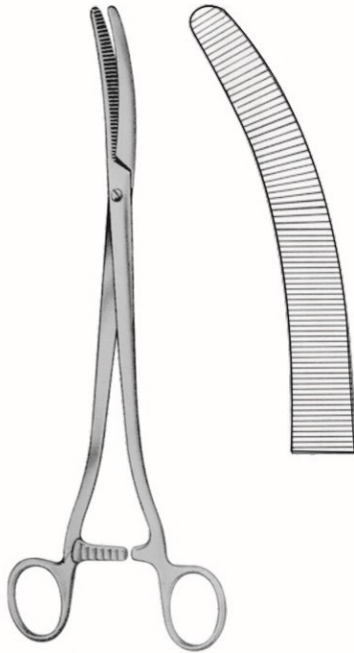

**Faure**  
04-0942-25  
25cm/10"



23cm/9"

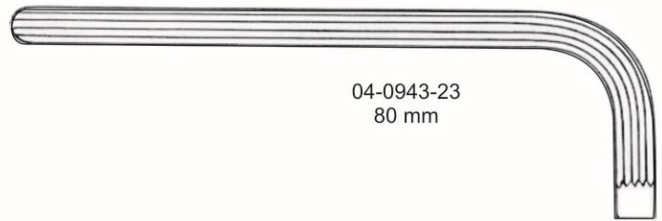

04-0943-23  
80 mm

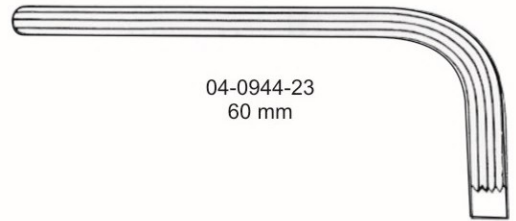

04-0944-23  
60 mm



**Wertheim**  
22cm/8¾"



04-0945-22  
Slightly Curved  
leicht gebogen  
légèrement incurvé  
Ligeramente curvada



04-0946-22  
More Curved  
mehr Curved  
plus courbé  
más curvo

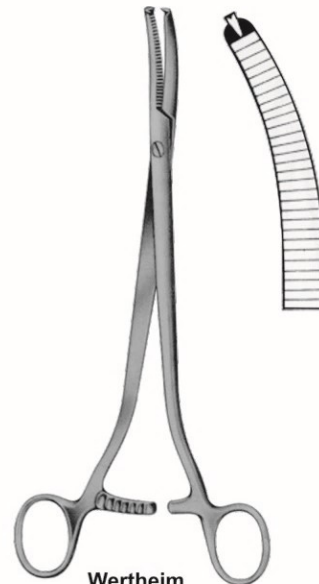

**Wertheim**  
04-0947-22  
22cm/8¾"

# General Instruments

Peritoneal Clamp and Hysterectomy Forceps  
 Peritoneal Clamp und Hysterektomie Zange

Pince Forceps péritonéale et hystérectomie  
 Abrazadera peritoneal y pinzas histerectomía

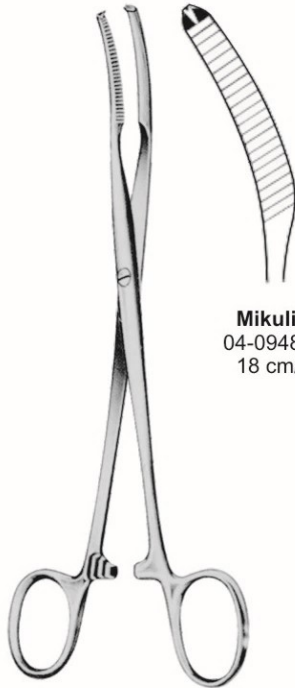

**Mikulicz**  
 04-0948-18  
 18 cm/7"

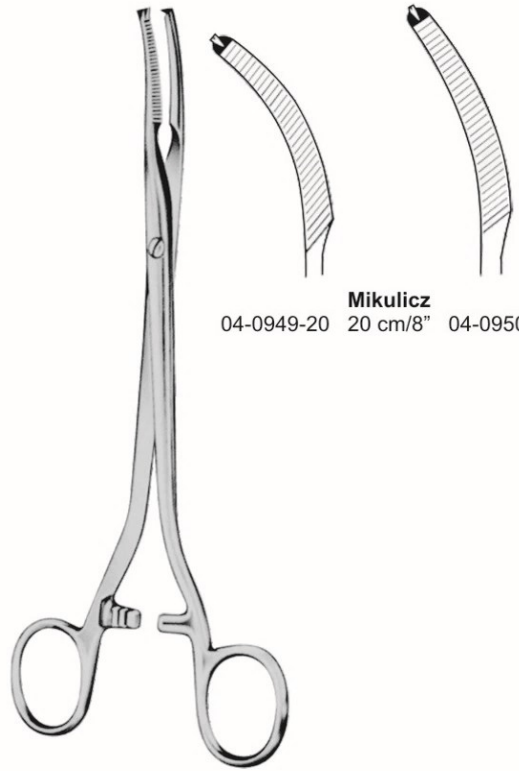

**Mikulicz**  
 04-0949-20 20 cm/8" 04-0950-20

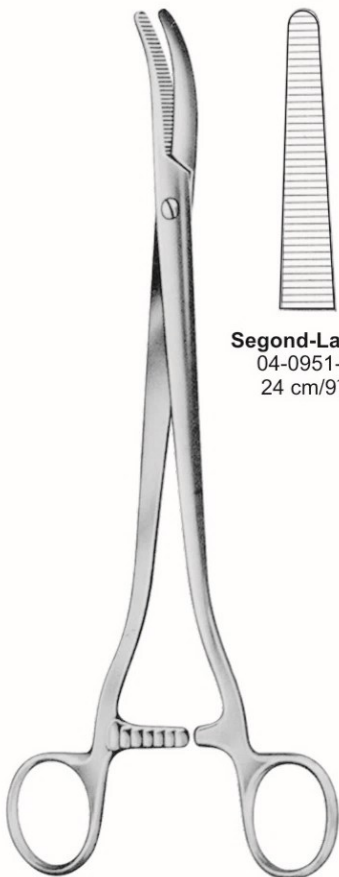

**Segond-Landau**  
 04-0951-24  
 24 cm/9½"

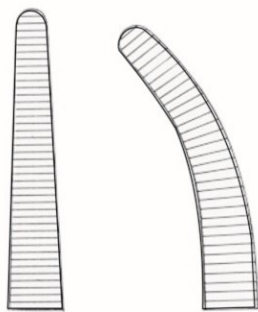

**Segond**  
 04-0952-24  
 24 cm/9½"

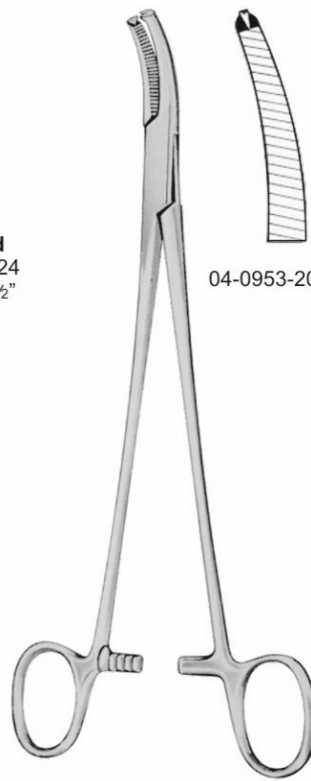

**Faure**  
 04-0953-20 20 cm/8" 04-0954-20

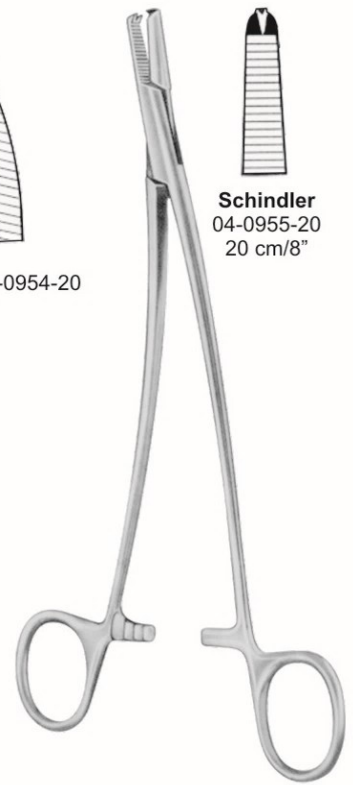
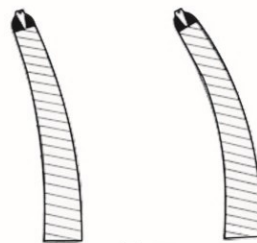

**Schindler**  
 04-0955-20  
 20 cm/8"



## General Instruments

Peritoneal Clamp Forceps  
Peritoneal Klammerzange

Pince de serrage péritonéale  
Pinzas peritoneal Clamp

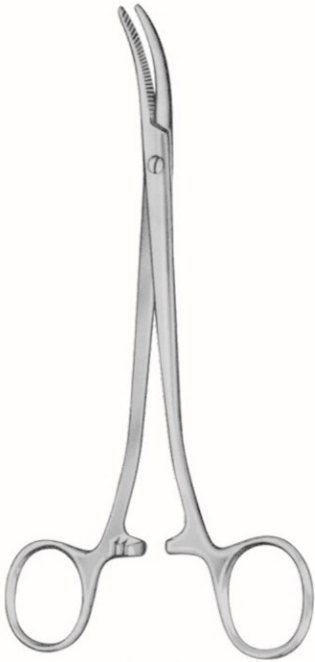

**Wertheim**  
04-0956-18  
18 cm/7"

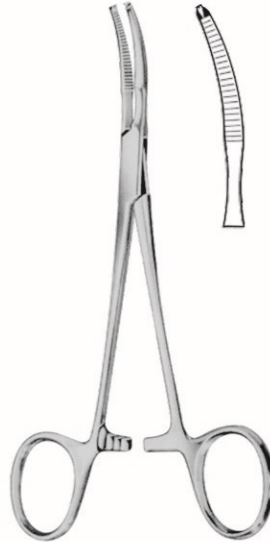

**Baby-Mikulicz**  
04-0957-14  
14 cm/5½"

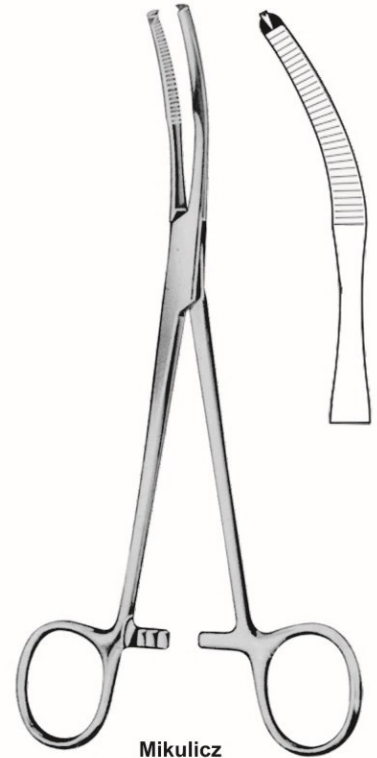

**Mikulicz**  
04-0958-18 18cm/7"  
04-0958-20 20cm/8"

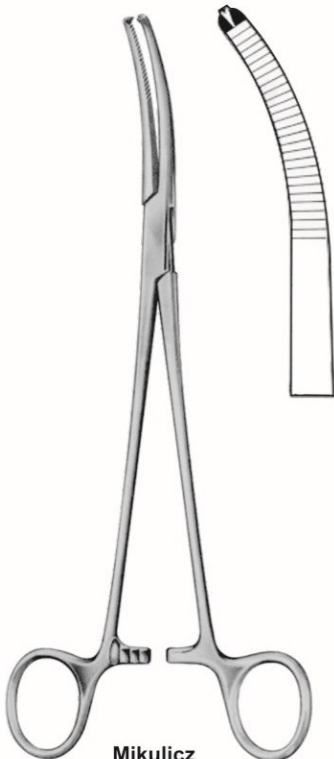

**Mikulicz**  
04-0959-20  
20 cm/8"

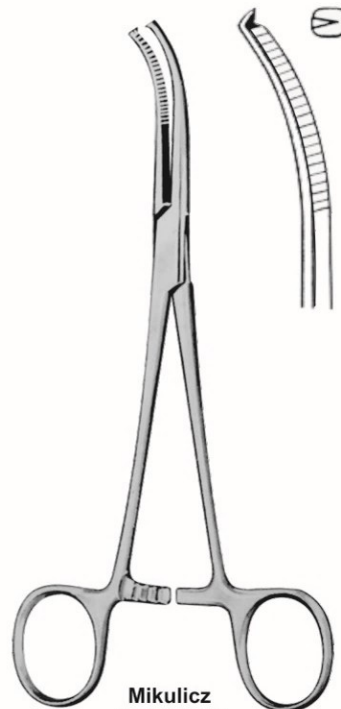

**Mikulicz**  
04-0960-18  
18.5 cm/7¼"

# General Instruments

Towel Forceps  
Tuchklemmen

Pince porte-serviettes  
Pinzas de toallas



**Schadel**  
04-0961-09 9 cm/3½"



**Jones**  
04-0962-05 5 cm/2"  
04-0962-09 9 cm/3½"



**Engl-Modell**  
04-0963-09 9 cm/3½"



**Backhaus**  
04-0964-09 9 cm/3½"  
04-0964-11 11 cm/4½"  
04-0964-13 13 cm/5"  
04-0964-15 15 cm/6"

With clip for Tubing or Cable  
Mit Clip für Schläuche oder Kabel  
Avec clip pour tube ou câble  
Con clip para tubos o cables



04-0965-11 11 cm/4½"  
04-0965-13 13 cm/5"



**Peers-Bertram**  
04-0966-14 14 cm/5½"

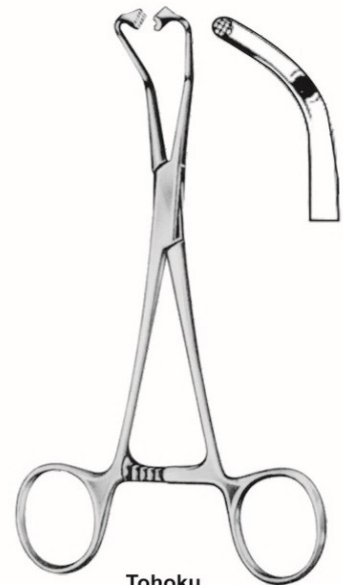

**Tohoku**  
04-0967-10 10 cm/4"  
04-0968-13 13 cm/5"



**Ball and socket**  
04-0969-10 10 cm/4"  
04-0969-13 13 cm/5¼"



**Roeder**  
04-0970-13 13 cm/5"  
04-0970-15 15 cm/6"



**Lorna**  
04-0971-10 10 cm/4"  
04-0971-13 13 cm/5"

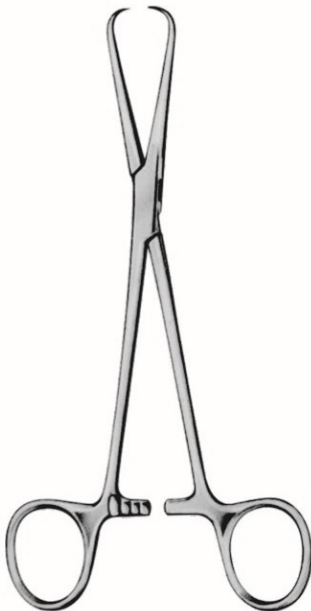

**Bernhard**  
04-0972-16 16.5 cm/6½"



**Lane**  
04-0973-13 13cm/5"  
04-0973-15 15cm/6"  
04-0973-18 18cm/7"  
04-0973-20 20cm/8"  
20 cm/8"



**Doyen**  
04-0974-18  
18 cm/7"

# General Instruments

Tubing Forceps  
Schläuche Pinzetten

Pince tubes  
Pinzas de tubo

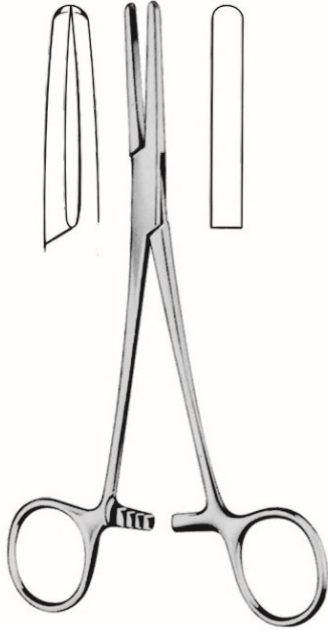

04-0975-14 14 cm/5 1/2"  
04-0975-15 15 cm/6"  
04-0975-18 18 cm/7"  
04-0975-20 20 cm/8"



04-0976-14  
14 cm/5 1/2"



04-0977-16 16.5 cm/6 1/2"  
04-0977-18 18.0 cm/7"

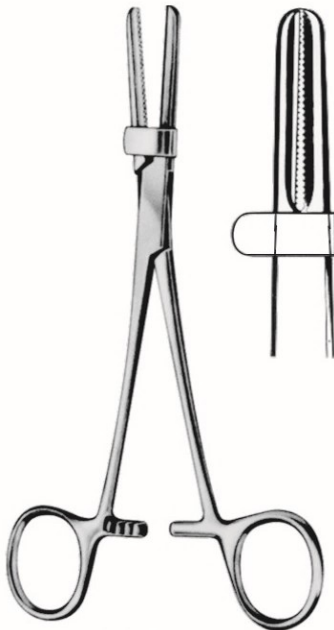

04-0978-15 15 cm/6"  
04-0978-18 18 cm/7"  
04-0978-20 20 cm/8"



### Mohr

04-0979-50 50 mm  
04-0979-60 60 mm  
04-0979-70 70 mm  
04-0979-80 80 mm

Sizes  
mm  
13  
17  
20  
25  
30

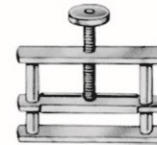

### Hoffmann

04-0980-13  
04-0980-17  
04-0980-20  
04-0980-25  
04-0980-30

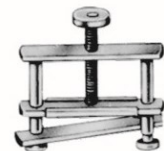

### Hoffmann

04-0981-13  
04-0981-17  
04-0981-20  
04-0981-25  
04-0981-30

## General Instruments

Cotton Swab Polypus and Dressing Forceps  
Wattestabchen und Tupfer-Kornzange

Coton-tige Polypus et pinces a pansement  
Esponja de algodon Polipos y pinzas Dressing

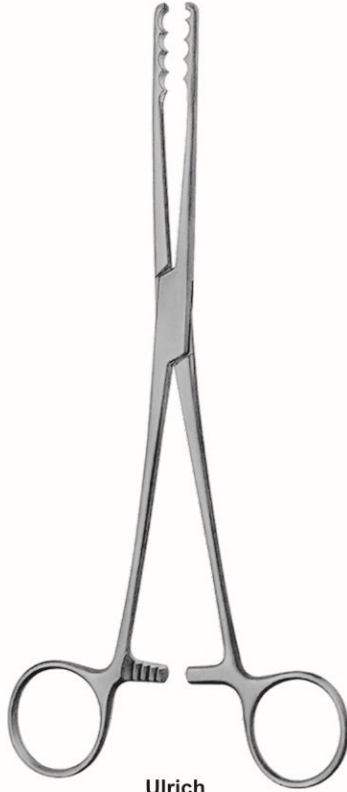

**Ulrich**

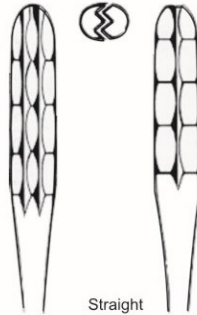

Straight  
gerade  
droit  
recto

05-0982-22  
05-0982-25  
05-0982-27

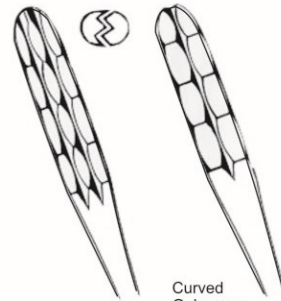

Curved  
Gebogene  
courbe  
Curvo

22 cm/8<sup>3</sup>/<sub>4</sub>"  
25 cm/10"  
27 cm/10<sup>1</sup>/<sub>2</sub>"

05-0983-22  
05-0983-25  
05-0983-27



**Lister**

05-0984-13 13 cm/5"  
05-0984-15 15 cm/6"  
05-0984-18 18 cm/7"



05-0985-13  
05-0985-15  
05-0985-18

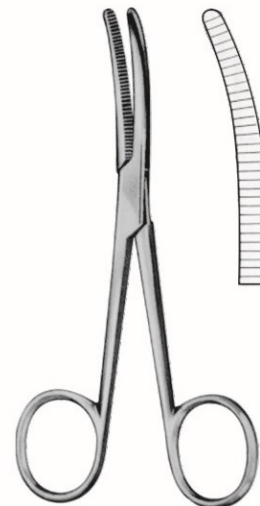

**Bryant**

05-0986-13  
13 cm/5"

# General Instruments

Polypus and Dressing Forceps  
Tupfer und Pinzette

Polypus et pincés à pansement  
Pólipos y pinzas de Vestir



**Gross-Maier**

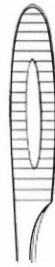

Straight  
gerade  
droit  
recto



Curved  
Gebogene  
courbé  
Curvo

With Ratchet  
mit Ratchet  
avec Ratchet  
Con Ratchet

05-0987-20  
05-0987-25

20 cm/8"  
25 cm/10"

05-0988-20  
05-0988-25

Without Ratchet  
ohne Ratchet  
sans cliquet  
Sin Ratchet

05-0989-20  
05-0989-25

20 cm/8"  
25 cm/10"

05-0990-20  
05-0990-25



**Pelkmann**  
25 cm/10"



05-0991-25



05-0992-25

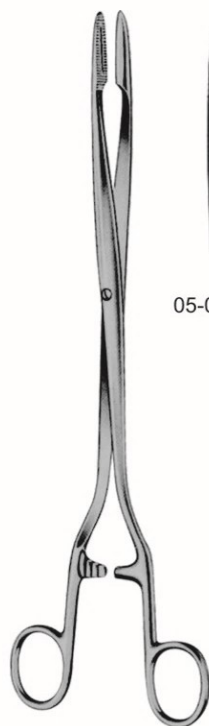

**Sims-Maier**  
28 cm/11"

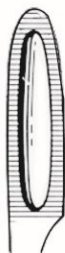

05-0993-28



05-0994-28



**Duplay**  
20 cm/8"



05-0995-20



05-0996-20

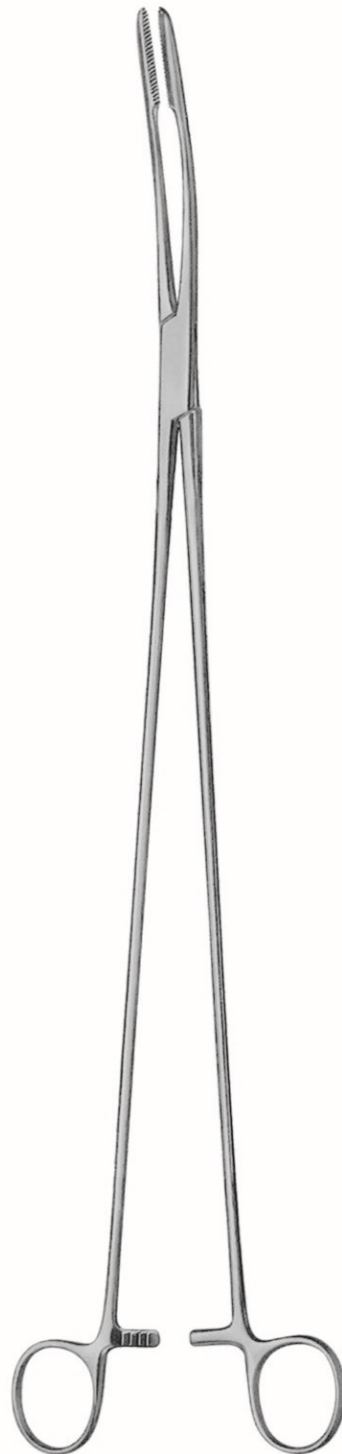

05-0997-40  
39.5 cm 15 1/2"

# General Instruments

Cotton Swab Forceps  
Tupferzangen

Coton-tige Forceps  
Esponja de algodón Pinzas

**Accu-Med**<sup>®</sup>  
Instrument Co.

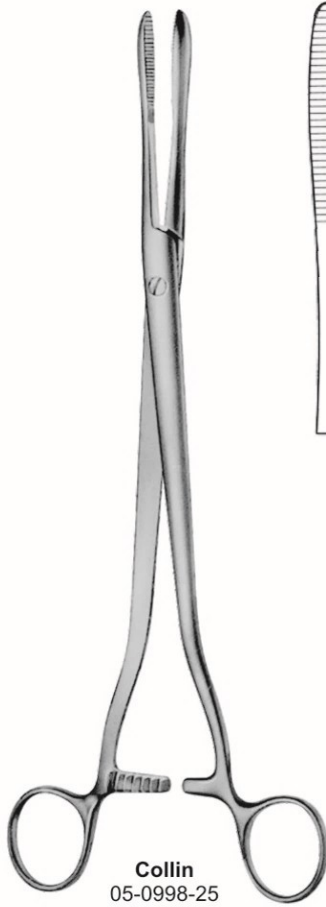

**Collin**  
05-0998-25  
25cm/10"  
05-0999-25 B/J  
25cm/10"



**Cheron**  
05-1000-25  
25cm/10"  
05-1001-25 B/J  
25cm/10"

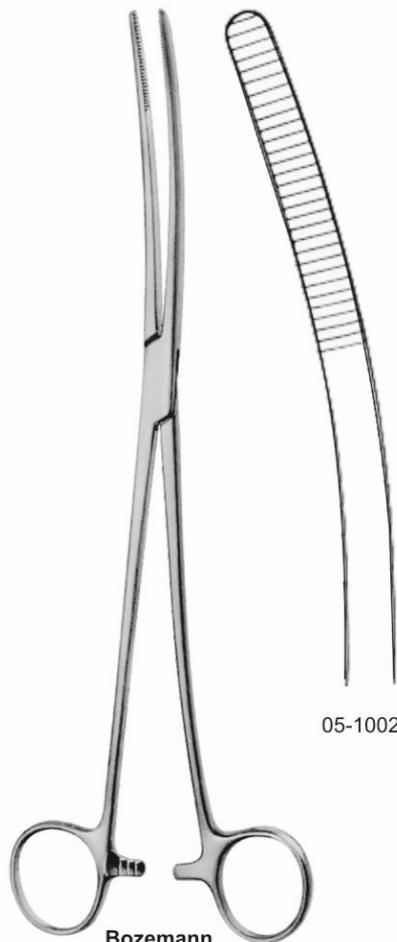

**Bozemann**  
26cm/10 1/4 "

05-1002-26

# General Instruments

Cotton Swab and Sponge Holding Forceps  
Wattestäbchen und Sponge Haltezange

Coton-tige, éponge Davier  
Hisopo de algodón y esponja Pinzas

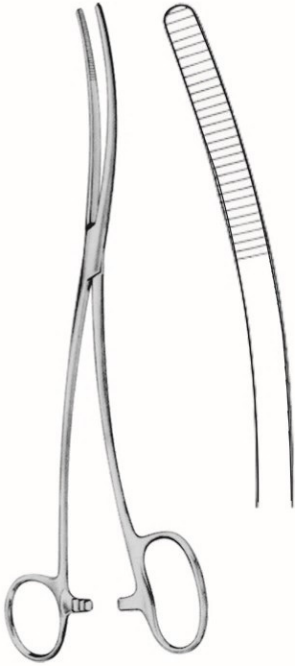

**Bozemann-Douglas**  
05-1003-26  
26cm/10¼"



**Foerster**

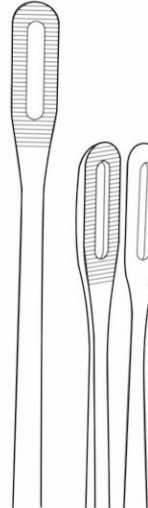

05-1004-25  
25 cm/9¾"

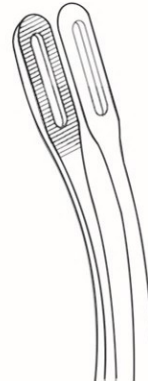

05-1005-25  
24.5 cm/9¾"

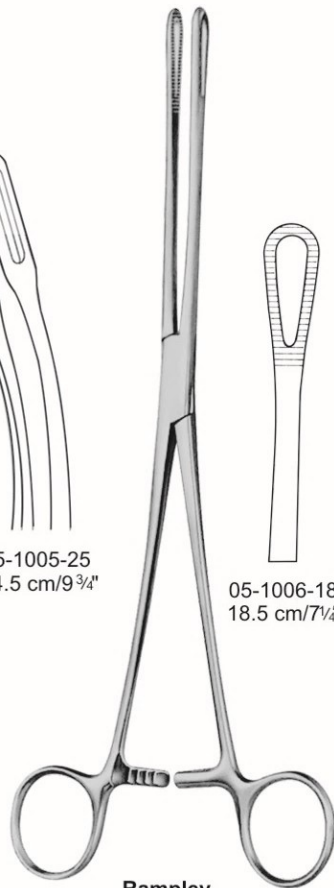

**Rampley**



05-1006-18  
18.5 cm/7¼"



05-1007-24  
24.5 cm/9¾"



**Foerster**



18 cm/7"  
20 cm/8"  
24 cm/9½"  
25 cm/10"

05-1008-18  
05-1008-20  
05-1008-24  
05-1008-25

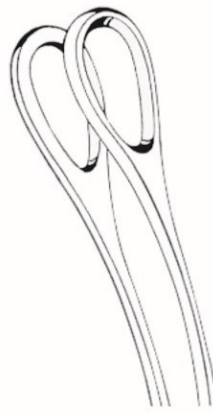

05-1009-18  
05-1009-20  
05-1009-24  
05-1009-25

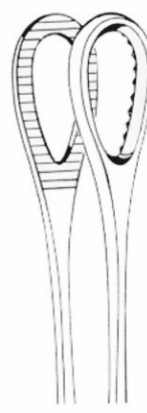

05-1010-18  
05-1010-20  
05-1010-24  
05-1010-25

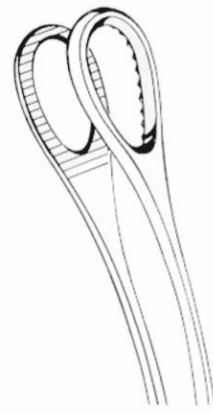

05-1011-18  
05-1011-20  
05-1011-24  
05-1011-25

# General Instruments

Bulldog Forceps  
Bulldog Zange

Bulldog Pincers  
Pinzas Bulldog



**Schwartz**  
05-1012-19  
19cm/7½"



05-1013-01



05-1014-02



05-1015-03

Applying Forceps  
Anlegezangen  
L'application de forceps  
La aplicación de fórceps



05-1016-23  
23cm/7"

## Atrauma



**Diethrich**

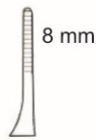

05-1017-08

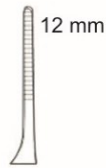

05-1017-12



05-1017-20



05-1019-10



05-1019-14



05-1019-20



05-1018-08

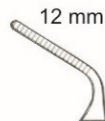

05-1018-12

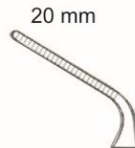

05-1018-20



05-1020-10



05-1020-14



05-1020-20