

General Instruments

Abdominal Retractors
Bauchdeckenhalter

Rétracteurs abdominale
Los retractoros abdominales



06-1366-19
19 cm/7½"

06-1367-10
Foldable frame
Faltrahmen
cadre pliant
marco plegable

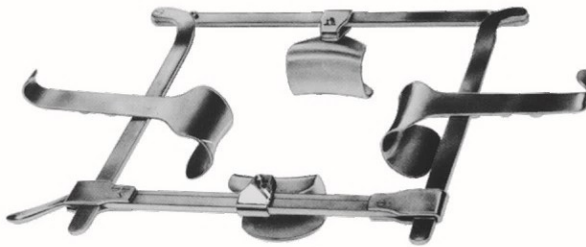

06-1367-01 38x60 mm
06-1367-02 45x80 mm

Franz

Complete with 4 valves
Komplett mit 4 Ventilen
Fourni avec 4 soupapes
Completa con 4 válvulas
06-1367-40

Complete with 8 valves
Komplett mit 8 Ventilen
Fourni avec 8 soupapes
Completa con 8 válvulas
06-1367-80

06-1367-03 50x65 mm
06-1367-04 60x85 mm

With
con

06-1367-10	1x
06-1367-01	2x
06-1367-03	2x

With
con

06-1367-10	1x
06-1367-01	2x
06-1367-02	2x
06-1367-03	2x
06-1367-04	2x

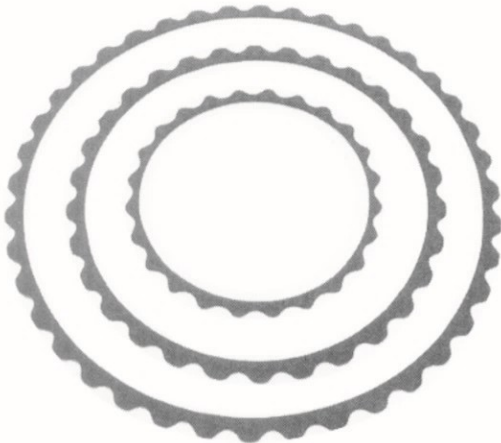

06-1368-00 Complete Set

Turner Warwick

- 1x 06-1368-18 18cm/7" Round
- 1x 06-1368-23 23cm/9" Round
- 1x 06-1368-30 30cm/12" Round
- 1x 06-1368-45 45cm/18" Oval
33cm/13"

Copper Blade



06-1368-01
19 x 76 mm

368-02
89 mm

}
im

2x 06-1368-04
57 x 114 mm

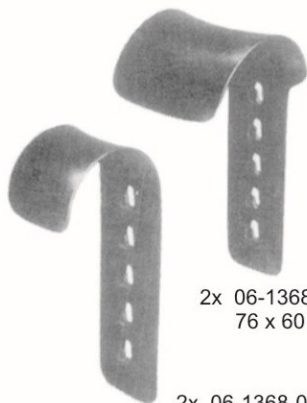

2x 06-1368-05
76 x 60 mm

2x 06-1368-06
51 x 38 mm



2x 06-1368-07
89 x 60 mm

2x 06-1368-08
114 x 60 mm

General Instruments

Wound and Nerve Hooks
Wund-und Nerven-Hooks

Crochets des plaies et du nerf
De la herida y los nervios Ganchos



Sharp
scharf
net
agudo
06-1025-01

blunt
stumpf
émousser
embotar
06-1025-02

Miller
13.5cm/5¼"



Crile
06-1026-20
20cm/8"



Cushing



Fig. 1

19cm/7 ½"
28cm/11"

06-1027-19
06-1027-28



Fig. 2

06-1028-19
06-1028-28



Kilner
06-1029-15
15cm/6"



Fig.1

Gillies
06-103018
18cm/7"



Fig.2

Gillies
06-1031-18
18cm/7"



Sharp
scharf
net
agudo

Frazier
06-1032-13 13cm/5"
06-1032-18 18cm/7"

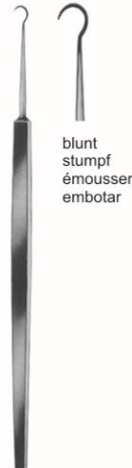

blunt
stumpf
émousser
embotar

06-1033-13
06-1033-18

General Instruments

Wound and Nerve Hooks
Wund-und Nerven-Hooks

Crochets des plaies et du nerf
De la herida y los nervios Ganchos

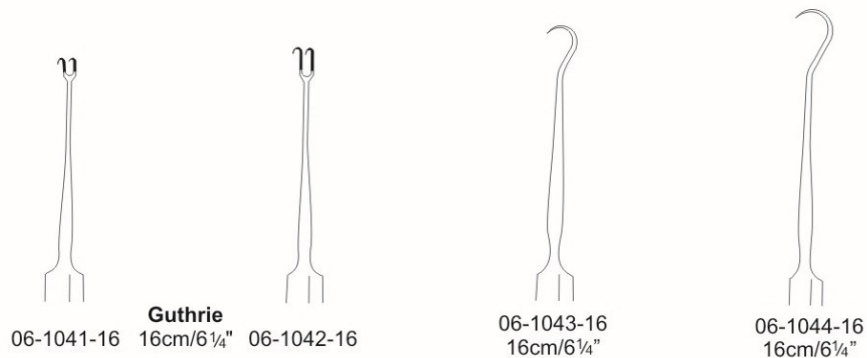
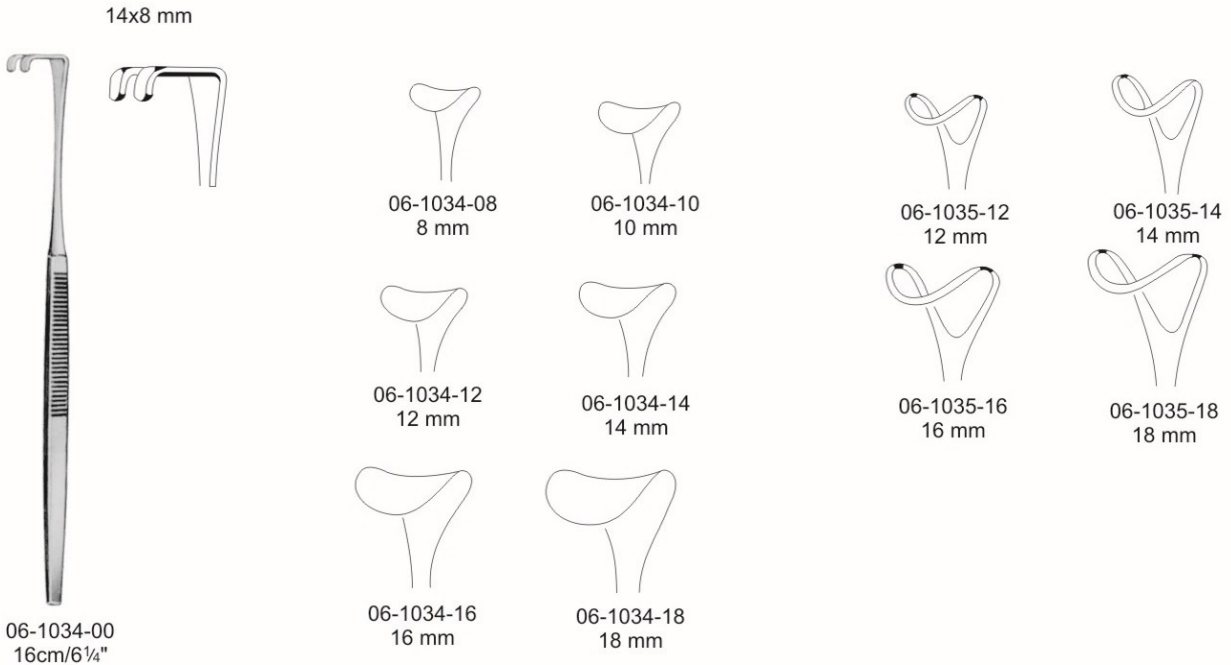

General Instruments

Wound and Trachea Retractors
Wund- und Luftröhre Retraktoren

Rétracteurs plaies et de la trachée
Heridas y tráquea Retractores

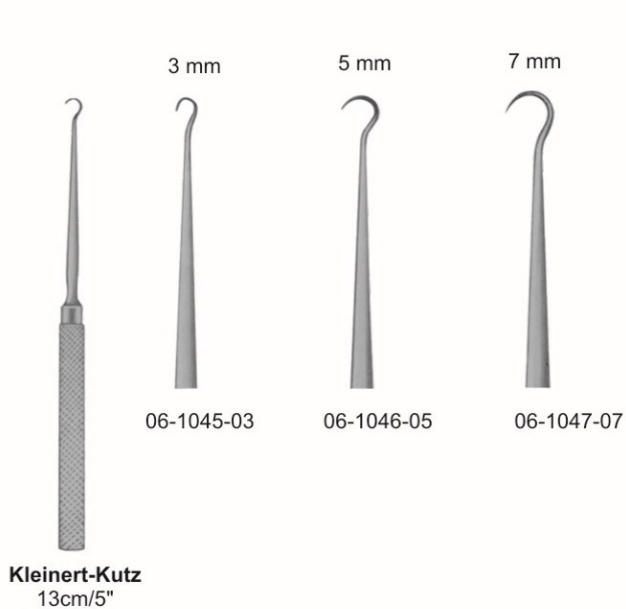

General Instruments

Retractors
Retraktoren

Rétracteurs
Retractoros

Malleable
formbar
malléable
maleable

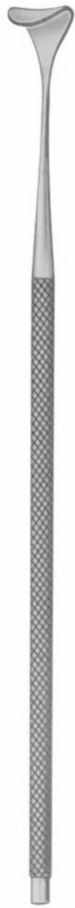

Gil-Vernet
24cm/9½"

8 mm 06-1053-08	06-1054-08
11 mm 06-1053-11	06-1054-11
15 mm 06-1053-15	06-1054-15
17 mm 06-1053-17	06-1054-17
20 mm 06-1053-20	06-1054-20
23 mm 06-1053-23	06-1054-23

Malleable
formbar
malléable
maleable



24cm/9½"

12x14 mm



Little
06-1055-20
20cm/8"



Love-(Morse)
25cm/10"

10 mm 06-1056-10
15 mm 06-1056-15
20 mm 06-1056-20
30 mm 06-1056-30
40 mm 06-1056-40
50 mm 06-1056-50

General Instruments

Wound and Trachea Retractors
Wund- und Luftröhre Retraktoren

Rétracteurs plaies et de la trachée
Heridas y tráquea Retractores

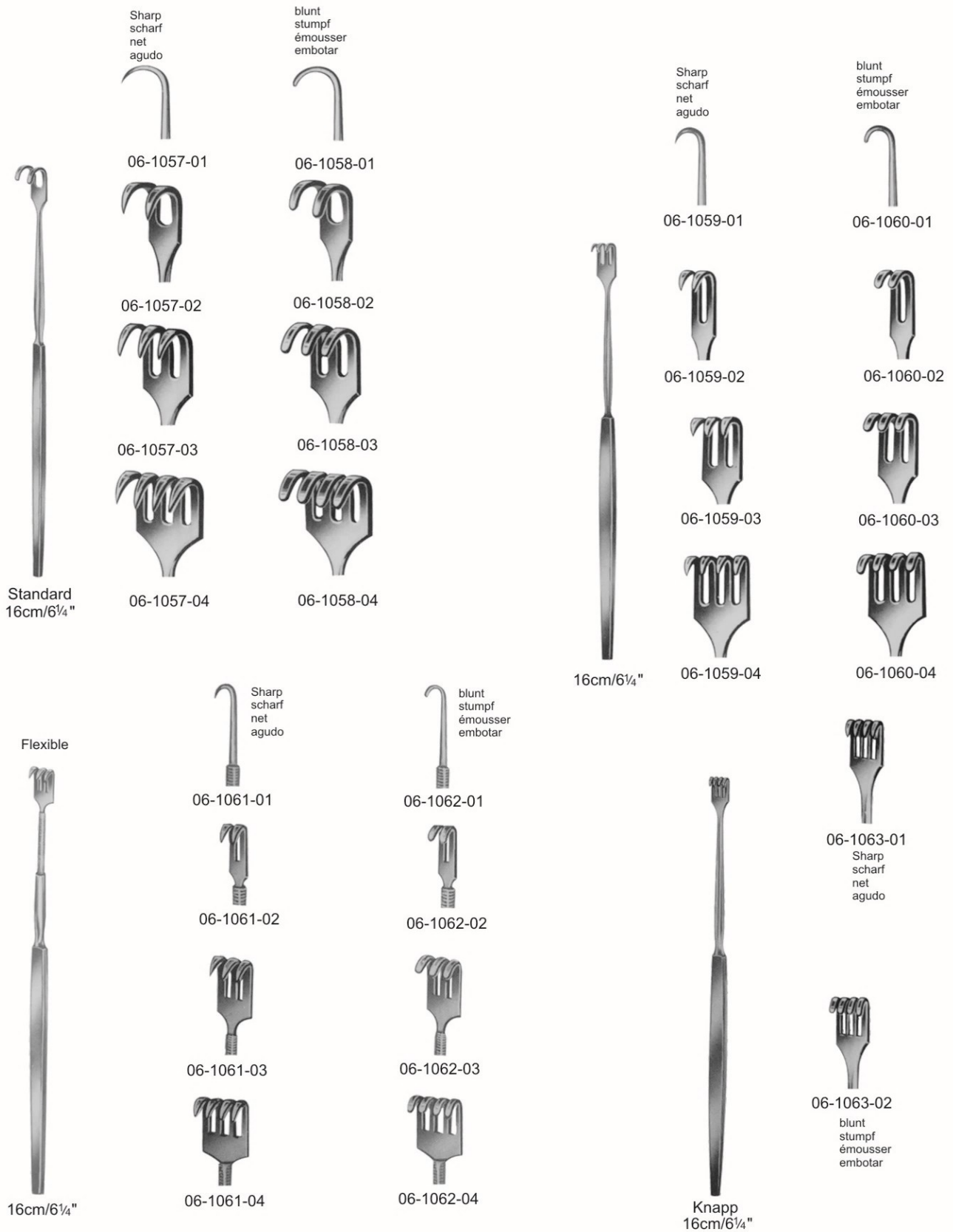

General Instruments

Trachea Retractors
Trachea Retraktoren

Rétracteurs trachée
tráquea Retractores



06-1064-13
13.5m/5¼"



Jackson
06-1065-13
13cm/5"



Bergmann
06-1066-14
14cm/5½"



Iterson
16cm/6¼"



06-1067-16



06-1067-16



Meyerding
18cm/7"



06-1068-18
18x7 mm



06-1071-18
16x5 mm



06-1069-18
7x4 mm



06-1072-18
10x3 mm



06-1070-18
7x4 mm



06-1073-18



Volkman
11.5cm/4½"



Sharp
scharf
net
agudo

06-1074-02



blunt
stumpf
émousser
embotar

06-1075-02



06-1074-03



06-1075-03



06-1074-04



06-1075-04



06-1074-06



06-1075-06

General Instruments

Wound and Vein Retractors
Wund-und Vein Retraktoren

Rétracteurs plaies et de la veine
Heridas y Vena Retractores



Cushing
06-1076-18
20cm/8"



06-1076-08
06-1076-10
06-1076-12
11-0158-14
06-1076-16

8 mm
10 mm
12 mm
14 mm
16 mm
18 mm

06-1077-08
06-1077-10
06-1077-12
06-1077-14
06-1077-16



Cushing
06-1077-18
24cm/9 1/2"



Desmarres
13cm/5"

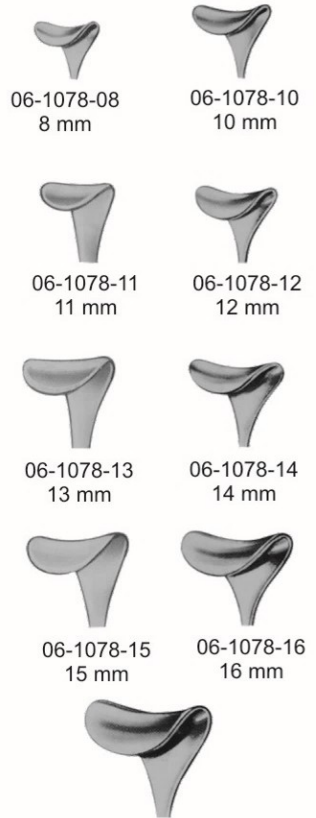

06-1078-08
06-1078-11
06-1078-13
06-1078-15

06-1078-10
06-1078-12
06-1078-14
06-1078-16

06-1078-18
18 mm



Konig
17cm/6 3/4"



06-1079-13
13x13 mm
06-1079-16
13x16 mm



Rose
06-1080-13
13cm/5"



Chile
06-1081-11
11cm/4 1/4"



Luer
06-1082-11
11.5cm/4 1/2"

General Instruments

Retractors
Retraktoren

Rétracteurs
Retradores

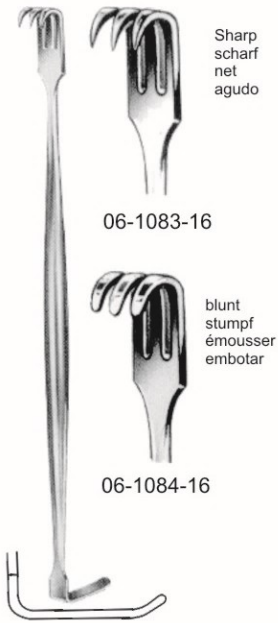

Senn-Miller
16cm/6¼"

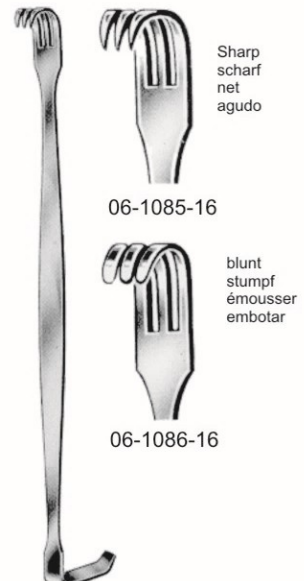

Baby-Senn-Miller
16cm/6¼"

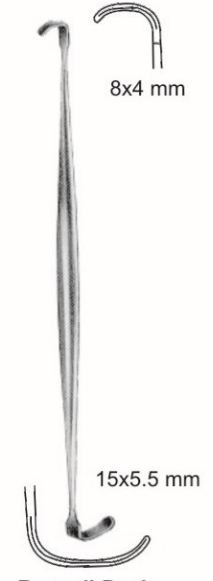

Rangell-Davis
06-1087-14
14cm/5½"



Senn-Green
15cm/6"



Langenbeck-Green
16cm/6¼"

General Instruments

Retractors and Tendon Sheath Hooks
Retraktoren und Sehnenscheide Haken

Rétracteurs et Crochets gaine du tendon
Los retractoros y ganchos la vaina del tendón



10x10 mm

Cushing-Kocher
06-1092-18
18cm/7"

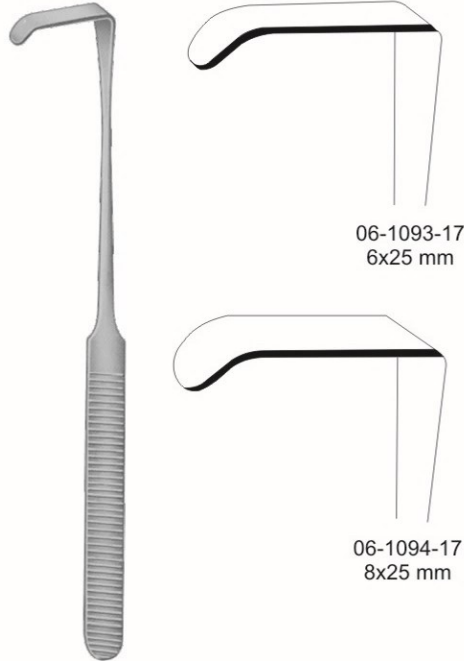

06-1093-17
6x25 mm

06-1094-17
8x25 mm

Langenbeck-Green
17cm/6¾"



Tendon Sheath Hook
Sehnenscheide Haken
Crochet gaine du tendon
Hook vaina del tendón

06-1095-19

06-1096-19

Strandell-Stille
19cm/7½"

Tendon Sheath Hook
Sehnenscheide Haken
Crochet gaine du tendon
Hook vaina del tendón

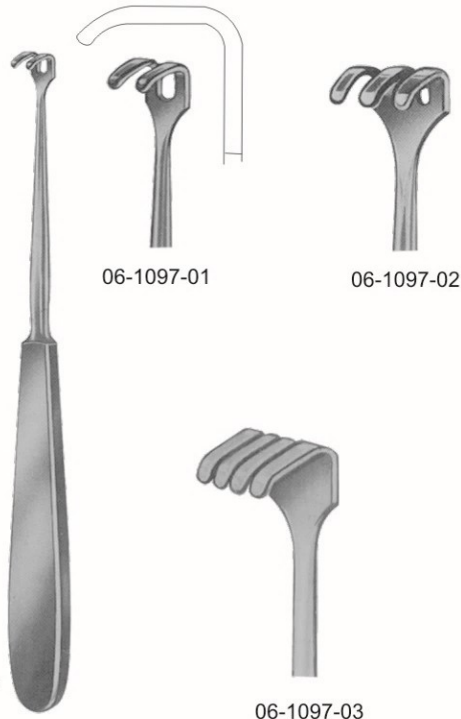

06-1097-01

06-1097-02

Klapp
17.5 cm/7"

06-1097-03

Decompression Hook
Decompression Haken
Crochet de décompression
descompresión Hook

Cushing
06-1098-20
20cm/8"

General Instruments

Retractors
Retraktoren

Rétracteurs
Retractoros



Collin-Hartmann

Set	06-1099-00
14 cm/5½"	06-1099-01
16 cm/6"	06-1099-02

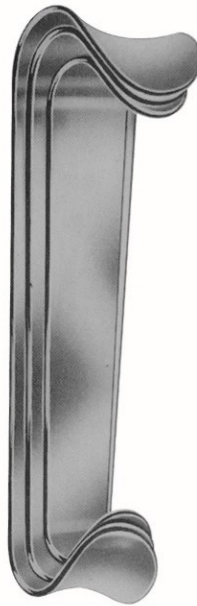

Roux

Set	06-1100-00
14 cm/5½" Fig. 1	06-1100-01
15 cm/6" Fig. 2	06-1100-02
17 cm/6¾" Fig. 3	06-1100-03



Baby-Roux
13 cm/5"

06-1101-13



Mini-Roux
14 cm/5½"

06-1102-14

37x40 mm

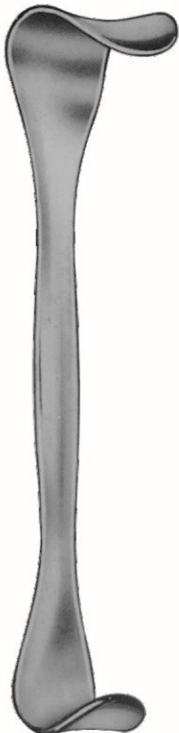

37x31 mm

Goelet
06-1103-19
19 cm/7½"



**Parker-Langenbeck
(US-Army)**
06-1104-21
21cm/8¼"

Set
setzen
fixer
establecer



Parker
06-1105-13
13.5 cm/5¼"

Set
setzen
fixer
establecer



Parker
06-1106-18
18 cm/7"

Set
setzen
fixer
establecer



Parker-Mott
06-1107-16
16 cm/6¼"

Set
setzen
fixer
establecer



Farabeuf
06-1108-12
12 cm/4 "

Set
setzen
fixer
establecer

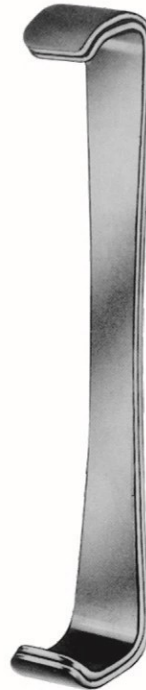

Farabeuf
06-1109-15
15 cm/6"

Set
setzen
fixer
establecer



Farabeuf
06-1110-01
8x10x100mm
06-1110-02
7x9x120mm
06-1110-03
11x14x120mm
06-1110-04
11x15x150mm
06-1110-05
21x15x150mm



Collin
06-1111-16
16.5 cm/6½"

Set
setzen
fixer
establecer



Mayo-Collin
06-1112-15
15 cm/6"

Set
setzen
fixer
establecer



Mathieu
06-1113-19
19 cm/7½"

Set
setzen
fixer
establecer

General Instruments

Retractors and Bone Retractors
Retraktoren und Bone Retraktoren

Rétracteurs et écarteurs à os
Separadores y Retractores hueso



Sharp
scharf
net
agudo

Volkman
06-1113-22
22 cm/8 3/4"



blunt
stumpf
émousser
embotar

Volkman
06-1114-22
22 cm/8 3/4"



Sharp
scharf
net
agudo

06-1115-23
23 cm/9"



blunt
stumpf
émousser
embotar

06-1116-23
23 cm/9"



Volkman
21,5cm/8 1/2"



Sharp
scharf
net
agudo

06-1117-01



06-1117-02



06-1117-03



06-1117-04



06-1117-06



06-1117-08

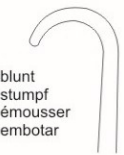

blunt
stumpf
émousser
embotar

06-1118-01



06-1118-02



06-1118-03



06-1118-04



06-1118-06



06-1118-08



semi-sharp
semi-scharfe
semi-forte
semi-fuerte

06-1119-01



06-1119-02



06-1119-03



06-1119-04



06-1119-06



06-1119-08

General Instruments

Retractors and Bone Retractors
Retraktoren und Bone Retraktoren

Rétracteurs et écarteurs à os
Separadores y Retractores hueso



Volkman
21 cm/8³/₄"

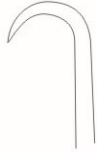

Sharp
scharf
net
agudo

06-1120-01



06-1120-02



06-1120-03



06-1120-04



06-1120-06

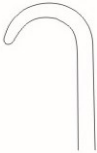

blunt
stumpf
émousser
embotar

06-1121-01



06-1121-02



06-1121-03



06-1121-04



06-1121-06



semi-sharp
semi-scharfe
semi-forte
semi-fuerte

06-1122-01



06-1122-02



06-1122-03



06-1122-04



06-1122-06



Sharp
scharf
net
agudo

06-1123-24
24.5 cm/9³/₄"



Sharp
scharf
net
agudo

Kocher
06-1124-21
21.5 cm/8¹/₂"



blunt
stumpf
émousser
embotar

Kocher
06-1125-21
21.5 cm/8¹/₂"



Sharp
scharf
net
agudo

Kocher
06-1126-21
21.5 cm/8¹/₂"



blunt
stumpf
émousser
embotar

Kocher
06-1127-21
21.5 cm/8¹/₂"

General Instruments

Retractors and Bone Retractors
Retraktoren und Bone Retraktoren

Rétracteurs et écarteurs à os
Separadores y Retractores hueso



Kocher
22 cm/8³/₄"

Sharp
scharf
net
agudo



06-1128-01



06-1128-02



06-1128-03



06-1128-04



06-1128-06



06-1128-08

blunt
stumpf
émousser
embotar



06-1129-01



06-1129-02



06-1129-03



06-1129-04



06-1129-06



06-1129-08

semi-sharp
semi-scharfe
semi-forte
semi-fuerte



06-1130-01



06-1130-02



06-1130-03



06-1130-04



06-1130-06



06-1130-08



Sharp
scharf
net
agudo

06-1131-20
20 cm/8"



blunt
stumpf
émousser
embotar

06-1132-20
20 cm/8"

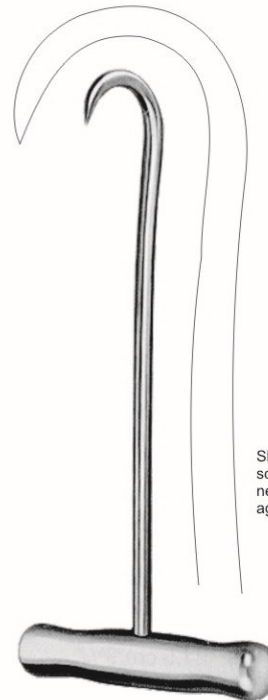

Sharp
scharf
net
agudo

06-1133-14
14 cm/5¹/₂"

General Instruments

Retractors
Retraktoren

Rétracteurs
Retractoros

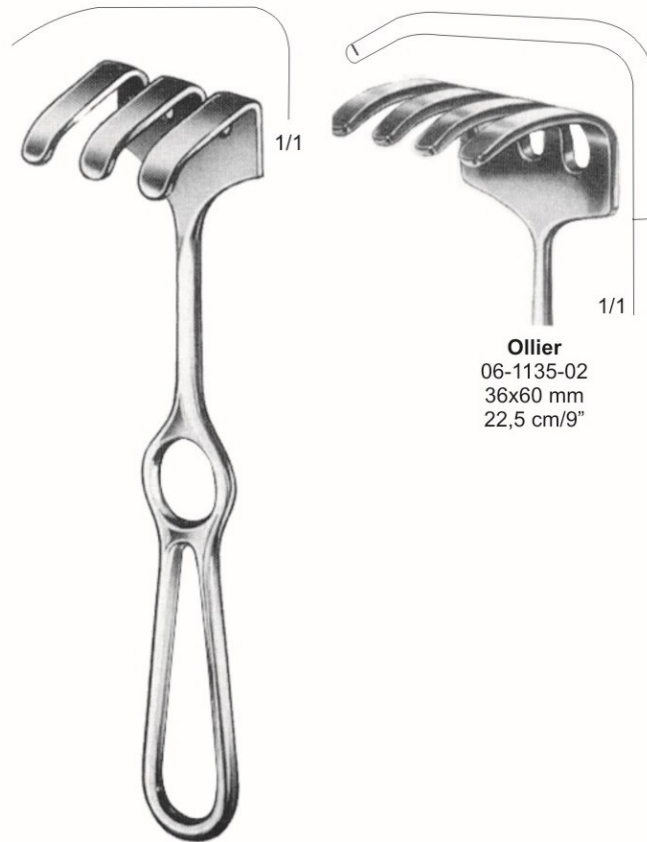

Ollier
06-1135-02
36x60 mm
22,5 cm/9"

Ollier
06-1134-01
36x30 mm
22,5 cm/9"



Murphy
19.5 cm/7 3/4"

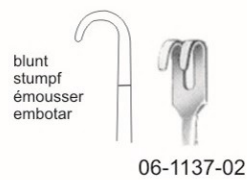

General Instruments

Retractors
Retraktoren

Rétracteurs
Retradores



33x20 mm

Wassmund
06-1138-20
20cm/8"



06-1139-02
40x50 mm

Israel
25cm/10"



06-1139-01
40x40 mm



06-1139-03
50x60 mm



06-1139-04
70x70 mm



46x55 mm

Koerte
23cm/9"

Vertical Handle
vertikale Griff
poignée verticale
asa vertical
06-1140-23



Koerte-Wagner
06-1141-28
28cm/11"



Koerte
23.5 cm/9¼"

Vertical Handle
vertikale Griff
poignée verticale
asa vertical

40x30 mm



blunt
stumpf
émousser
embotar
06-1143-23

Sharp
scharf
net
agudo
06-1142-23



06-1144-24
24cm/9½"

Vertical Handle
vertikale Griff
poignée verticale
asa vertical

50x25 mm



06-1145-25
25cm/10"

General Instruments

Retractors
Retraktoren

Rétracteurs
Retradores



Langenbeck

06-1146-01 22x6mm 21.5cm/8¼"
06-1146-02 44x13mm 21.5cm/8¼"
06-1146-03 64x25mm 21.5cm/8¼"



Langenbeck

06-1147-01
55x20 mm
06-1147-02
60x20 mm
06-1147-03
63x20 mm

21cm/8¼"



Langenbeck

06-1148-01
35x7 mm
06-1148-02
35x10 mm
06-1148-03
35x15 mm
06-1148-04
60x20 mm

21cm/8¼"



Lahey

06-1149-19
28x6 mm

19cm/7½"



22.5cm

Sauerbruch

06-1150-01 45x15 mm
06-1150-02 60x23 mm
06-1150-03 75x20 mm



Langenbeck

21cm/8¼"

06-1151-01 30x11 mm 11-0374-01
06-1151-02 30x14 mm 11-0374-02
06-1151-03 33x14 mm
06-1151-04 30x16 mm 11-0374-04
06-1151-05 40x11 mm 11-0374-05
06-1151-06 42x13 mm
06-1151-07 50x11 mm 11-0374-07



Langenbeck

22cm/8¾"

General Instruments

Retractors
Retraktoren

Rétracteurs
Retractoros

06-1152-01 40x10 mm
06-1152-02 40x15 mm
06-1152-03 40x20 mm



Kocher
22cm/8¾"

06-1153-01
19x12 mm
06-1153-02
21x15 mm



Kocher
19cm/7½"

06-1154-01 25x06 mm
06-1154-02 25x08 mm
06-1154-03 35x08 mm
06-1154-04 35x11 mm
06-1154-05 35x15 mm
06-1154-06 42x11 mm
06-1154-07 55x11 mm
06-1154-08 70x14 mm
06-1154-09 80x12 mm
06-1154-10 80x16 mm

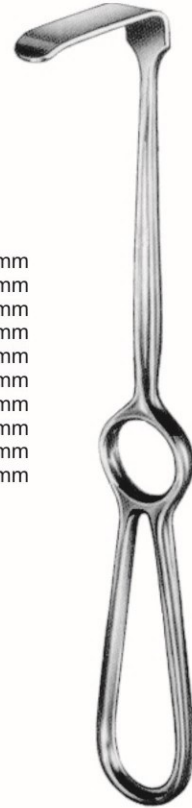

Kocher-Langenbeck
21.5cm/8½"



Czerny
06-1155-18
18 cm/7"



67x17cm

Casper
06-1156-21
21.5cm/8½"

General Instruments

Retractors
Retraktoren

Rétracteurs
Retradores



06-1157-03
67x25 mm



06-1157-01
22x15 mm



06-1157-04
100x35 mm

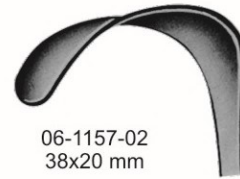

06-1157-02
38x20 mm



06-1158-01
40x18 mm
06-1158-02
60x20 mm
06-1158-03
60x25 mm
06-1158-04
75x30 mm
06-1158-05
75x40 mm

Kocher
23cm/9"

Kocher-Wagner
28cm/11"



06-1159-01
60x20 mm
06-1159-02
80x30 mm
06-1159-03
100x30 mm
06-1159-04
120x30 mm
06-1159-05
140x30 mm
06-1159-06
140x40 mm

Heesel
25cm/10"

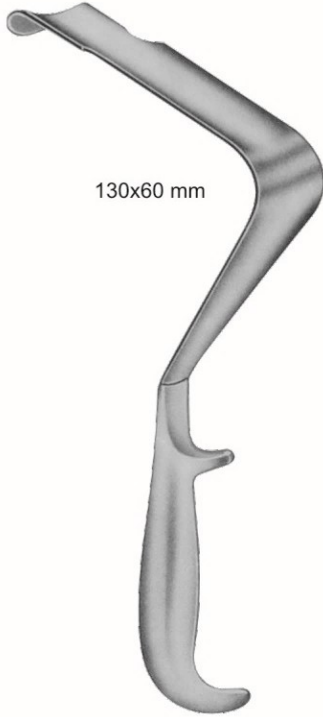

130x60 mm

St. Marks
06-1161-29
29cm/11½"

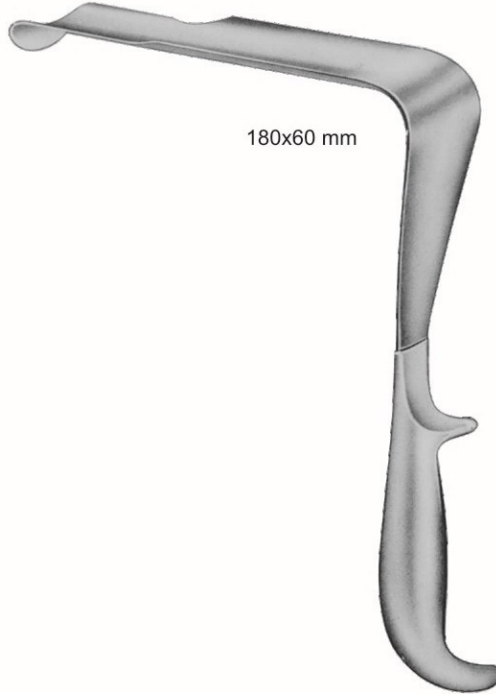

180x60 mm

St. Marks
06-1162-32
32.5cm/12¾"

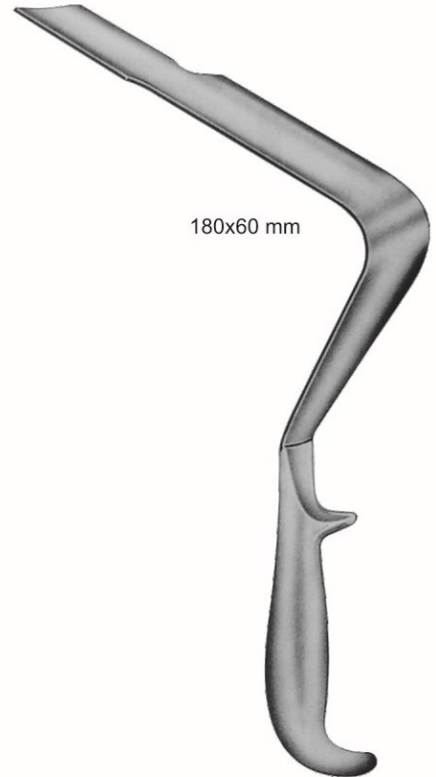

180x60 mm

St. Marks
06-1163-33
33cm/13"



06-1164-01
70x40 mm
06-1164-02
70x50 mm
06-1164-03
70x65 mm

Morris
21cm/8¼"



06-1165-01
32x50 mm/38x50mm
06-1165-02
45x50 mm/50x50mm
06-1165-03
65x50 mm/38x50mm

Morris
24cm/9½"

General Instruments

Retractors and Meniscus Retractors
Retraktoren und Meniskus Retraktoren

Rétracteurs Rétracteurs et méniscales
Separadores y Retractores de menisco



38x9 mm

Meniscus Retractors
Ecarteurs ménisque
Retradores de menisco

06-1166-21
21cm/8¼"



40x5 mm

Blount
06-1167-18
18cm/7"



Crawford
19cm/7½"

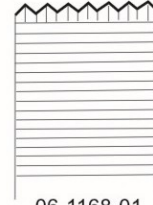

06-1168-01
15x15 mm

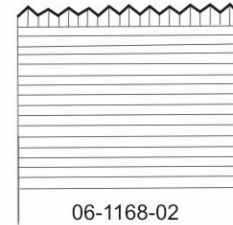

06-1168-02
15x23 mm



Green
06-1169-22
22cm/8½"



Middeldorpf

06-1170-01



14x17 mm
21.5cm/8½"

06-1171-01

06-1170-02



20x22 mm
22cm/8¾"

06-1171-02

06-1170-03



26x30 mm
23.5cm/9¼"

06-1171-03



Middeldorpf

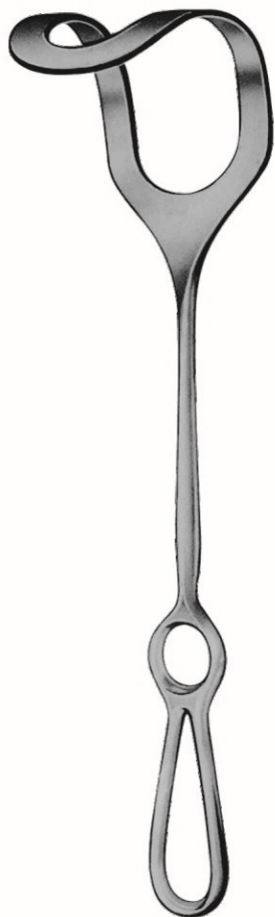

Middeldorp
25.5cm/10"

06-1172-01
45x45 mm
06-1172-02
45x50 mm
06-1172-03
55x70 mm



Richardson
26cm/10¼"



06-1173-01
28x20 mm

06-1173-02
36x28 mm

06-1173-03
44x38 mm

06-1173-04
52x22 mm

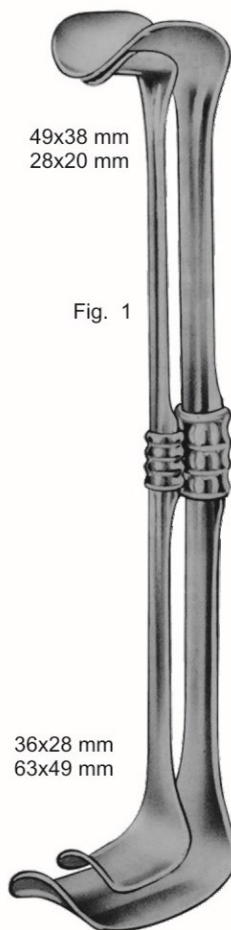

49x38 mm
28x20 mm

Fig. 1



Fig. 2

36x28 mm
63x49 mm

Richardson-Eastman

Set 06-1174-00
setzen
fixer
fixer
establecer

Fig. 1
26cm/10¼" 06-1174-01

Fig. 2
28cm/11" 06-1174-02

Kelly
26cm/10¼"

06-1175-01
40x50 mm
06-1175-02
50x65 mm
06-1175-03
65x75 mm
06-1175-04
75x90 mm

General Instruments

Retractors
Retraktoren

Rétracteurs
Retradores



General Instruments

Retractors
Retraktoren

Rétracteurs
Retractoros



06-1180-01
40x40 mm
06-1180-02
45x40 mm
06-1180-03
45x50 mm
06-1180-04
45x60 mm
06-1180-05
45x75 mm
06-1180-06
65x85 mm

Fritsch
24cm/9½"



50x85 mm

Doyen
06-1181-25
25cm/10"

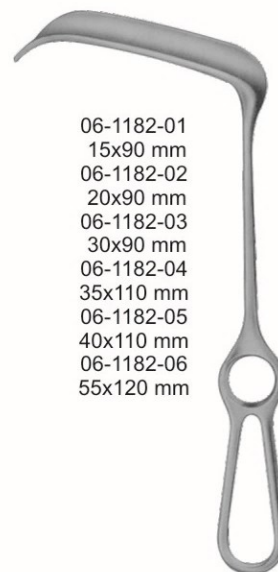

06-1182-01
15x90 mm
06-1182-02
20x90 mm
06-1182-03
30x90 mm
06-1182-04
35x110 mm
06-1182-05
40x110 mm
06-1182-06
55x120 mm

Doyen-Stille
24cm/9½"



70x25 mm

Kocher
06-1183-22
22.5cm/9"



06-1184-01
80x45 mm
06-1184-02
80x55 mm
06-1184-03
80x65 mm

Kocher
25cm/10"



64x60 mm

Tuffier
06-1185-23
23cm/9"

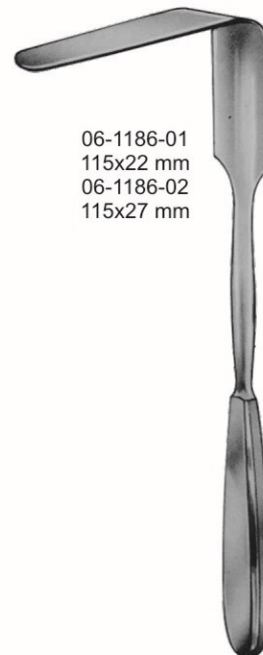

06-1186-01
115x22 mm
06-1186-02
115x27 mm

Simon
28cm/11"

General Instruments

Retractors and Liver Retractors
Retraktoren und Leber Retraktoren

Rétracteurs Rétracteurs et du foie
Separadores y Retractores hepáticos

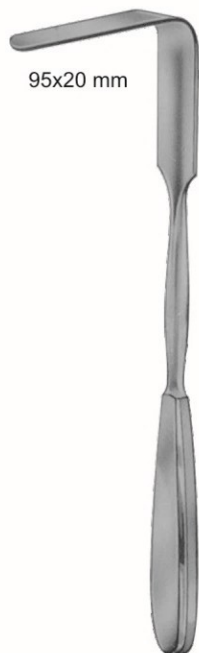

95x20 mm

Tuebingen
06-1187-28
28cm/11"

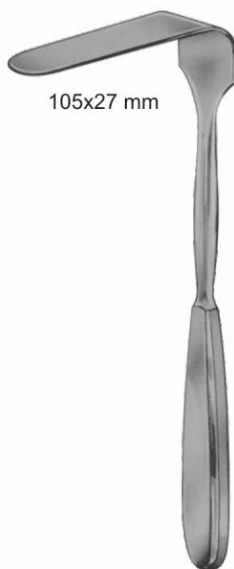

105x27 mm

Martin
06-1188-26
26cm/10¼"

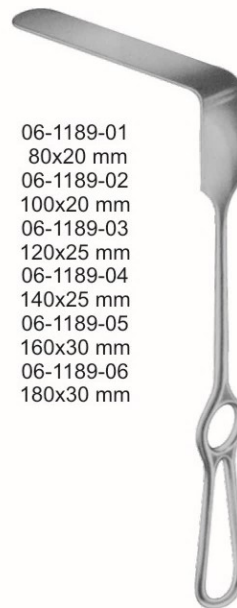

06-1189-01
80x20 mm
06-1189-02
100x20 mm
06-1189-03
120x25 mm
06-1189-04
140x25 mm
06-1189-05
160x30 mm
06-1189-06
180x30 mm

Brunner
25cm/10"



06-1190-01
80x20 mm
06-1190-02
100x20 mm
06-1190-03
120x25 mm
06-1190-04
140x25 mm
06-1190-05
160x30 mm
06-1190-06
180x30 mm

Brunner
25cm/10"



90x50 mm

06-1191-01
95x35 mm
06-1191-02
120x50 mm
06-1191-03
155x50 mm

Mikulicz
26cm/10¼"



90x50 mm

Mikulicz
06-1192-26
26cm/10¼"

General Instruments

Retractors
Retraktoren

Rétracteurs
Retradores



06-1193-01
160x38 mm
06-1193-02
160x57 mm
06-1193-01
190x38 mm
06-1193-02
190x57 mm

Kelly
27cm/10½"



Polloson
06-1194-27
27cm/10½"



Polloson
06-1195-27
27cm/10½"



06-1196-03
115x65 mm

06-1196-02
108x43 mm

06-1196-01
82x22 mm

Coryllos
23.0cm/9"



06-1197-25
125x37 mm

Sauerbruch
25cm/10"

General Instruments

Retractors and Lung Spatulas
Retraktoren und Lungenforschung Spatel

Rétracteurs Spatules et du poumon
Los retractoros y espátulas de pulmón



Deaver
06-1198-01
18 cm/7"



Deaver
06-1199-02
21.5 cm/8½"



Deaver
06-1200-03
23 cm/9"



Deaver
06-1201-04 30cm/12"
06-1201-05 33cm/13"
06-1201-06 36cm/14"



Deaver
30 cm/12"

- 06-1202-07 38 mm
- 06-1202-08 50 mm
- 06-1202-09 75 mm



Deaver Grip-Handle
06-1203-01 25 mm
06-1203-02 38 mm
06-1203-03 50 mm
06-1203-04 75 mm
30 cm/12"



Harrington-Baby
06-1204-01
25 cm/10"
24x70 mm
Harrington
06-1204-02
06-1204-03
32 cm/12½"
40x127 mm
62x127 mm
Harrington
06-1204-04
29.5 cm/11½"
64x175 mm

General Instruments

Retractors
Retraktoren

Rétracteurs
Retractoros



Meyerding

- 06-1205-01
50x16 mm 20cm/8"
- 06-1205-02
75x25 mm 22cm/8¾"
- 06-1205-03
90x50 mm 24cm/9½"

Zenker

- 06-1206-01 25cm/10" 35x08 mm
- 06-1206-02 26cm10¼" 60x12 mm
- 06-1206-03 27.5cm/10¾" 75x12 mm

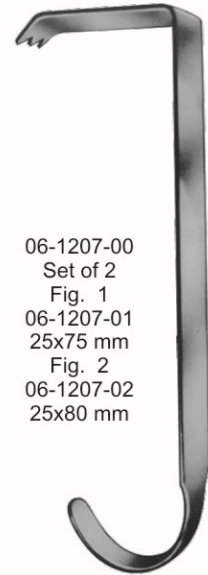

- 06-1207-00
Set of 2
Fig. 1
- 06-1207-01
25x75 mm
Fig. 2
- 06-1207-02
25x80 mm

Hibbs
24cm/9½"

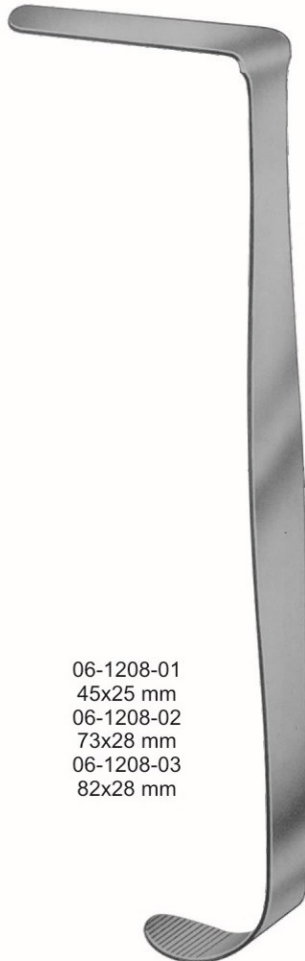

- 06-1208-01
45x25 mm
- 06-1208-02
73x28 mm
- 06-1208-03
82x28 mm

Heaney
27cm/10½"

46 mm



Kuemmel
06-1209-33
33cm/13"

120x47 mm

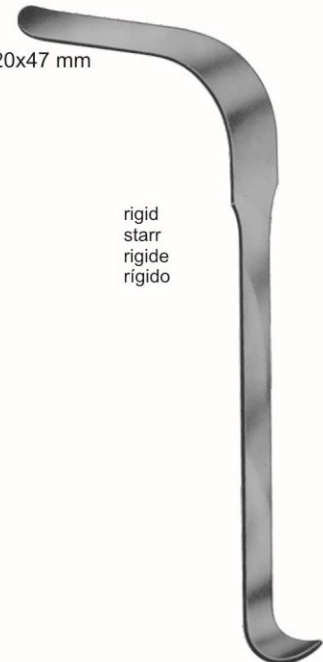

rigid
starr
rigide
rigido

Koerte
06-1210-28
28cm/11"

General Instruments

Abdominal and Intestinal Spatulas
Bauch-und Darm-Spatel

Spatules abdominale et intestinale
Espátulas abdominales e intestinales



Kader
06-1211-01 20mm
06-1211-02 30mm
06-1211-03 40mm
27cm/10 1/2"



06-1212-01
25.5cm/10"
45 mm
06-1212-02
27.5cm/10 3/4"
60 mm

Leriche



Malleable
formbar
malléable
maleable

- 06-1213-01 20 mm
- 06-1213-02 25 mm
- 06-1213-03 30 mm
- 06-1213-04 35 mm
- 06-1213-05 40 mm
- 06-1213-06 45 mm
- 06-1213-07 50 mm
- 06-1213-08 64 mm
- 06-1213-09 76 mm
- 06-1213-10 102 mm
33cm/13"

Malleable
formbar
malléable
maleable



Malleable
formbar
malléable
maleable

- 06-1215-01
200x6 mm
- 06-1215-02
200x8 mm
- 06-1215-03
200x10 mm
- 06-1215-04
200x12 mm
- 06-1215-05
200x17 mm
- 06-1215-06
200x20 mm
- 06-1215-07
200x25 mm
- 06-1215-08
250x25 mm

Tuffier
06-1214-20
20 cm/8"
17x25 mm



20cm/8"

Malleable
formbar
malléable
maleable

- 06-1216-01
280x25/30 mm
- 06-1216-02
300x37/45 mm
- 06-1216-03
300x40/50 mm



Haberer



Reverdin
06-1217-28
28 cm/11"



Davidson
16cm/6¼"

75x50 mm
75x90 mm

06-1218-01
06-1218-02



Cooley
06-1219-01
21.5cm/8½"

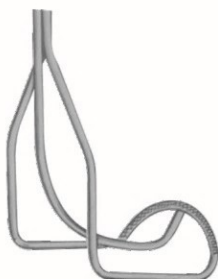

Cooley
06-1220-01
21.5cm/8½"



Cooley
06-1220-02
23cm/9"



Ross
27cm/10½"

- Fig. 1 06-1222-01 13x13 mm
- Fig. 2 06-1222-02 14x12 mm
- Fig. 3 06-1222-03 18x18 mm
- Fig. 4 06-1222-04 20x20 mm
- Fig. 5 06-1222-05 22x18 mm
- Fig. 6 06-1222-06 26x24 mm

General Instruments

Retractors for Maxillofacial Surgery
Retraktoren für Kiefer-und Gesichtschirurgie

Rétracteurs pour la chirurgie maxillo-faciale
Los retractoros para cirugía maxilofacial

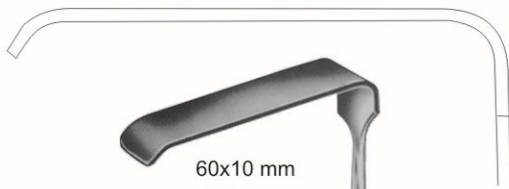

60x10 mm

Kirsch
06-1223-01
20cm/8"

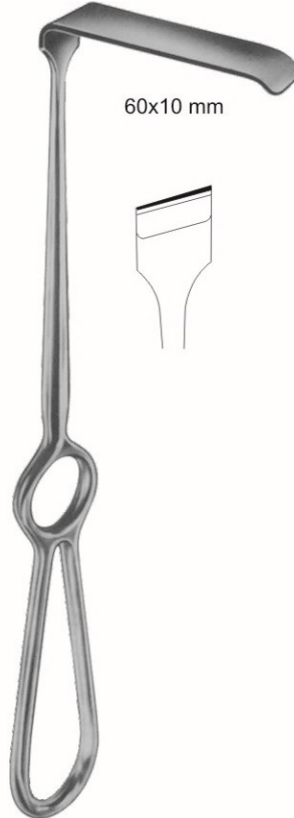

60x10 mm

Kirsch
06-1224-02
20cm/8"



Set
setzen
fixer
establecer
06-1225-00

06-1225-01
24.5cm/10"

06-1225-02
24.5cm/10"

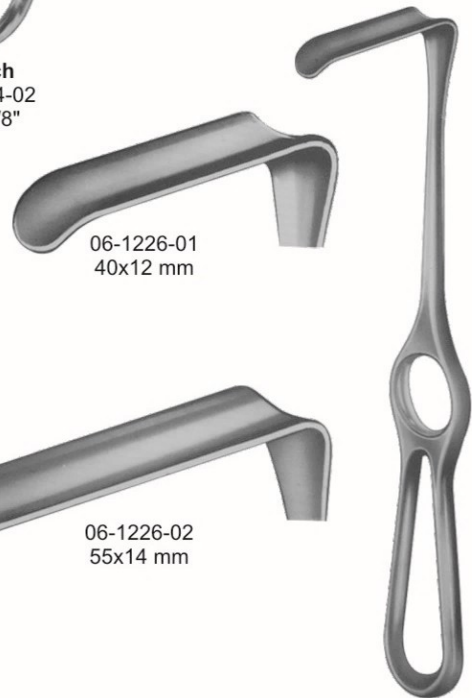

06-1226-01
40x12 mm

06-1226-02
55x14 mm

Dockhorn
20cm/8"

General Instruments

Retractors for Maxillofacial Surgery
Retraktoren für Kiefer-und Gesichtschirurgie

Rétracteurs pour la chirurgie maxillo-faciale
Los retractoros para cirugía maxilofacial

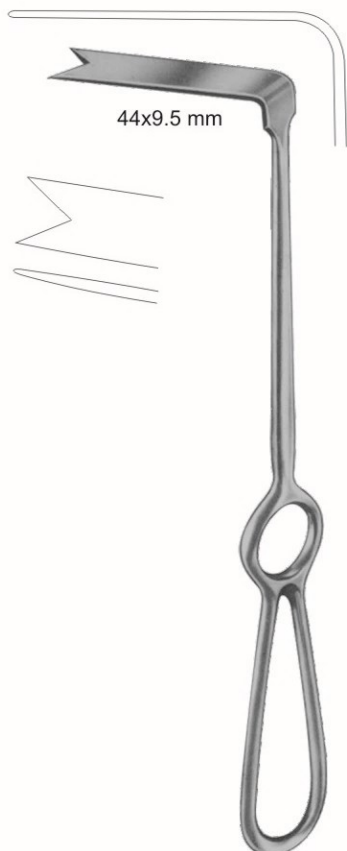

44x9.5 mm

Spina-Nalis
06-1227-01
22 cm/8¾"

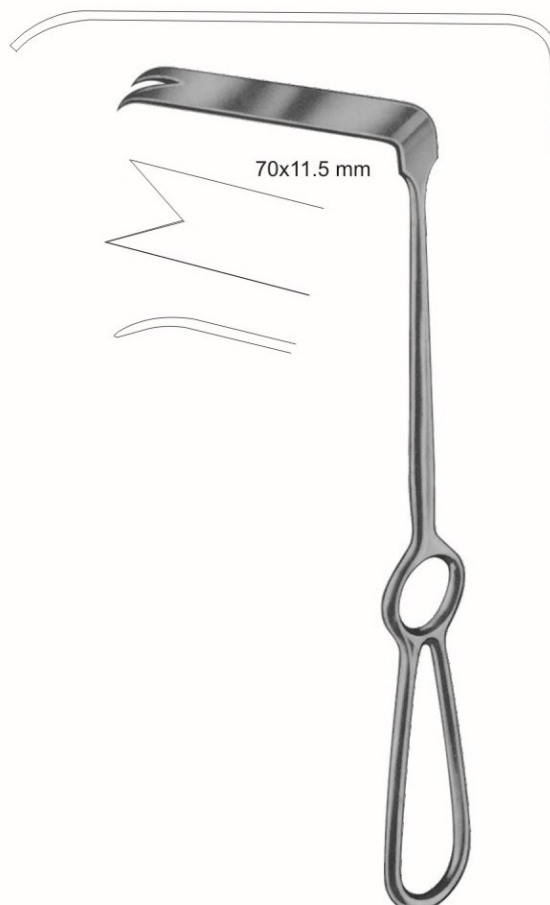

70x11.5 mm

Ramus
06-1228-02
22 cm/8¾"



Obwegeser
06-1229-15
15.5 cm/6"



Obwegeser
06-1230-16
16 cm/6¼"

General Instruments

Retractors for Maxillofacial Surgery
Retraktoren für Kiefer-und Gesichtschirurgie

Rétracteurs pour la chirurgie maxillo-faciale
Los retractoros para cirugía maxilofacial



06-1231-10 10 mm
06-1231-20 20 mm
19cm/7½"



Dingman
06-1232-17
17.5cm/7"



Soeresen-Hein
06-1233-17
17.5cm/7"



Dingman
06-1234-21
21cm/8¼"



06-1235-18
18.5cm/7"

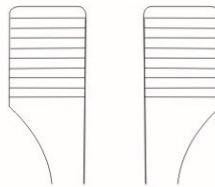

Tessier
06-1236-01
15cm/6"



Tessier
06-1236-02
15cm/6"



Dingman
06-1237-00

General Instruments

Retractors for Maxillofacial Surgery
Retraktoren für Kiefer-und Gesichtschirurgie

Rétracteurs pour la chirurgie maxillo-faciale
Los retractoros para cirugía maxilofacial



Obwegeser-Freer
06-1238-21
21cm/8¼"



Obwegeser-Freer
06-1239-20
20.5cm/8"

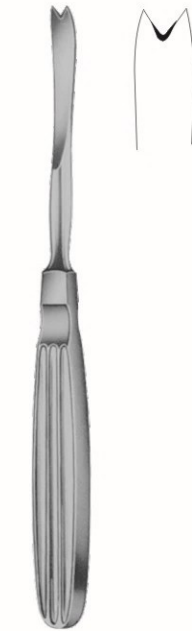

Obwegeser
06-1240-17
17.5cm/7"



Obwegeser
20cm/8"

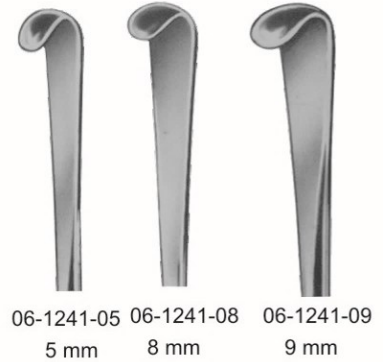

06-1241-05 5 mm
06-1241-08 8 mm
06-1241-09 9 mm



Obwegeser
17.5cm/7"



06-1242-06
6 mm



06-1242-07
7 mm



06-1242-09
9 mm



06-1242-11
11 mm



Dingman
06-1243-18
18cm/7"



Obwegeser
06-1244-23
23.5cm/9¼"
10 mm

General Instruments

Osteotome for Maxillofacial Surgery
Osteotome für Kiefer-und Gesichtschirurgie

Ostéotome pour Chirurgie Maxillo-Faciale
Osteotomo de Cirugía Maxilofacial



Tessier
20.5cm/8"



06-1245-10
10 mm



06-1246-10
10 mm



Obwegeser
06-1247-01
18.5cm/7 1/4"



Obwegeser
06-1248-02
18.5cm/7 1/4"



06-1249-07
7 mm
21.5cm/8 1/2"



06-1250-10
10 mm
21.5cm/8 1/2"



15cm/6"



06-1251-02
2.5 mm



06-1251-04
4 mm



Bowdler-Henry's
06-1252-16
16.5cm/6 1/2"



Gillies
06-1253-21
21cm/8 1/4"



Gillies
06-1254-21
21cm/8 1/4"

General Instruments

Awls for Maxillofacial Surgery
Ahlen für Kiefer-und Gesichtschirurgie

Alènes pour Chirurgie Maxillo-Faciale
Punzones de Cirugía Oral y Maxilofacial



Sanders-Brown
06-1255-30
30cm/12"



Sanders-Brown
06-1256-29
29cm/11½"



Obwegeser
06-1257-14
14cm/5½"



Obwegeser
06-1258-23
23cm/9"



Obwegeser
06-1259-18
18cm/7"



Kelsey-Fry
06-1260-16
15cm/6"



Kelsey-Fry
06-1261-18
18cm/7"



Mershon
06-1262-14
14.5cm/5½"

Band Pusher
Pusher Band

General Instruments

Retractors
Retraktoren

Rétracteurs
Retradores



Bose



Finsen



Finsen

Sharp
scharf
net
agudo

blunt
stumpf
émousser
embotar

Sharp
scharf
net
agudo

cm	in					
5	2		06-1263-05	06-1264-05	06-1265-05	
7	2¾"	11-0740-07	06-1263-07	06-1264-07	06-1265-07	Blunt



Allport

06-1267-09
9.5cm/3¾"



Alm

blunt
stumpf
émousser
embotar

Sharp
scharf
net
agudo

cm	in		cm	in		
8.5	3½"	06-1266-08	7	2¾"	06-1268-07	06-1269-07
11.5	4½"	06-1266-11	10	4	06-1268-10	06-1269-10

General Instruments

Retractors
Retraktoren

Rétracteurs
Retractoros



Sharp
scharf
net
agudo

Holzheimer

blunt
stumpf
émousser
embotar

06-1270-10 10 cm/4" 06-1271-10



Sharp
scharf
net
agudo

Jansen

blunt
stumpf
émousser
embotar

06-1272-10 10.5 cm/4¼" 06-1273-10



Sharp
scharf
net
agudo

Jansen-Deep

blunt
stumpf
émousser
embotar

06-1274-10 10.5 cm/4¼" 06-1275-10



Belucci

06-1276-11 11.5cm/4½"
06-1276-13 13cm/5"



Belucci

06-1277-11
06-1277-13



Sharp
scharf
net
agudo

Plester

blunt
stumpf
émousser
embotar

06-1278-13 13 cm/5" 06-1279-13

General Instruments

Retractors
Retraktoren

Rétracteurs
Retradores



Sharp
scharf
net
agudo

Weitlaner

blunt
stumpf
émousser
embotar

06-1281-10



Sharp
scharf
net
agudo

Weitlaner

blunt
stumpf
émousser
embotar

06-1282-13

06-1283-13

06-1282-16

06-1283-16



Weitlaner-Wullstein

Sharp
scharf
net
agudo

blunt
stumpf
émousser
embotar

06-1284-13

06-1285-13

06-1284-16

06-1285-16

10.5 cm/4¼"
13 cm/5"
16.5 cm/6½"

06-1280-10



Mollison
06-1286-15
15 cm/6"



Tuebinger-Modell
06-1287-16
16 cm/6¼"



Henner(Lempert)
06-1288-12
12 cm/4½"

Complete with 2 pairs of blades and centre blade
Komplett mit 2 Paar Klängen und mittlere Klängen
Livré avec 2 paires de les lames et les lames centre
Completo con 2 pares de cuchillas y la cuchilla centro

General Instruments

Retractors
Retraktoren

Rétracteurs
Retractoros

Complete with 3 Central blades
Komplett mit 3 Central Klängen
Livré avec 3 lames centrales
Completo con 3 cuchillas centrales



Sharp
scharf
net
agudo

Henley

blunt
stumpf
émousser
embotar

06-1289-16 16.5 cm/6½" 06-1290-16

Central blades, only
Zentral Klängen, nur
Lames centrales, ne
Hojas centrales, sólo



06-1291-19
16x19 mm

06-1291-25
16x25 mm

06-1291-32
16x32 mm

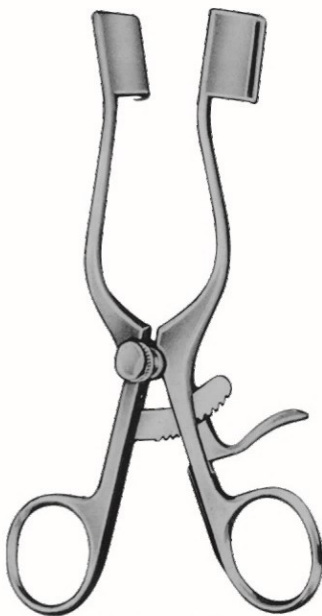

Weitlaner-Baby

13 cm/5"
16 cm/6¼" 06-1292-13



Milligan

Sharp
scharf
net
agudo

blunt
stumpf
émousser
embotar

06-1293-13 06-1294-13



Cone (Adson-Baby)

Sharp
scharf
net
agudo

blunt
stumpf
émousser
embotar

06-1295-13 06-1296-13
06-1295-16 06-1296-16

General Instruments

Retractors
Retraktoren

Rétracteurs
Retradores



Weitlaner

20 cm/8"
25 cm/10"



3x4 Teeth

Sharp
scharf
net
agudo

06-1297-20
06-1297-25

blunt
stumpf
émousser
embotar

06-1298-20
06-1298-25

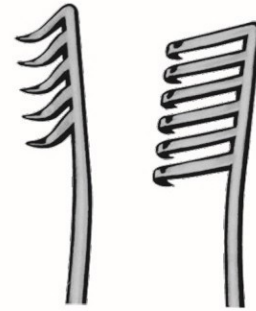

5x6 Teeth

Sharp
scharf
net
agudo

06-1299-25

blunt
stumpf
émousser
embotar

06-1300-25



Adson

Sharp
scharf
net
agudo

20 cm/8" 06-1301-20
26 cm/10¼" 06-1301-26

blunt
stumpf
émousser
embotar

06-1302-20
06-1302-26



Anderson-Adson

Sharp
scharf
net
agudo

06-1303-20

blunt
stumpf
émousser
embotar

06-1304-20



Cone

Sharp
scharf
net
agudo

06-1305-20
06-1305-26

blunt
stumpf
émousser
embotar

06-1306-20
06-1306-26



Travers
06-1307-21
21 cm/8¼"

Jaws Depth

25 mm
44 mm

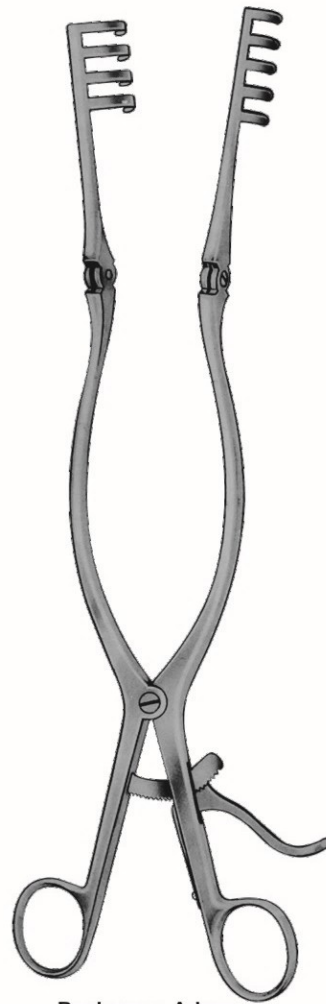

Beckmann-Adson

31 cm/12¼"

Sharp
scharf
net
agudo

06-1308-01
06-1308-02

blunt
stumpf
émousser
embotar

06-1309-01
06-1309-02



Adson
27 cm/10½"

Sharp
scharf
net
agudo

06-1310-27

blunt
stumpf
émousser
embotar

06-1311-27

General Instruments

Retractors
Retraktoren

Rétracteurs
Retractoros



5x6 Teeth

Sharp
scharf
net
agudo

Adson

blunt
stumpf
émousser
embotar

06-1312-27 27cm/10½" 06-1313-27



Beckmann

06-1314-01 10mm 14cm/5½"
06-1314-02 12mm 17cm/6¾"
06-1314-03 15mm 21cm/8¼"
06-1314-04 20mm
06-1314-05 30 mm
06-1314-06 50mm
30 cm/12"

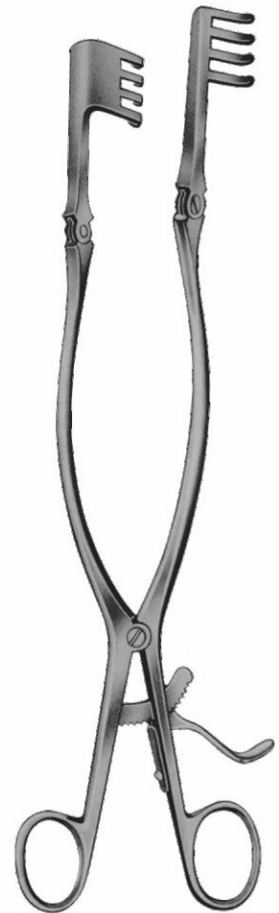

Sharp
scharf
net
agudo

BeckMann

blunt
stumpf
émousser
embotar

06-1315-31 31cm/12¼" 06-1315-31

General Instruments

Abdominal Retractors
Bauchdeckenhalter

Rétracteurs abdominale
Los retractoros abdominales

Hemilaminectomy Retractor
Hemilaminectomie Retraktor
enrouleur hémilaminectomie
hemilaminectomia retractor



06-1316-27
27cm/10½"



Beckmann-Eaton
06-1317-33
33 cm/13"

Retractors Only
Wundhaken Nur
Sólo Retractores...
Seulement Rétracteurs

Lateral Blades
seitlichen Flügel
lames latérales
cuchillas laterales

06-1318-01

06-1318-02

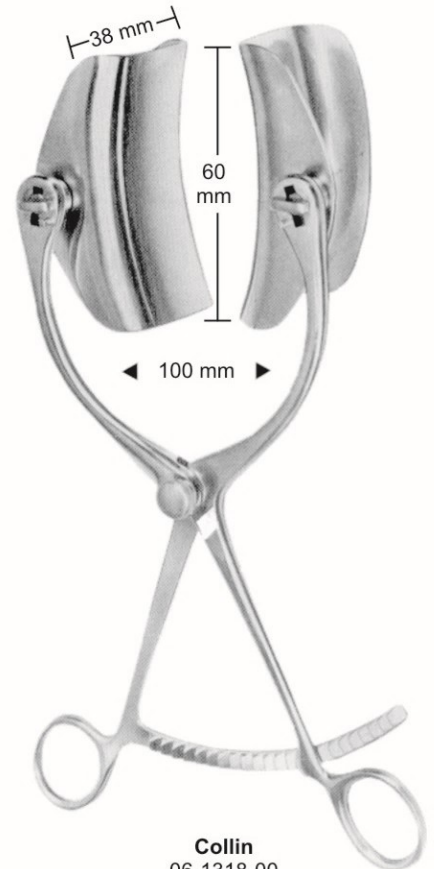

Collin
06-1318-00
22cm/8¾"

General Instruments

Abdominal Retractors
Bauchdeckenhalter

Rétracteurs abdominale
Los retractoros abdominales



Collin
22 cm/8¾"

Retractors Complete
Wundhaken Vollständige
Ecarteurs complètes
Retractoros completos

Retractors Only
Wundhaken Nur
Sólo Retractoros...
Seulement Rétracteurs

Lateral Blades
seitlichen Flügel
lames latérales
cuchillas laterales

Central Blades
zentralen Klingen
lames centrales
paletas centrales

Fig. 1
06-1319-00

Fig. 2
06-1320-00

Fig. 3
06-1321-00

06-1319-01

06-1320-01

06-1321-01

06-1319-02
38x60 mm

06-1320-02
38x80 mm

06-1321-02
38x100 mm

06-1319-03
55x55 mm

06-1321-03
55x75 mm

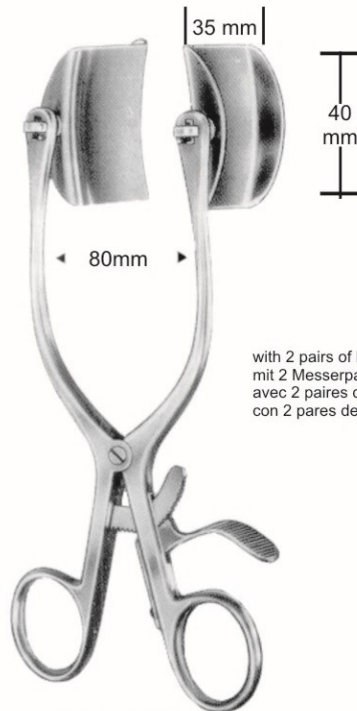

Baby-Collin
06-1322-00
18 cm/7"

with 2 pairs of blades
mit 2 Messerpaaren
avec 2 paires de lames
con 2 pares de cuchillas

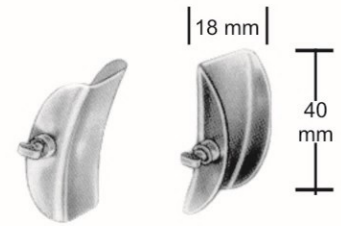

06-1322-01

General Instruments

Abdominal Retractors
Bauchdeckenhalter

Rétracteurs abdominale
Los retractoros abdominales



Markham-Meyering

06-1333-18 18cm/7" 06-1334-18

Rigby

06-1335-19
19cm/7½"

De Bakey

06-1336-12 12cm/4¾"
06-1336-17 17cm/6¾"

10cm/4"

40x30mm

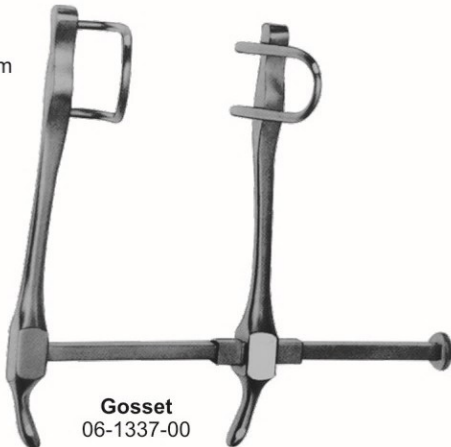

Gosset
06-1337-00

140mm

63x35mm



Gosset
06-1338-00

General Instruments

Abdominal Retractors
Bauchdeckenhalter

Rétracteurs abdominale
Los retractoros abdominales



Gosset
06-1339-16

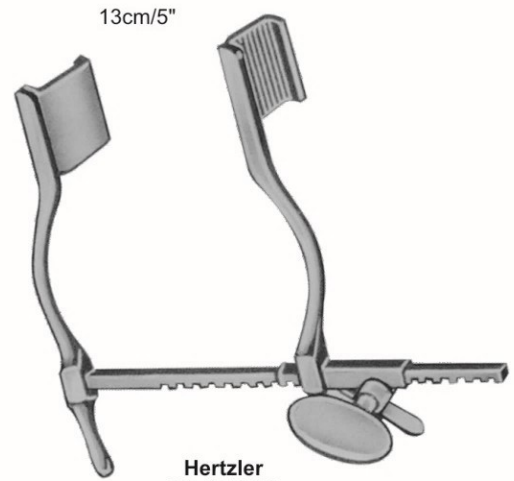

Hertzler
06-1340-00

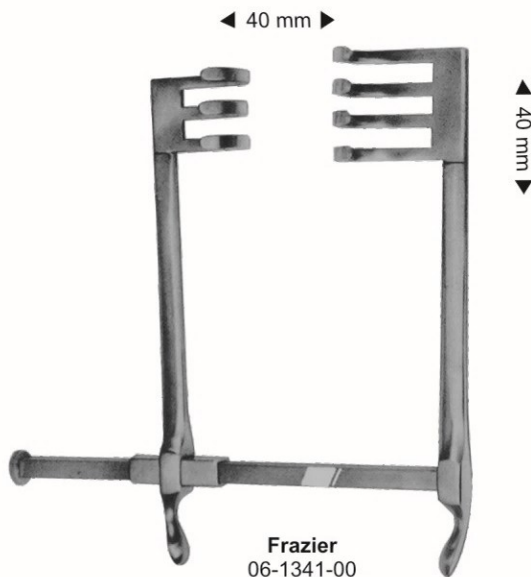

Frazier
06-1341-00

General Instruments

Retractors
Retraktoren

Rétracteurs
Retractoros

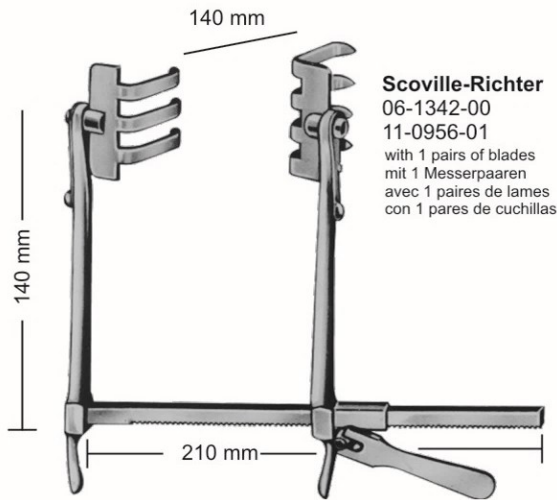

Scoville-Richter
06-1342-00
11-0956-01
with 1 pairs of blades
mit 1 Messerpaaren
avec 1 paires de lames
con 1 pares de cuchillas

the blades are available by pairs
die Schaufeln sind durch Paare
les lames sont disponibles par paires
Las cuchillas están disponibles por pares



06-1343-01
60x50 mm

06-1343-02
48x50 mm



06-1343-03
28x40 mm



06-1343-04
38x62 mm

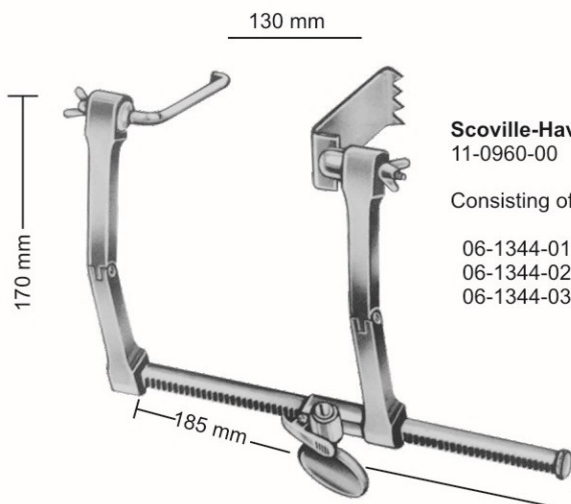

Scoville-Haverfield
11-0960-00
Consisting of:
06-1344-01
06-1344-02
06-1344-03



Scoville
06-1345-02
51 mm



Scoville
06-1345-03 63x25 mm
06-1345-04 63x51 mm
06-1345-05 67x32 mm
06-1345-06 89x25 mm



Taylor
06-1345-07
48x38 mm



Taylor
06-1345-08 63x51 mm
06-1345-09 79x57 mm

General Instruments

Abdominal Retractors
Bauchdeckenhalter

Rétracteurs abdominale
Los retractoros abdominales

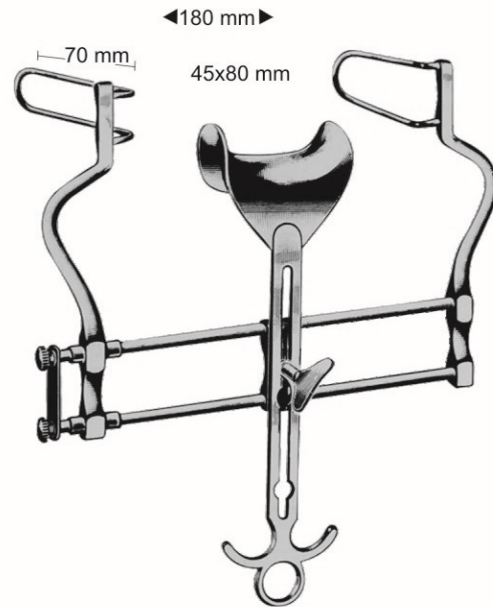
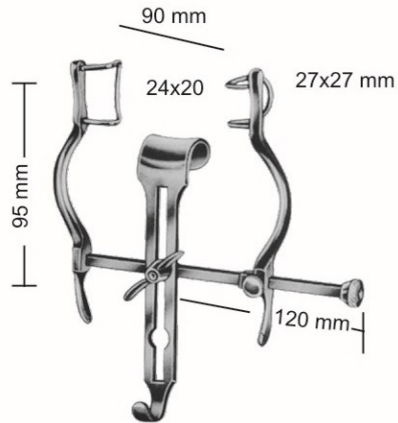

Retractors Complete
Wundhaken Vollständige
Ecarteurs complètes
Retractoros completos

Baby-Balfour
06-1346-00

Balfour
06-1347-18

Retractors Only
Wundhaken Nur
Sólo Retractoros...
Seulement Rétracteurs

06-1346-01

06-1347-01

Central Blades
zentralen Klängen
lames centrales
paletas centrales

06-1346-02
24x20mm

06-1347-02
45x80mm

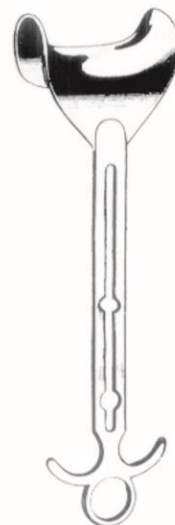

Balfour
06-1348-01 80x90mm

General Instruments

Abdominal Retractors
Bauchdeckenhalter

Rétracteurs abdominale
Los retractoros abdominales



Balfour

Retractors Complete
Wundhaken Vollständige
Ecarteurs complètes
Retractoros completos

06-1349-18

Retractors Only
Wundhaken Nur
Sólo Retractoros...
Seulement Rétracteurs

06-1349-01

Central Blades
zentralen Klängen
lames centrales
paletas centrales

06-1349-02

45x80mm

Solid blade

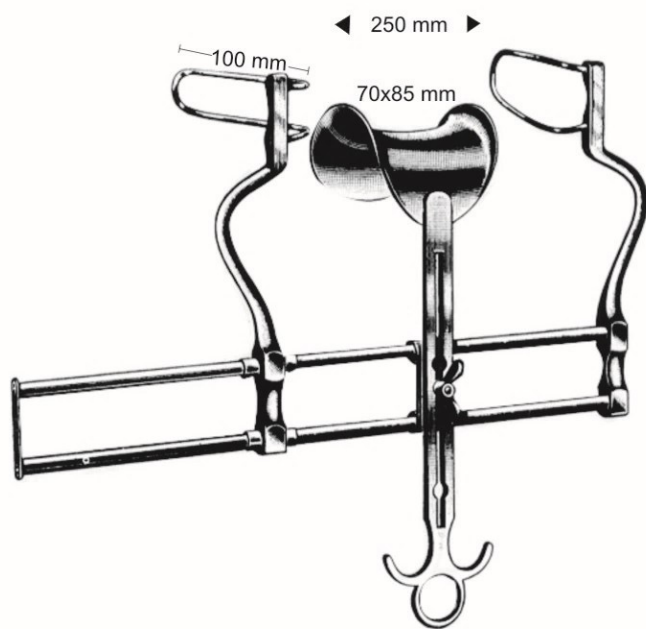

Balfour
06-1350-25

Retractors Complete
Wundhaken Vollständige
Ecarteurs complètes
Retractoros completos

06-1350-25

Retractors Only
Wundhaken Nur
Sólo Retractoros...
Seulement Rétracteurs

06-1350-01

Central Blades
zentralen Klängen
lames centrales
paletas centrales

06-1350-02

70x85mm

General Instruments

Abdominal Retractors
Bauchdeckenhalter

Rétracteurs abdominale
Los retractoros abdominales

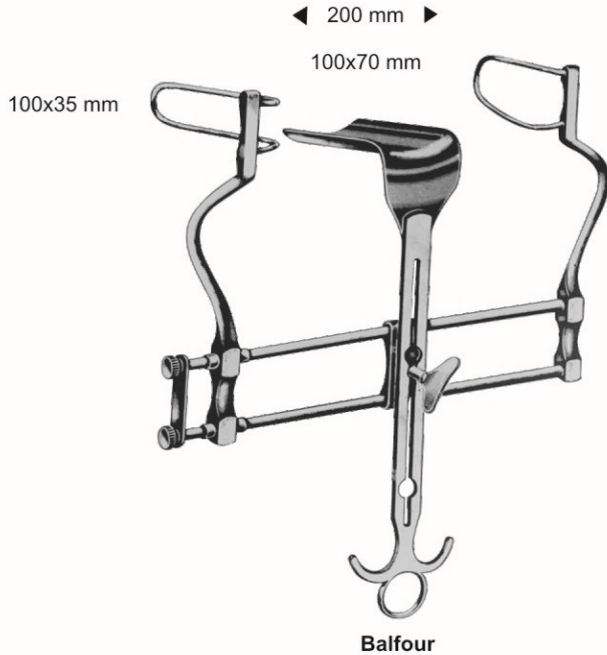

Retractors Complete
Wundhaken Vollständige
Ecarteurs complètes
Retractoros completos
06-1351-20

Retractors Only
Wundhaken Nur
Sólo Retractoros...
Seulement Rétracteurs
06-1351-01

Central Blades
zentralen Klängen
lames centrales
paletas centrales
06-1351-02
100x70mm

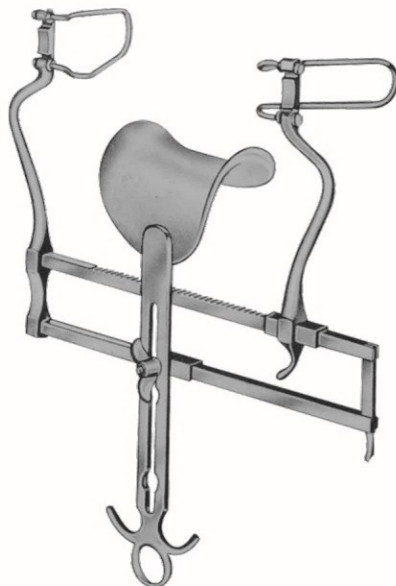

Balfour us-Type
06-1352-00
Complete



06-1353-01

Lateral blades, 6cm deep, per pair
seitliche Flügel, 6cm tief, pro Paar
lames latérales, 6cm de profondeur, par paire
cuchillas laterales, 6cm par profunda, por

06-1353-02

Lateral blades, 8cm deep, per pair
seitliche Flügel, 8cm tief, pro Paar
lames latérales, 8cm de profondeur, par paire
cuchillas laterales, 8cm par profunda, por

Central Blades only
zentralen Klängen Nur
lames centrales Sólo
Seulement paletas centrales

06-1353-03

40x68mm

06-1353-04

68x85mm

General Instruments

Abdominal Retractors
Bauchdeckenhalter

Rétracteurs abdominale
Los retractoros abdominales

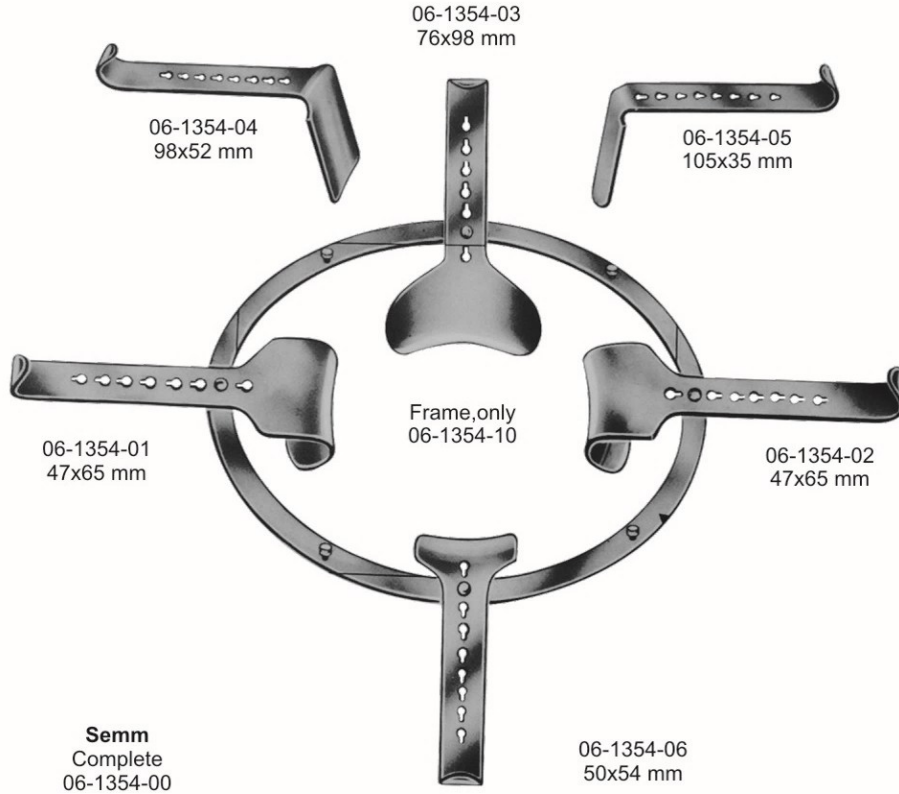

Complete
vervollständigen
compléter
completar

40x55 mm 06-1355-01
50x65 mm 06-1355-02
65x80 mm 06-1355-03
80x80 mm 06-1355-04
90x65 mm 06-1355-05
90x90 mm 06-1355-06



Complete
06-1356-00
1x 06-1356-10
2x 06-1356-01
2x 06-1356-02

General Instruments

Abdominal Retractors
Bauchdeckenhalter

Rétracteurs abdominale
Los retractoros abdominales

Frame
06-1357-10 178x140 mm
06-1358-20 255x178 mm

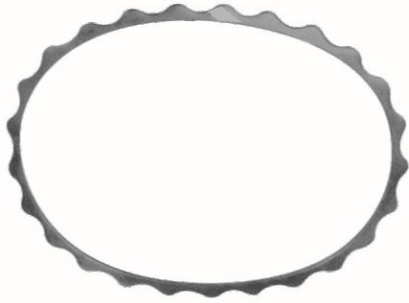

Complete
vervollständigen
compléter
completar
06-1357-00
06-1358-00

Denis-Brown
Consisting of
bestehend aus
composée d'
Compuesto por

1x 06-1359-10
1x 06-1360-20

Fig.1 06-1359-01 38x38 mm
Fig.2 06-1360-02 38x25 mm



2x 06-1359-01
2x 06-1360-01

2x 06-1359-02
2x 06-1360-02

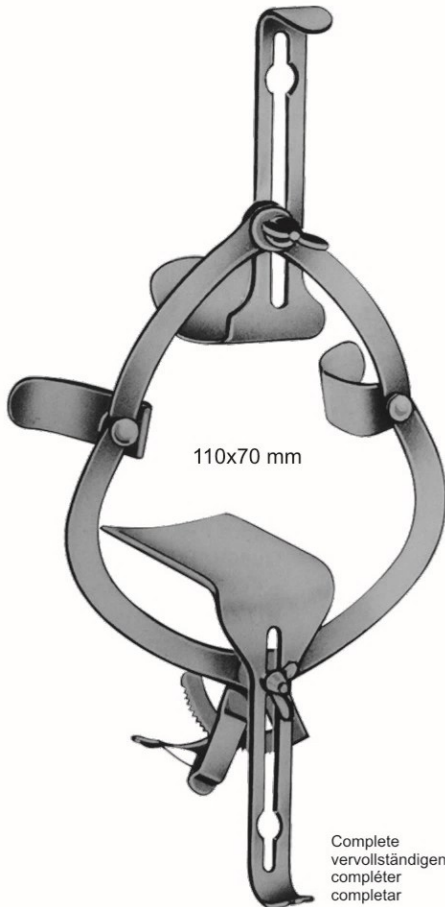

110x70 mm

Complete
vervollständigen
compléter
completar

O'Sullivan-O'Connor
06-1361-00

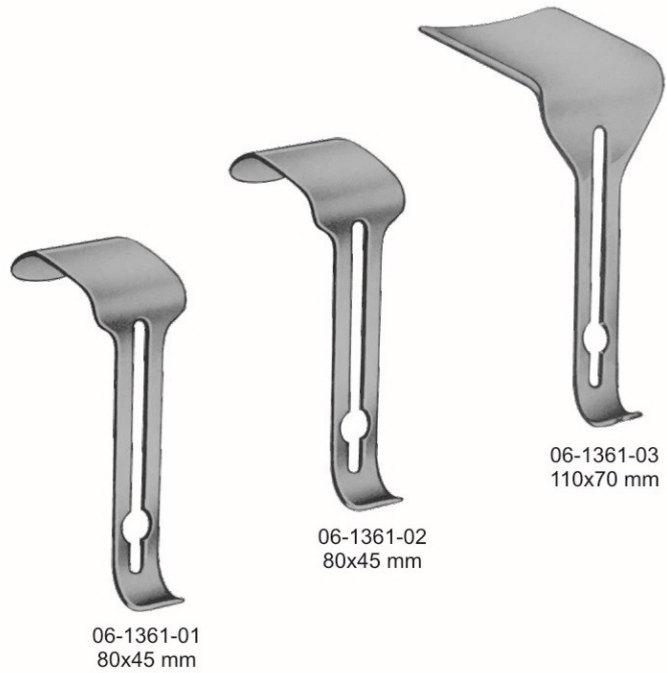

06-1361-01
80x45 mm

06-1361-02
80x45 mm

06-1361-03
110x70 mm

General Instruments

Abdominal Retractors
Bauchdeckenhalter

Rétracteurs abdominale
Los retractoros abdominales



Doyen
06-1362-01 48x90mm
06-1362-02 48x105mm
06-1362-03 48x120mm
06-1362-04 48x135 mm



Rochard
06-1363-01 40x80mm
06-1363-02 50x100mm
06-1363-03 55x120mm



Doyen-Rochard
06-1364-01 45x80mm
06-1364-02 50x100mm
06-1364-03 65x120mm

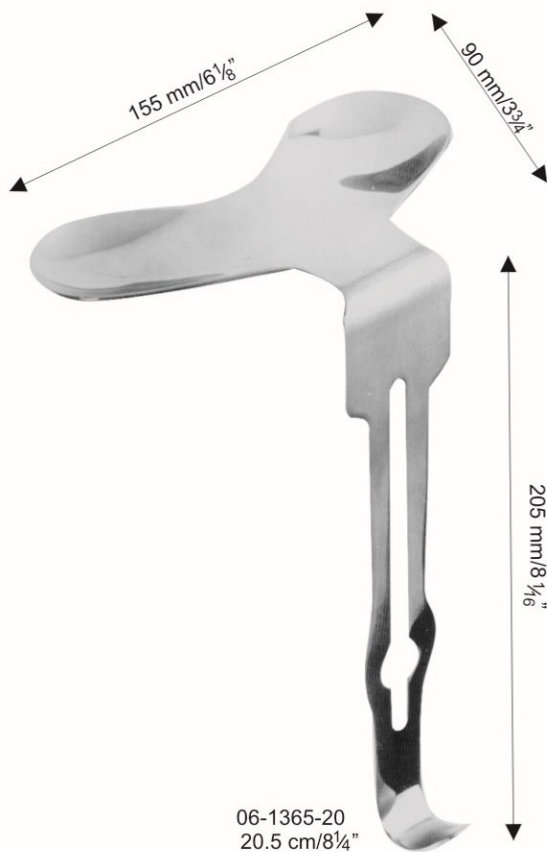

06-1365-20
20.5 cm/8 1/4"