

## General Instruments

Plaster Knives, Saw and Cast Breakers  
Gips Messer, Säge- und Cast Breakers

Breakers Couteaux plâtre, de sciage et de Cast  
Cuchillos de yeso, de sierra y el Elenco Breakers



**Hopkins**  
12-1728-20  
20 cm/8"



**Esmarch**  
12-1729-18  
18 cm/7"



**Reiner**  
12-1730-18  
18.5 cm/7¼"

Plaster Saw  
Gipssäge  
plâtre de scie  
yeso Saw



**Engel**  
12-1731-14  
14cm/5½"

# General Instruments

Plaster Spreaders  
Gips Spreizer

Epan dage de plâtre  
Separadores de yeso

**Accu-Med**<sup>®</sup>  
Instrument Co.



**Hennig**  
12-1732-28  
28 cm/11"



**Beeson**  
12-1733-30  
30 cm/12"



**Haglund-Stille**  
12-1734-28  
28 cm/11"



**Mod. USA**  
12-1735-23  
23 cm/9"

## General Instruments

Plaster Instruments  
Gips Instruments

Instruments de plâtre  
Instrumentos de yeso



**Wolf**  
12-1736-18 18cm/7"  
12-1736-24 24cm/9½"



**Stille**  
12-1737-24  
24cm/9½"



**Stille**  
12-1738-23 23cm/9"  
12-1738-26 26cm/9¼"  
12-1738-37 37cm/14½"

# Bone Instruments

Bone Chisels & Gouges  
Knochenmeißeln & Gouges

Bone ciseaux et gouges  
Cinceles y Gouges



**Inspector**  
16 cm/6¼"

- 12-1739-03  
3mm
- 12-1739-05  
5mm
- 12-1739-07  
7mm
- 12-1739-09  
9mm



**Passow**  
12 cm/4¾"

12-1740-02  
2.5mm

12-1740-03  
3.5mm



- Hautant**
- 12-1741-02 2mm
  - 12-1741-04 4mm
  - 12-1741-05 5mm
  - 12-1741-06 6mm
  - 12-1741-08 8mm
  - 12-1741-10 10mm
  - 12-1741-12 12mm
  - 13 cm/5¼"



- mm
- 06 12-1742-06
  - 12 12-1742-12
  - 18 12-1742-18



- Mod. USA**
- 12-1743-06
  - 12-1743-12
  - 12-1743-18
  - 16 cm/6¼"



- 12-1744-06
- 12-1744-12
- 12-1744-18

# Bone Instruments

Bone Chisels, Gouges and Osteotomes  
Knochenmeißeln, Gouges und Osteotome

Bone ciseaux, gouges et ostéotomes  
Cinceles, formones y osteotomos



Width  
Breite  
largeur  
ancho

mm	12-1745-04	12-1746-04	12-1747-04
04	12-1745-04	12-1746-04	12-1747-04
06	12-1745-06	12-1746-06	12-1747-06
08	12-1745-08	12-1746-08	12-1747-08
10	12-1745-10	12-1746-10	12-1747-10
12	12-1745-12	12-1746-12	12-1747-12
14	12-1745-14	12-1746-14	12-1747-14
16	12-1745-16	12-1746-16	12-1747-16

13.5 cm/5 1/4"

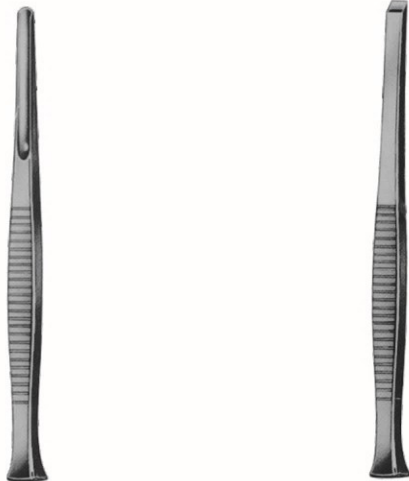

mm	Partsch	12-1749-02	Partsch	12-1751-04
02	12-1748-02	12-1749-02	12-1750-02	12-1751-04
03	12-1748-03	12-1749-03	12-1750-03	12-1751-06
04	12-1748-04	12-1749-04	12-1750-04	12-1751-08
05	12-1748-05	12-1749-05	12-1750-05	12-1751-10
06	12-1748-06	12-1749-06	12-1750-06	12-1751-12
07	12-1748-07	12-1749-07	12-1750-07	12-1751-14
08	12-1748-08	12-1749-08	12-1750-08	12-1751-16

13.5 cm/5 1/4"      17 cm/6 3/4"      13.5 cm/5 1/4"      17 cm/6 3/4"

12-1752-04	4mm
12-1752-06	6mm
12-1752-08	8mm
12-1752-10	10mm
12-1752-12	12mm
12-1752-14	14mm



**Poirioer**  
16cm/6"

12-1753-02	2mm
12-1753-04	4mm
12-1753-06	6mm
12-1753-08	8mm
12-1753-10	10mm
12-1753-12	12mm
12-1753-14	14mm



**Poirioer**  
16cm/6"

12-1754-04	4mm
12-1754-06	6mm
12-1754-08	8mm
12-1754-10	10mm
12-1754-12	12mm
12-1754-14	14mm



**Proirier Triuat**  
20cm/8"

# Bone Instruments

Bone Chisels, Gouges and Osteotomes  
Knochenmeißeln, Gouges und Osteotome

Bone ciseaux, gouges et ostéotomes  
Cinceles, formones y osteotomos







**Hautant**  
13 cm/5"

-  12-1755-02 2 mm
-  12-1755-04 4 mm
-  12-1755-05 5 mm
-  12-1755-06 6 mm
-  12-1755-08 8 mm
-  12-1755-10 10mm
-  12-1755-12 12mm





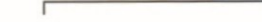





**Judet**  
22 cm/8<sup>3</sup>/<sub>4</sub>"

-  12-1756-10 10mm
-  12-1756-15 15mm
-  12-1756-20 20mm
-  12-1756-25 25mm
-  12-1756-30 30mm
-  12-1756-35 35mm









**Cauchoix**  
25 cm/10"

-  12-1757-08 8 mm
-  12-1757-10 10mm
-  12-1757-12 12mm
-  12-1757-14 14mm
-  12-1757-16 16mm
-  12-1757-18 18mm
-  12-1757-20 20mm
-  12-1757-25 25mm



**Cauchoix**  
25 cm/10"

-  12-1758-16 16mm
-  12-1758-18 18mm
-  12-1758-20 20mm
-  12-1759-16 16mm
-  12-1759-18 18mm
-  12-1759-20 20mm

## Bone Instruments

Bone Chisels, Gouges and Osteotomes  
Knochenmeißeln, Gouges und Osteotome

Bone ciseaux, gouges et ostéotomes  
Cinceles, formones y osteotomos



**Farabeuf**  
21 cm/8 $\frac{1}{4}$ "

- 12-1760-10 10mm
- 12-1760-15 15mm
- 12-1760-20 20mm
- 12-1760-25 25mm
- 12-1760-30 30mm



**Farabeuf**  
25 cm/10"

- 12-1761-06 6mm
- 12-1761-08 8mm
- 12-1761-10 10mm
- 12-1761-12 12mm

- 12-1761-15 15mm
- 12-1761-20 20mm
- 12-1761-25 25mm
- 12-1761-30 30mm



**Maceven**  
20 cm/8"

- 12-1762-10 10mm
- 12-1762-15 15mm
- 12-1762-20 20mm

# Bone Instruments

Bone Chisels, and Gouges  
Knochenmeißeln, und Gouges

Bone ciseaux, et gouges  
Cinceles, formones y



**Lexer**  
27.5 cm/10¾"

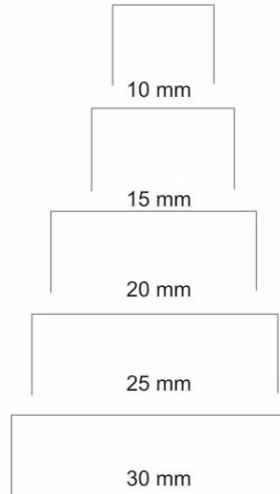

- 12-1763-10
- 12-1763-15
- 12-1763-20
- 12-1763-25
- 12-1763-30

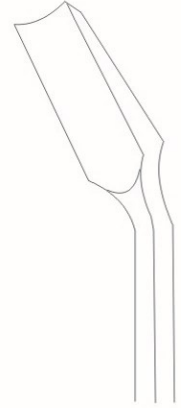

- 12-1764-10
- 12-1764-15
- 12-1764-20
- 12-1764-25
- 12-1764-30



**Alexander**  
18 cm/7"

- 12-1765-04
- 12-1765-06
- 12-1765-08
- 12-1765-10
- 12-1765-12
- 12-1765-14

- mm
- 04
- 06
- 08
- 10
- 12
- 14



- 12-1766-04
- 12-1766-06
- 12-1766-08
- 12-1766-10
- 12-1766-12
- 12-1766-14

# Bone Instruments

Bone Chisels, and Gouges Osteotomes  
Knochenmeißeln, und Gouges Osteotome

Bone ciseaux, et gouges ostéotomes  
Cinceles, formones y osteotomos

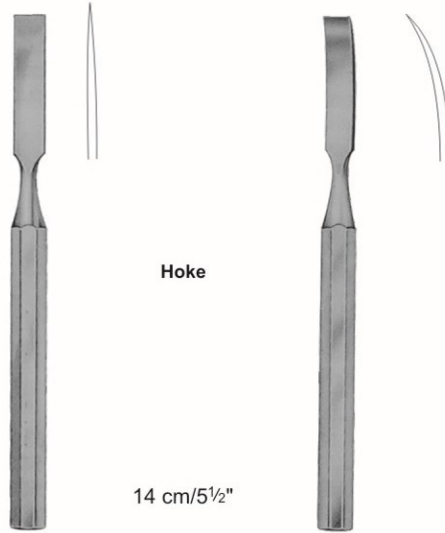

**Hoke**

14 cm/5½"

	mm	
12-1767-02	2	12-1768-02
12-1767-03	3	12-1768-03
12-1767-04	4	12-1768-04
12-1767-05	5	12-1768-05
12-1767-06	6	12-1768-06
12-1767-07	7	12-1768-07
12-1767-08	8	12-1768-08



**Smith-Petersen**  
20 cm/8"



mm				
06	12-1769-06	12-1770-06	12-1771-06	12-1772-06
09	12-1769-09	12-1770-09	12-1771-09	12-1772-09
13	12-1769-13	12-1770-13		
14			12-1771-14	12-1772-14
16	12-1769-16	12-1770-16	12-1771-16	12-1772-16
19	12-1769-19	12-1770-19	12-1771-19	12-1772-19
25	12-1769-25	12-1770-25	12-1771-25	12-1772-25
32	12-1769-32	12-1770-32	12-1771-32	12-1772-32

# Bone Instruments

Bone Chisels, and Gouges Osteotomes  
Knochenmeißeln, und Gouges Osteotome

Bone ciseaux, et gouges ostéotomes  
Cinceles, formones y osteotomos



### Lambotte mm

12-1773-04	04	12-1774-04
12-1773-06	06	12-1774-06
12-1773-08	08	12-1774-08
12-1773-10	10	12-1774-10
12-1773-13	13	12-1774-13
12-1773-16	16	12-1774-16
12-1773-18	18	12-1774-18
12-1773-20	20	12-1774-20
12-1773-25	25	12-1774-25
12-1773-30	30	12-1774-30
12-1773-38	38	12-1774-38
12-1773-44	44	12-1774-44
12-1773-50	50	12-1774-50
24 cm/9½"		23 cm/9"

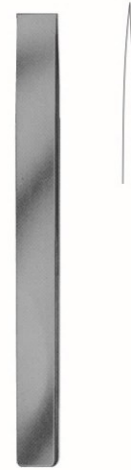
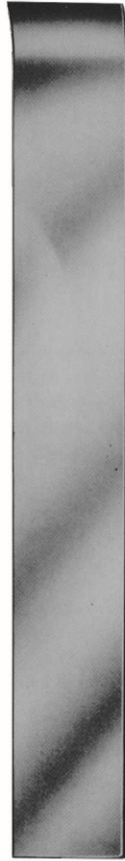

### Mini-Lambotte mm

12-1775-02	02	12-1776-02
12-1775-03	03	12-1776-03
12-1775-04	04	12-1776-04
12-1775-06	06	12-1776-06
12-1775-08	08	12-1776-08
12-1775-10	10	12-1776-10
12-1775-12	12	12-1776-12
12-1775-15	15	12-1776-15
12.5 cm/5"		17 cm/6¾"



### Mini-Lexer mm

12-1777-04	04	12-1778-04
12-1777-06	06	12-1778-06
12-1777-08	08	12-1778-08
12-1777-10	10	12-1778-10
12-1777-12	12	12-1778-12

18 cm/7"



### Lexer mm

12-1779-05	05	12-1780-05
12-1779-07	07	12-1780-07
12-1779-10	10	12-1780-10
12-1779-15	15	12-1780-15
12-1779-20	20	12-1780-20
12-1779-25	25	12-1780-25
12-1779-30	30	12-1780-30

22 cm/8¾"



## Bone Instruments

Bone Chisels, and Gouges  
Knochenmeißeln, und Gouges

Bone ciseaux, et gouges  
Cinceles, formones y



**Chisel**  
12-1781-20  
24.5 cm/9¾"  
20 mm



**Chisel-Curved**  
12-1782-20  
26.5 cm/10½"  
20 mm

Gouge for the removing of  
broken screws  
Hohlmeißel für das Entfernen von  
abgebrochener Schrauben  
Gouge pour la suppression de vis cassées  
Gubia para la remoción de tornillos rotos



12-1783-22  
22 cm/8¾"

# Bone Instruments

Bone Chisels, and Gouges Osteotomes  
Knochenmeißeln, und Gouges Osteotome

Bone ciseaux, et gouges ostéotomes  
Cinceles, formones y osteotomos



**Zielke**  
23 cm/9"  
5.5 mm  
9.0 mm

12-1784-05  
12-1784-09

Width  
Breite  
largeur  
ancho



mm	12-1784-06	12-1785-06	12-1786-06	12-1787-06	12-1788-06
06	12-1784-06	12-1785-06	12-1786-06	12-1787-06	12-1788-06
08	12-1784-08	12-1785-08	12-1786-08	12-1787-08	12-1788-08
10	12-1784-10	12-1785-10	12-1786-10	12-1787-10	12-1788-10
12	12-1784-12	12-1785-12	12-1786-12	12-1787-12	12-1788-12
15	12-1784-15	12-1785-15	12-1786-15	12-1787-15	12-1788-15
20	12-1784-20	12-1785-20	12-1786-20	12-1787-20	12-1788-20
25	12-1784-25	12-1785-25	12-1786-25	12-1787-25	12-1788-25
30	12-1784-30	12-1785-30	12-1786-30	12-1787-30	12-1788-30

**Stille**  
20 cm/8"



mm	12-1789-06	12-1790-06	12-1791-06	12-1792-06	12-1793-06
06	12-1789-06	12-1790-06	12-1791-06	12-1792-06	12-1793-06
09	12-1789-09	12-1790-09	12-1791-09	12-1792-09	12-1793-09
13	12-1789-13	12-1790-13	12-1791-13	12-1792-13	12-1793-13
16	12-1789-16	12-1790-16	12-1791-16	12-1792-16	12-1793-16
19	12-1789-19	12-1790-19	12-1791-19	12-1792-19	12-1793-19
25	12-1789-25	12-1790-25	12-1791-25	12-1792-25	12-1793-25
32	12-1789-32	12-1790-32	12-1791-32	12-1792-32	12-1793-32

**Hibbs**  
24 cm/9½"

## Bone Instruments

Bone Gouges  
Knochen Gouges

Gouges os  
Gouges hueso



mm **Lexer**  
05 12-1794-05  
10 12-1794-10  
15 12-1794-15

28 cm/11"



**Lexer**  
12-1795-05  
12-1795-10  
12-1795-15

25 cm/10"



**Lexer**  
12-1796-05  
12-1796-10  
12-1796-15

25 cm/10"



12-1797-01



12-1797-02



12-1798-03



**Cobb**  
28 cm/11"

12-1799-04

# Bone Instruments

Bone Curettes  
Scharfe Löffel

Curettes osseuses  
Curetas óseas

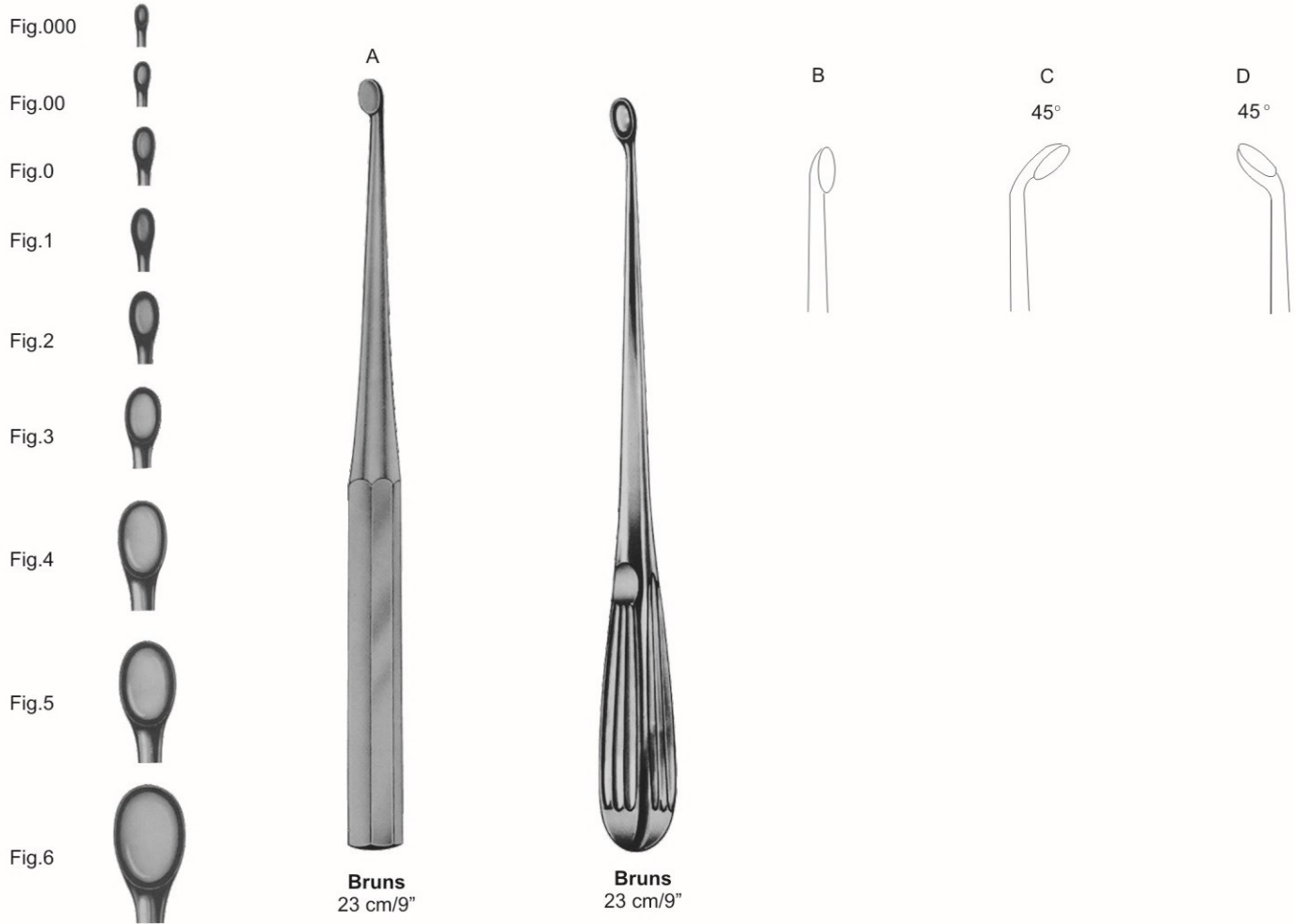

Fig.	A	B	C	D
000	12-1800-30	12-1801-30	12-1802-30	12-1803-30
00	12-1800-20	12-1801-20	12-1802-20	12-1803-20
0	12-1800-10	12-1801-10	12-1802-10	12-1803-10
1	12-1800-01	12-1801-01	12-1802-01	12-1803-01
2	12-1800-02	12-1801-02	12-1802-02	12-1803-02
3	12-1800-03	12-1801-03	12-1802-03	12-1803-03
4	12-1800-04	12-1801-04	12-1802-04	12-1803-04
5	12-1800-05	12-1801-05	12-1802-05	12-1803-05
6	12-1800-06	12-1801-06	12-1802-06	12-1803-06

## Bone Instruments

Bone Curettes  
Scharfe Löffel

Curettes osseuses  
Curetas óseas



**Volkmann**  
17 cm/6¾"

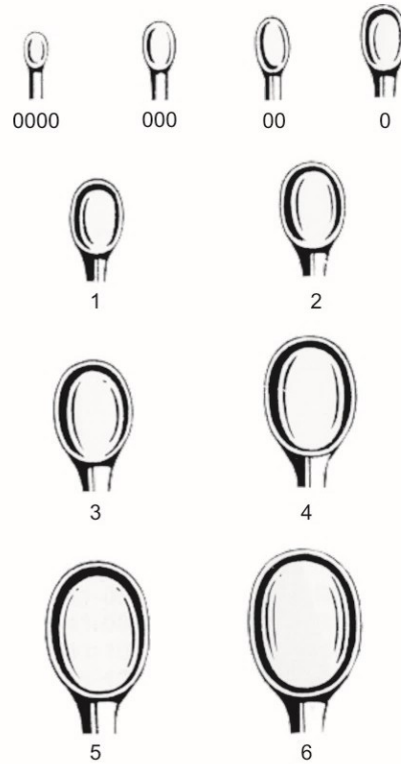

- Fig.  
0000 12-1804-40  
000 12-1804-30  
00 12-1804-20  
0 12-1804-10  
1 12-1804-01  
2 12-1804-02  
3 12-1804-03  
4 12-1804-04  
5 12-1804-05  
6 12-1804-06



**Volkmann**  
17 cm/6¾"

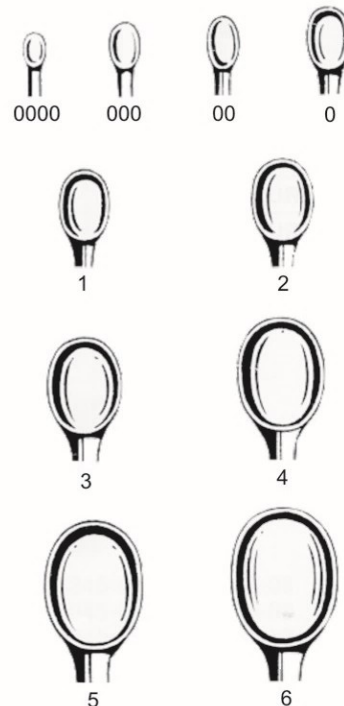

- Fig.  
0000 12-1805-40  
000 12-1805-30  
00 12-1805-20  
0 12-1805-10  
1 12-1805-01  
2 12-1805-02  
3 12-1805-03  
4 12-1805-04  
5 12-1805-05  
6 12-1805-06

# Bone Instruments

Bone Curettes  
Scharfe Löffel

Curettes osseuses  
Curettes óseas



**Bruns**  
17 cm/6 3/4"

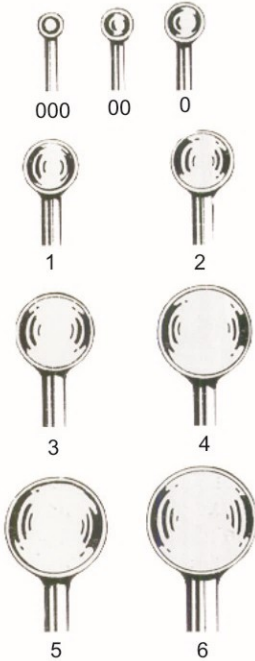

Bruns	Fig.
12-1806-30	000
12-1806-20	00
12-1806-10	0
12-1806-01	1
12-1806-02	2
12-1806-03	3
12-1806-04	4
12-1806-05	5
12-1806-06	6



**Spratt**  
16 cm/6 1/4"

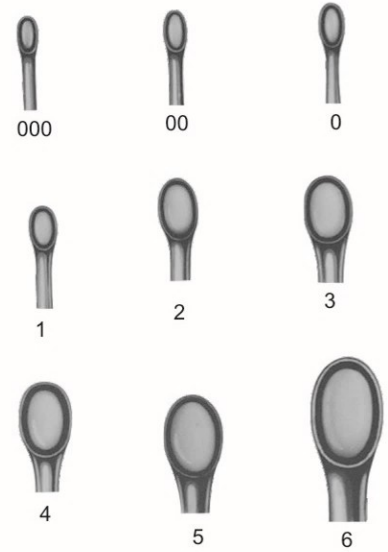

Spratt	Fig.
12-1807-30	000
12-1807-20	00
12-1807-10	0
12-1807-01	1
12-1807-02	2
12-1807-03	3
12-1807-04	4
12-1807-05	5
12-1807-06	6



**Swedish pattern**

mm	Round	Oval
2	12-1808-02	12-1809-03
3	12-1808-03	12-1809-04
4	12-1808-04	12-1809-05
5	12-1808-05	12-1809-06
6	12-1808-06	12-1809-07
7	12-1808-07	12-1809-08
8	12-1808-08	12-1809-10
10	12-1808-10	12-1809-12
12	12-1808-12	12-1809-14
14	12-1808-14	22cm/8 "
	17cm/6 3/4"	1/2

# Bone Instruments

Bone Currettes  
Scharfe Löffel

Currettes osseuses  
Curetas óseas



**Schede**  
17 cm/6<sup>3</sup>/<sub>4</sub>"

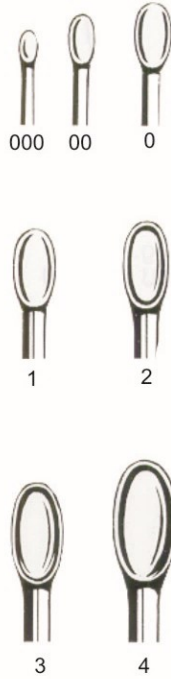
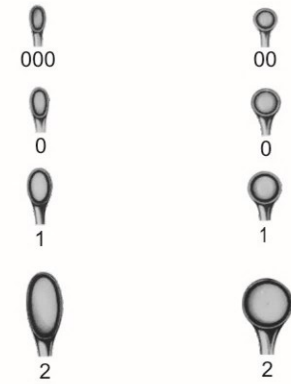

Fig.	
000	12-1810-30
00	12-1810-20
0	12-1810-10
1	12-1810-01
2	12-1810-02
3	12-1810-03
4	12-1810-04



**Williger**  
17.5 cm/7"



Straight, Oval	
Gerade, Oval	
Droite, ovale	
Oval Straight,	
12-1811-20	
12-1811-10	
12-1811-01	
12-1811-02	

Straight	
gerade	
droit	
recto	
Fig.	
00	12-1812-20
0	12-1812-10
1	12-1812-01
2	12-1812-02



12-1813-01

**Uffenorde**  
17 cm/6<sup>3</sup>/<sub>4</sub>"



12-1814-02

# Bone Instruments

Bone Curettes  
Scharfe Löffel

Curettes osseuses  
Curetas óseas



Fig. 0  
12-1815-10



Fig. 1  
12-1815-01



Fig. 2  
12-1815-02



Fig. 3  
12-1815-03



Fig. 1  
12-1816-01



Fig. 2  
12-1816-02



Fig. 3  
12-1816-03



Fig. 4  
12-1816-04



Fig. 5  
12-1816-05



Fig. 6  
12-1816-06



Fig. 0000  
12-1817-40



Fig. 000  
12-1817-30



Fig. 00  
12-1817-20



Fig. 0  
12-1817-10



Fig. 00  
12-1818-20



Fig. 0  
12-1818-10



Fig. 1  
12-1818-01



Fig. 2  
12-1818-02



**Volkman**  
27 cm/10½"



**Simon**  
24 cm/9½"



**Simon**  
24 cm/9½"



**Daubenspeck**  
20 cm/8"

# Bone Instruments

Bone Currettes  
Scharfe Löffel

Currettes osseuses  
Curetas óseas

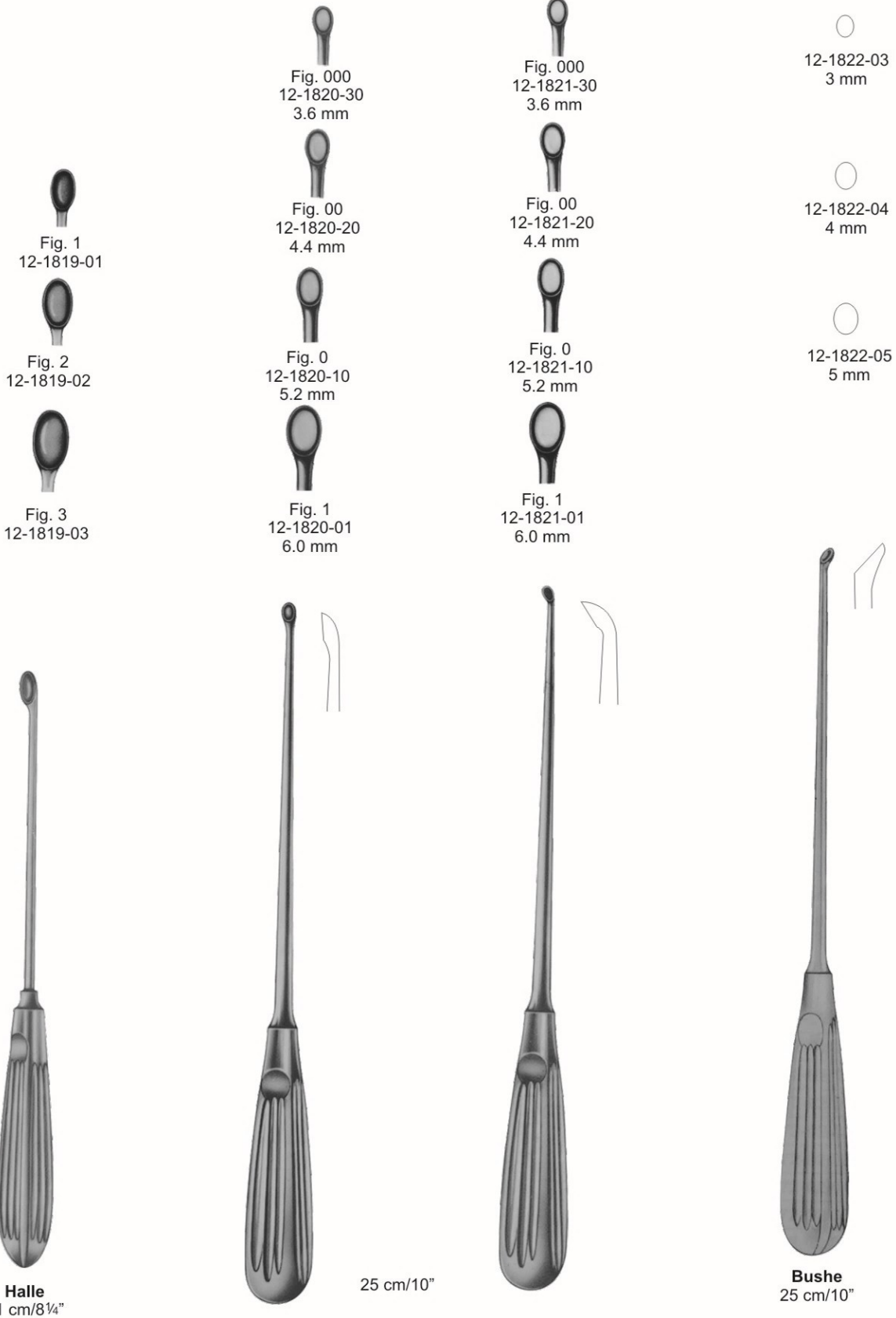

# Bone Instruments

Bone Curettes  
Scharfe Löffel

Curettes osseuses  
Curetas óseas



12-1823-21  
21 cm/8 1/4"



**Epstein**



**Spinal**



**Spinal**

Fig.

000	12-1824-30	12-1825-30	12-1826-30
00	12-1824-20	12-1825-20	12-1826-20
0	12-1824-10	12-1825-10	12-1826-10
1	12-1824-01	12-1825-01	12-1826-01
2	12-1824-02	12-1825-02	12-1826-02
3	12-1824-03	12-1825-03	12-1826-03
4	12-1824-04	12-1825-04	12-1826-04
5	12-1824-05	12-1825-05	12-1826-05
6	12-1824-06	12-1825-06	12-1826-06
	20 cm/8"	20 cm/8"	20 cm/8"

# Bone Instruments

Bone Curettes  
Scharfe Löffel

Curettes osseuses  
Curetetas óseas

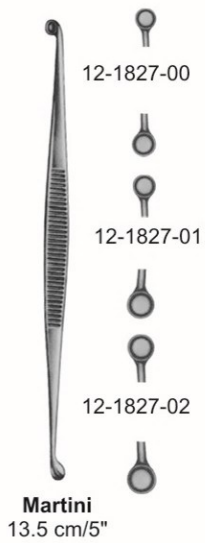

Length	Volkman	
	Oval/Oval	Oval/Round
13 5"	12-1829-13	12-1830-13
14 5½"	12-1829-14	
16 6¼"		12-1830-16
17 6¾"	12-1829-17	
20 8"	12-1829-20	12-1830-20



# Bone Instruments

Bone Files and Rasps

Knochen-Feilen und Raspeln

Fichiers os et râpes

Archivos de hueso y Escofinas

**Accu-Med**<sup>®</sup>  
Instrument Co.



**Putti**  
12-1836-30  
30 cm/12"



**Putti**  
12-1837-27  
27 cm/10½"



12-1838-25  
25 cm/10"



12-1839-24  
24 cm/9½"



12-1840-22  
22 cm/8¾"



## Bone Instruments

Periosteal Raspatories  
periostale Raspatories

périostée Couronne Instruments  
Raspatories periostio



**Farabeuf-Collin**  
12-1841-15  
15.5 cm/6"  
11 mm



**Farabeuf-Collin**  
12-1842-15  
15.5 cm/6"  
11 mm



**Farabeuf**  
12-1843-15  
15 cm/6"



**Farabeuf**  
12-1844-15  
15 cm/6"

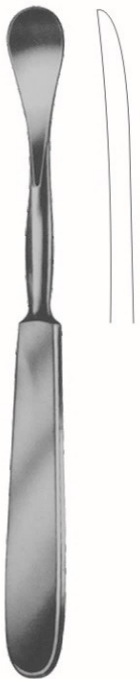

**Sedillot**  
12-1845-18  
18 cm/7"  
18 mm



**Sedillot**  
12-1846-21  
21 cm/8<sup>3</sup>/<sub>4</sub>"  
15 mm



**Langenbeck**  
12-1847-18  
18 cm/7"



**Langenbeck**  
12-1848-19  
19 cm/7<sup>1</sup>/<sub>2</sub>"

# Bone Instruments

Periosteal Raspatories  
periostale Raspatories

périostée Couronne Instruments  
Raspatories periostio



**Alexander**  
12-1849-20  
20 cm/8"



**Lambotte**  
21 cm/8¼"

	mm
12-1850-05	05
12-1850-10	10
12-1850-15	15
12-1850-20	20
12-1850-25	25



**Schneider**  
12-1851-17  
17.5 cm/7"  
13 mm



**Schneider-Sauerbruch**  
12-1852-19  
19 cm/7½"  
13 mm



**Jansen**  
12-1853-16  
16.5 cm/6½"  
15 mm



**Seldin**  
12-1854-19  
19 cm/7½"



**Davidson-Alexander**  
12-1855-29  
29 cm/11½"



**Williger**  
12-1856-13  
13 cm/5"

# Bone Instruments

Periosteal Raspatories  
periostale Raspatories

périostée Couronne Instruments  
Raspatories periostio

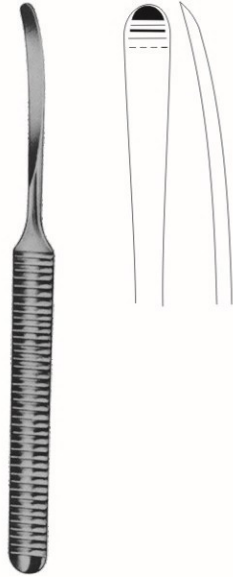

**Williger**  
12-1857-16  
16 cm/6¼"

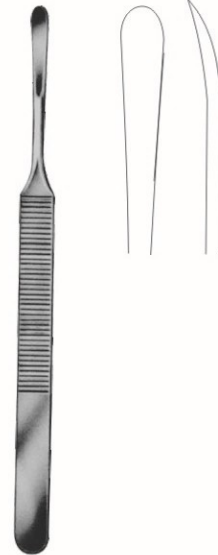

**Konig**  
12-1858-15  
15.5 cm/6"  
5 mm

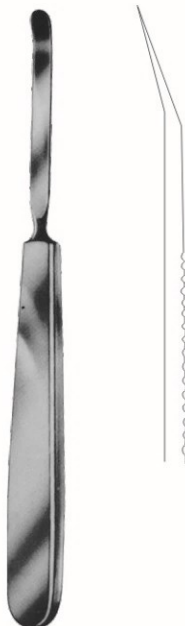

12-1859-06  
6 mm

17 cm/6¾"

12-1860-08  
8 mm



12-1861-01

12-1861-02

12-1861-03

12-1861-04

**Adson**  
17 cm/6¾"

# Bone Instruments

Periosteal Raspatories  
periostale Raspatories

périostée Couronne Instruments  
Raspatories periostio



**Matson**  
12-1863-22  
22 cm/8¾"



**Overholt**  
12-1864-29  
29.5 cm/11½"



**Overholt**  
12-1865-29  
29.5 cm/11½"



**Overholt**  
12-1866-28  
28.5 cm/11¼"

# Bone Instruments

Periosteal Raspatories  
periostale Raspatories

périostée Couronne Instruments  
Raspatories periostio

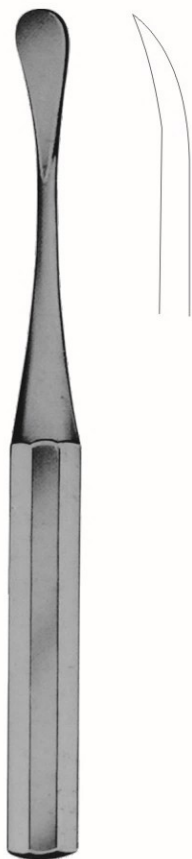

**Cobb**  
24 cm/9½"



12-1867-04  
4 mm



12-1867-06  
6 mm



12-1867-08  
8 mm



12-1867-10  
10 mm



12-1867-13  
13 mm



12-1867-19  
19 mm

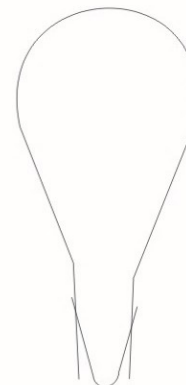

12-1867-25  
25 mm

# Bone Instruments

Periosteal Raspatories  
periostale Raspatories

périostée Couronne Instruments  
Raspatories periostio



**Doyen**  
17 cm/6¾"

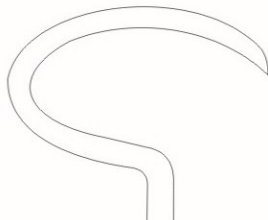

12-1868-01

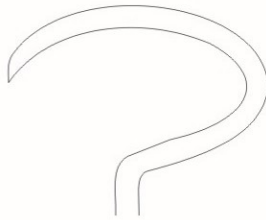

12-1868-02

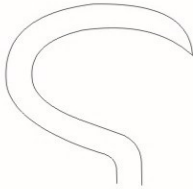

12-1869-01



12-1869-02



12-1870-01



**Doyen**  
24 cm/9½"



12-1871-02



**Semb**



12-1872-01  
19.5 cm/7½"  
12 mm



12-1872-02  
19.5 cm/7½"  
12 mm



12-1872-03  
19.5 cm/7½"  
12 mm



12-1872-04  
22 cm/8¾"  
13 mm



12-1872-05  
21.5 cm/8½"  
13 mm



12-1872-06  
22 cm/8½"  
15 mm



12-1872-07  
22 cm/8½"  
15 mm

# Bone Instruments

Periosteal Raspatories  
periostale Raspatories

périostée Couronne Instruments  
Raspatories periostio



12-1873-05  
18.5 cm/7¼"  
13 mm



12-1874-06  
19.5 cm/7¾"  
14 mm



12-1875-07  
18.5 cm/7¼"  
14 mm



12-1876-08  
20 cm/8 "  
20 mm



12-1877-01  
19 cm/7½"  
6 mm



12-1878-02  
18.5 cm/7¼"  
3 mm



12-1879-03  
18.5 cm/7¼"  
6 mm



12-1880-04  
18.5 cm/7¼"  
6 mm

# Bone Instruments

Periosteal Raspatories  
periostale Raspatories

périostée Couronne Instruments  
Raspatories periostio



12-1881-20  
27.5 cm/10¾"  
20 mm



**Wagner**  
8 mm 12-1882-08 33 cm/13"  
17 mm 12-1882-17 33 cm/13"



**Cobb**  
10 mm 12-1883-10 25 cm/10"  
13 mm 12-1883-13 25 cm/10"  
19 mm 12-1883-19 25 cm/10"  
25 mm 12-1883-25 25 cm/10"



**Cobb**  
10 mm 12-1884-10 28 cm/11"  
13 mm 12-1884-13 28 cm/11"  
19 mm 12-1884-19 28 cm/11"

# Bone Instruments

Elevators  
Aufzüge

Ascenseurs  
Ascensores



**Langenbeck**  
12-1885-20  
20 cm/8"  
8 mm



**Langenbeck**  
12-1886-20  
20 cm/8"  
10 mm

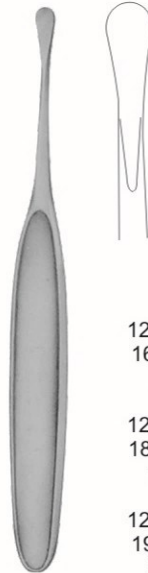

12-1887-07  
16 cm/6¼"  
7 mm

12-1887-15  
18.5 cm/7¼"  
15 mm

12-1887-20  
19 cm/7½"  
20 mm



**Yankauer**  
12-1888-18  
18 cm/7"



**Langenbeck**  
12-1889-23  
23 cm/9"  
11 mm



**Williger**  
12-1890-16  
16 cm/6¼"



**Williger**  
12-1891-17  
17 cm/6¾"

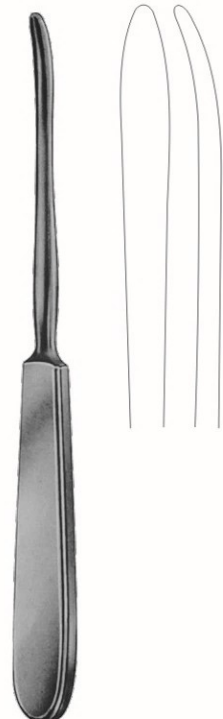

**Quervain**  
12-1892-20  
20 cm/8"

# Bone Instruments

Elevators  
Aufzüge

Ascenseurs  
Ascensores

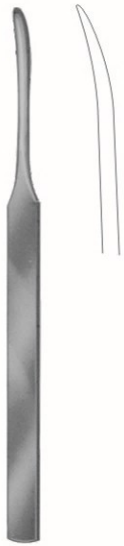

**König**  
12-1893-15  
15 cm/6"  
4.5 mm



**König**  
12-1894-15  
15 cm/6"  
4.5 mm



**Hohman-Willinger**  
12-1895-16  
16 cm/6¼"



6 mm



12 mm

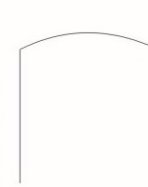

19 mm

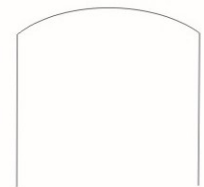

25 mm

**Key**

6 mm	12-1896-06	19 cm/7½"
12 mm	12-1896-12	19 cm/7½"
19 mm	12-1896-19	19 cm/7½"
25 mm	12-1896-25	19 cm/7½"

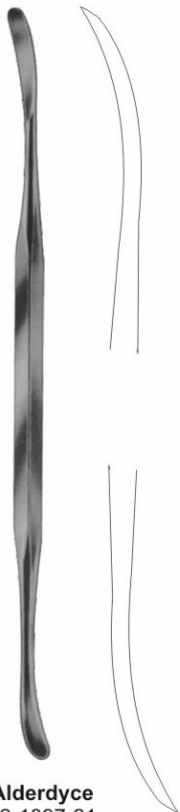

**Alderdyce**  
12-1897-21  
21 cm/8¼"



**McDonald**  
12-1898-19  
19 cm/7½"



**Watson-Cheyne**  
12-1899-19  
17.5 cm/7"



**Sebileau**  
12-1900-17  
17 cm/6¾"

# Bone Instruments

Bone Levers  
Knochen-Hebel

Leviers os  
Las palancas de hueso

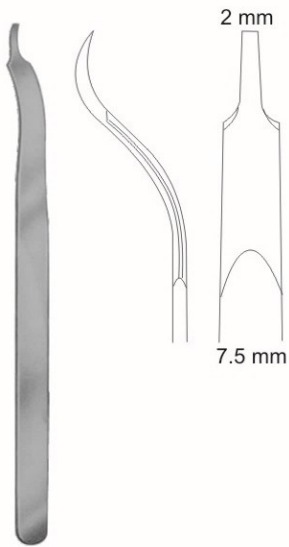

**Buck-Gramcko**  
12-1901-15  
15 cm/6"



**Hohmann mini**  
12-1902-14  
14 cm/5½"  
2.8 mm



12-1903-15  
15 cm/6"  
5 mm



12-1904-15  
15 cm/6"  
7 mm

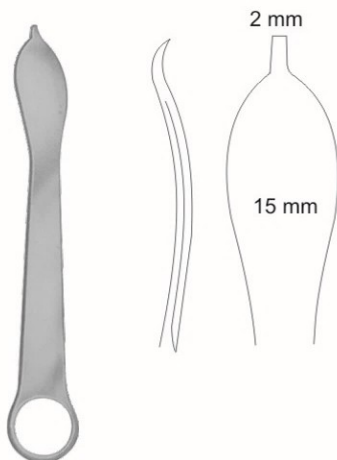

12-1905-12  
12.5 cm/5"

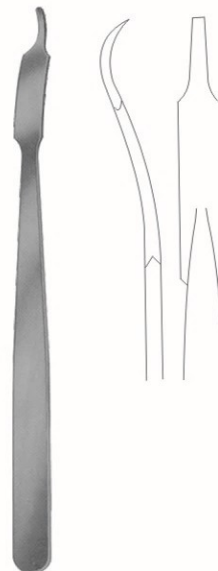

**Mini-Hohmann** 12-1906-06  
16 cm/6¼"  
6 mm



12-1906-08  
8 mm

# Bone Instruments

Bone Levers  
Knochen-Hebel

Leviers os  
Las palancas de hueso



12-1907-26  
26.5 cm/10½"  
24 mm



**Lange-Hohmann**  
12-1908-26  
26 cm/10¼"  
22 mm



**Hohmann**  
12-1909-22  
22 cm/8¾"  
8 mm



**Hohmann**  
24 cm/9½"

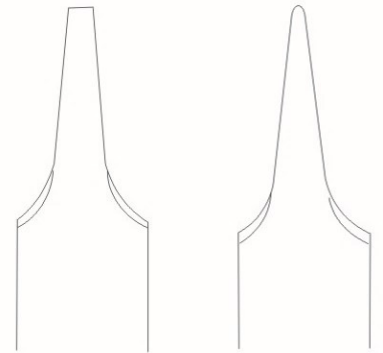

12-1910-17 17 mm  
12-1910-18 18 mm

12-1911-17 17 mm

## Bone Instruments

Bone Levers  
Knochen-Hebel

Leviers os  
Las palancas de hueso



**Hohmann**  
12-1912-26  
26 cm/10¼"  
22 mm

**Hohmann**  
12-1913-28  
28 cm/11"  
33 mm

**Hohmann**  
12-1914-24  
24 cm/9½"  
43 mm

**Hohmann**  
12-1915-24  
24.5 cm/9¾"  
43 mm

**Hohmann**  
12-1916-24  
24 cm/9½"  
70 mm

**Hohmann**  
12-1917-22  
22 cm/8¾"  
18 mm

# Bone Instruments

Bone Levers  
Knochen-Hebel

Leviers os  
Las palancas de hueso



**Lange-Hohmann modif**  
30 mm 12-1918-26 26.5 cm/10 1/2"  
33 mm 12-1918-29 29.0 cm/11 1/2"



**Hohmann-Aldinger**  
12-1919-27  
27 cm/10 1/2"

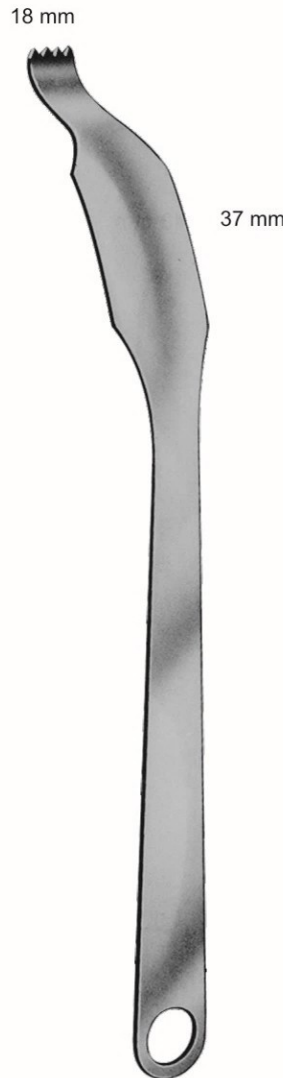

**Schumacher**  
(Wagner)  
12-1920-34  
34.5 cm/13 1/2"

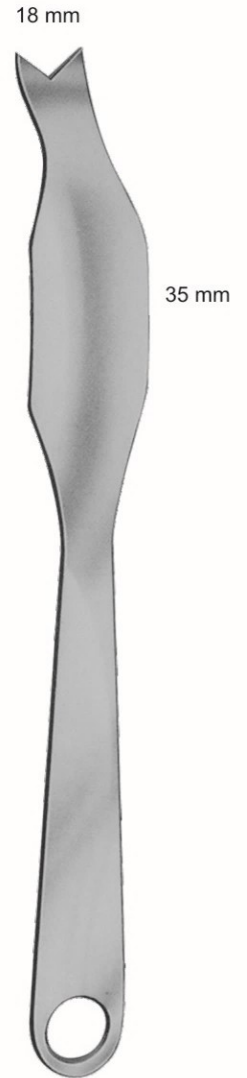

**Schumacher**  
12-1921-29  
29 cm/11 1/2"

## Bone Instruments

Bone Levers  
Knochen-Hebel

Leviers os  
Las palancas de hueso

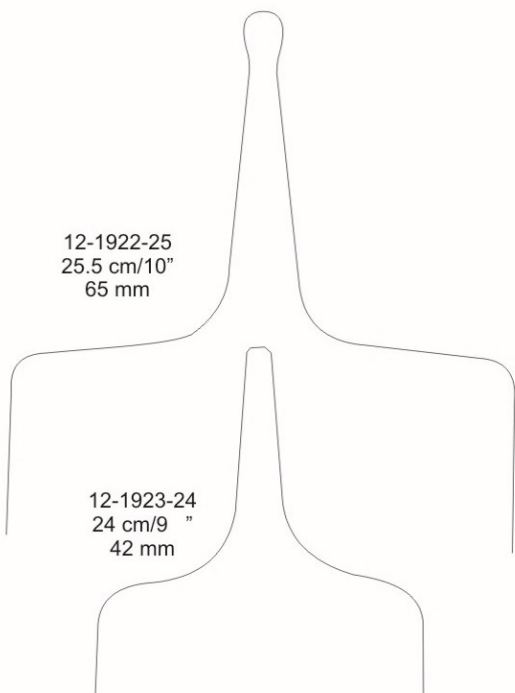

12-1922-25  
25.5 cm/10"  
65 mm

12-1923-24  
24 cm/9"  
42 mm



**Verbrugge-Muller**



**Lane Trethowan**  
12-1927-21  
21.5 cm/8½"



**Lane**  
12-1925-25  
25.5 cm/10"



**Bristow**  
12-1926-23  
23 cm/9"

# Bone Instruments

Bone Levers  
Knochen-Hebel

Leviers os  
Las palancas de hueso



**Blount**  
12-1928-26  
26 cm/10¼"



**Blount**  
12-1929-26  
26 cm/10¼"



**Bennett** 12-1930-43 43 mm  
24 cm/9½" 12-1930-60 60 mm



**Murphy-Lane**  
12-1931-32  
32 cm/12½"



**Chandler**

Length Länge longueur longitud	Width Breite largeur ancho	
18 cm	13 mm	12-1932-13
20 cm	19 mm	12-1932-19
23 cm	25 mm	12-1932-23
25 cm	30 mm	12-1932-30

## Bone Instruments

Meniscus and Spinal Retractors  
Meniskus-und Spinal Retraktoren

Rétracteurs méniscales et de la moelle  
Los retractoros de menisco y la columna vertebral



**Smillie**  
14 cm/5½"



12-1933-04  
52x13 mm



12-1933-05  
12x13 mm

12-1933-01  
32x19 mm

12-1933-02  
48x19 mm

12-1933-03  
57x19 mm

Spinal retractors  
Spinal Retraktoren  
écarteurs rachidiens  
retractoros de la columna vertebral



12-1934-01  
75x30 mm  
12-1934-02  
100x30 mm

**Taylor**  
17 cm/6½"

Meniscus retractors  
Meniskus Retraktoren  
rétracteurs de ménisque  
retractoros de menisco



12-1935-21  
21.5 cm/8½"



**Blount**  
12-1936-17  
17.5 cm/7"

# Bone Instruments

Meniscotomy Knives  
Meniscotomy Messer

Couteaux Meniscotomy  
Cuchillos Meniscotomy



**Smillie**  
12-1937-17  
17 cm/6¾"



**Smillie**  
12-1938-17  
17 cm/6¾"

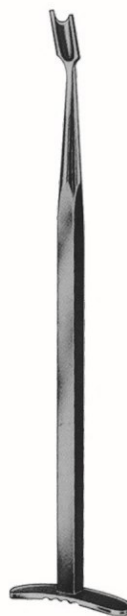

**Smillie**  
12-1939-17  
17 cm/6¾"



**Salenius**  
12-1940-22  
22 cm/8¾"



**Salenius**  
12-1941-22  
22 cm/8¾"

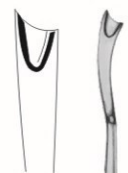

12-1942-17  
17.5 cm/7"



**Neff**  
12-1943-01  
21.5 cm/8½"



**Canad-Modell**  
12-1943-01  
20 cm/8"



12-1944-02



**Bircher**  
12-1945-20  
20.5 cm/8"

## Bone Instruments

Bone Holding Forceps  
Knochenhaltezen

Os Davier  
Bone Pinzas



**Dingmann Modif**  
12-1946-19  
19 cm/7½"



**Dingmann**  
12-1947-19  
19cm/7½"



**Neff ¼**  
12-1948-21  
21cm/8 "



12-1949-20  
20 cm/8"  
Straight  
gerade  
droit  
recto

12-1950-20  
20 cm/8"  
Curved on Falt  
Gebogene am Falt  
Courbé sur Falt  
Curva de Falt



**Van Buren**  
12-1951-23  
23 cm/9"

# Bone Instruments

Bone Holding Forceps  
Knochenhaltezaugen

Os Davier  
Bone Pinzas

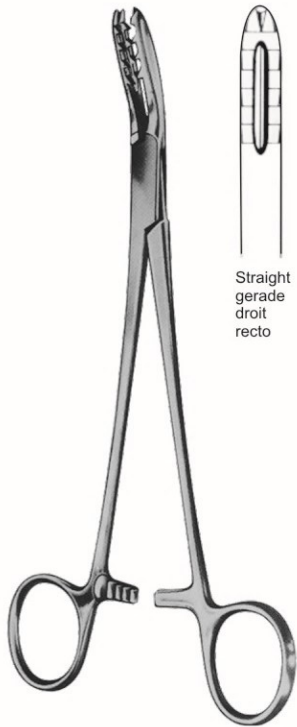

**Bircher-Ganske**  
12-1952-20  
20 cm/8"

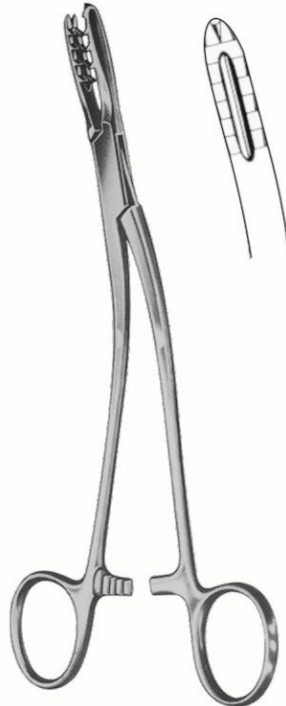

**Bircher-Ganske**  
12-1953-20  
20 cm/8"



**Martin**  
12-1954-19  
19 cm/7½"



**Lewin**  
12-1955-17  
17.5 cm/7"



**Fergusson**  
12-1956-21  
21 cm/8¼"



**Langenbeck**  
12-1957-21  
21 cm/8¼"

# Bone Instruments

Bone Holding Forceps  
Knochenhaltezaugen

Os Davier  
Bone Pinzas



Without Ratchet  
ohne Ratchet  
sans cliquet  
Sin Ratchet

12-1958-17  
12-1958-21

**Kern**

cm	in
17	6¾"
21	8¼"

With Ratchet  
mit Ratchet  
avec Ratchet  
Con Ratchet

12-1959-17  
12-1959-21

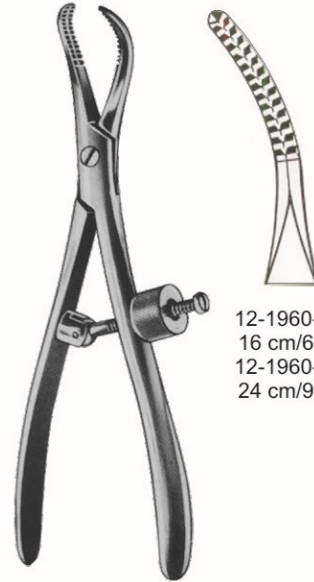

12-1960-16  
16 cm/6¼"  
12-1960-24  
24 cm/9½"



**Ulrich**  
12-1961-18 18 cm/7"  
12-1961-23 23 cm/9"  
12-1961-25 25 cm/10"  
12-1961-28 28 cm/11"



**Ulrich**  
12-1962-18 18 cm/7"  
12-1962-23 23 cm/9"  
12-1962-25 25 cm/10"  
12-1962-28 28 cm/11"



**Hey Groves**  
12-1963-21 20 cm/8"  
12-1963-27 25 cm/10"  
12-1963-30 30 cm/12"

# Bone Instruments

Bone Holding Forceps  
Knochenhaltezangen

Os Davier  
Bone Pinzas



**Semb**  
12-1964-19  
19 cm/7½"



**Semb**  
12-1965-19  
19 cm/7½"



**Verbrugge**  
12-1966-17  
17.5 cm/7"



**Verbrugge**

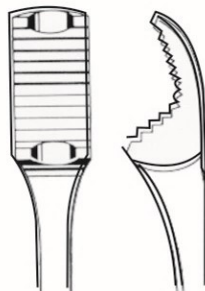

12-1967-25  
25 cm/10"

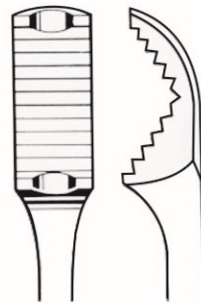

12-1968-26  
26 cm/10¼"  
**Verbrugge**

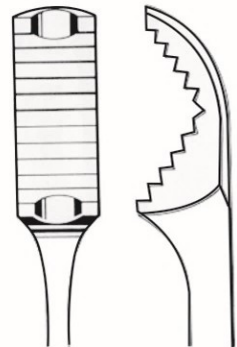

12-1969-27  
27 cm/10½"

## Bone Instruments

Bone Holding Forceps  
Knochenhaltezaugen

Os Davier  
Bone Pinzas



**Self  
Centring**

12-1970-15 15 cm/6"  
12-1970-19 19 cm/7½"  
12-1970-24 24 cm/9½"  
12-1970-26 26 cm/10¼"  
12-1970-28 28 cm/11"

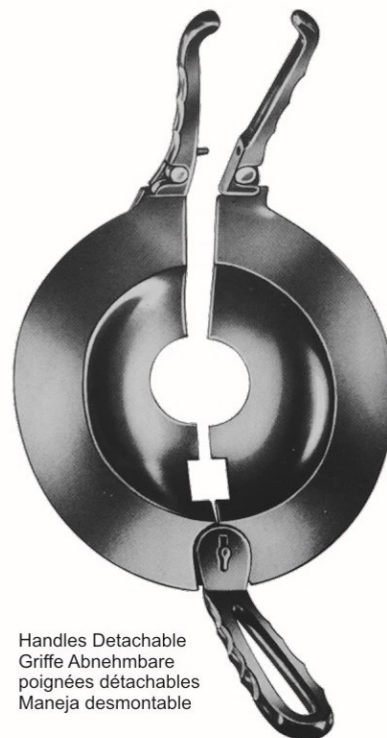

Handles Detachable  
Griffe Abnehmbare  
poignées détachables  
Maneja desmontable

**Percy**  
12-1971-30

Adjustable  
einstellbar  
réglable  
ajustable



**Lambotte**

12-1972-22 22 cm/8¾"  
12-1972-27 27 cm/10½"  
12-1972-30 30 cm/12"



**Farabeuf**

12-1973-23 23 cm/9"  
12-1973-26 26 cm/10¼"



**Lambotte**

12-1974-22 22.5 cm/9"  
12-1974-25 25.5 cm/10½"  
12-1974-33 33 cm/13½"

# Bone Instruments

Bone Holding Forceps  
Knochenhaltezangen

Os Davier  
Bone Pinzas



**Farabeuf-Lambotte**  
12-1975-26  
26 cm/10¼"



**Lambotte**  
12-1976-19 19 cm/7½"  
12-1976-23 23 cm/9"  
12-1976-26 26 cm/10¼"

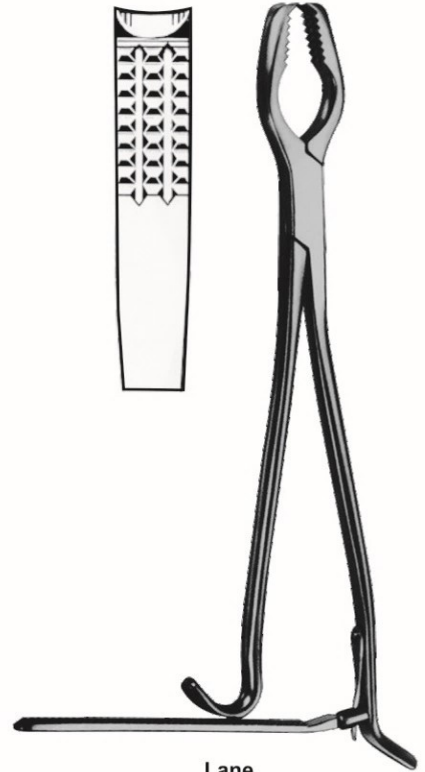

	<b>Lane</b>	
	cm in	
12-1977-33	33 13"	12-1978-33
12-1977-45	45 17¾"	12-1978-45
Without Ratchet ohne Ratchet sans cliquet Sin Ratchet		With Ratchet mit Ratchet avec Ratchet Con Ratchet



12-1979-14  
14.5 cm/5¾"



12-1980-12  
12 cm/4¾"



12-1981-13  
13.5 cm/5¼"

## Bone Instruments

Bone Holding Forceps and Bone Holding Clamps  
Knochenhaltezange and Bone Halteklammern

Os Davier et os Pincas de portefeuille  
Hueso y huesos Pinzas abrazaderas que sujetan



12-1982-20  
20 cm/8"



12-1983-17  
17 cm/6¾"



12-1984-17  
17.5 cm/7"

Traction Bar  
Traktion Bar  
barre de traction  
tracción Bar



**Lowman-Hoglund**  
12-1985-19  
19 cm/7½"



**Lowman**  
12-1986-18 18 cm/7"  
12-1986-20 20 cm/8"  
12-1986-22 22 cm/8¾"



**Lowman**  
12-1987-12  
12 cm/4¾"

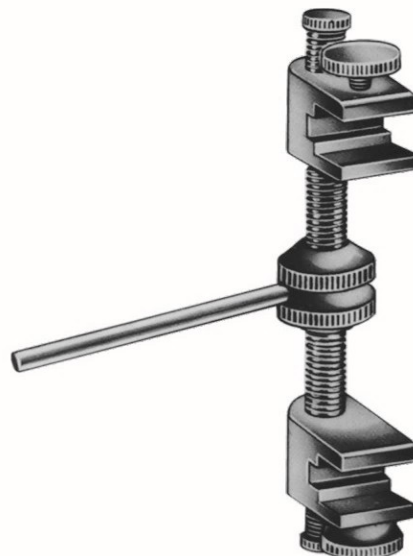

**Gerster**  
12-1988-18  
12-1988-50

# Bone Instruments

Bone Rongeur Forceps  
Knochen Hohlmeißelzange

Os Rongeur Forceps  
Pinzas gubia ósea



**Clovis Vincent**  
12-1989-21 21 cm/8 1/4"  
12-1989-26 26 cm/10 1/4"



**Bane-Hartmann**  
12-1990-17  
17.5 cm/7"



**Mini-Friedmann**  
12-1991-12  
12.5 cm/5"



**Friedmann**  
12-1992-14  
14 cm/5 1/2"

## Bone Instruments

Bone Rongeur Forceps  
Knochen Hohlmeißelzange

Os Rongeur Forceps  
Pinzas gubia ósea



**Friedmann-Delicate**  
15 cm/6"



12-1993-15



90°

12-1993-90



**Bacon**  
12-1994-20  
20 cm/8"



**Hartmann**  
12-1995-18  
18.5 cm/7 1/4"



**Cleveland**  
12-1996-14 14 cm/5 1/2"  
12-1996-17 17 cm/6 3/4"



**Olivecrona**  
12-1997-20  
20 cm/8"

# Bone Instruments

Bone Rongeur Forceps  
Knochen Hohlmeißelzange

Os Rongeur Forceps  
Pinzas gubia ósea



**Lempert**

12-1998-16	cm	in	12-1999-16
12-1998-19	16	6¼"	12-1999-19
	19	7½"	
Straight			Curved
gerade			Gebogene
droit			courbé
recto			Curvo



**Beyer**

12-2000-18  
18 cm/7"



**Mead**

16.5 cm/6½"



12-2001-16



12-2002-16



**Blumenthal**  
15.5 cm/6"



12-2003-15



12-2004-15



12-2005-15



**Hakansson**  
12-2006-15  
15.5 cm/6"



**Jansen**  
18 cm/7"



12-2007-17



12-2008-17

## Bone Instruments

Bone Rongeur Forceps  
Knochen Hohlmeißelzange

Os Rongeur Forceps  
Pinzas gubia ósea



12-2009-22

Straight  
gerade  
droit  
recto



12-2010-22

Curved  
Gebogene  
courbé  
Curvo

**Stille-Luer**  
22 cm/8¾"



12-2011-27



12-2012-27

**Stille-Luer**  
27 cm/10½"



**Semb**  
12-2013-23  
23 cm/9"

# Bone Instruments

Bone Rongeur Forceps  
Knochen Hohlmeißelzange

Os Rongeur Forceps  
Pinzas gubia ósea



**Jansen**  
12-2014-18  
18 cm/7"



**Luer**  
17 cm/6¾"

12-2015-17  
Straight  
gerade  
droit  
recto

12-2016-17  
Curved  
Gebogene  
courbé  
Curvo



Heavy Pattern  
schwere Pattern  
modèle lourd  
patrón pesado

**Luer**  
18.5 cm/7¼"  
12-2017-15



**Luer**  
15 cm/6"

12-2018-15

12-2019-15

12-2020-15



**Adson**  
20 cm/8"

12-2021-20

# Bone Instruments

Bone Rongeur Forceps  
Knochen Hohlmeißelzange

Os Rongeur Forceps  
Pinzas gubia ósea



**Bohler**  
15cm/6"

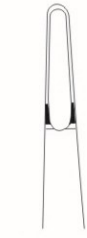

12-2022-15



12-2023-15



**Kleinert-Kutz**  
15cm/6"



12-2024-15  
2mm



12-2025-15  
3mm



**Beyer  
Zaufal-Jansen**  
18 cm/7"



**Zaufal-Jansen**  
12-2026-18



**Beyer**  
12-2027-18



**Mayfield**  
12-2028-17  
17 cm/6 3/4"



**Ruskin**  
12-2029-18  
18 cm/7"

Straight  
gerade  
droit  
recto  
12-2030-18  
18 cm/7"  
12-2030-23  
23 cm/9"



**Ruskin**



Straight  
gerade  
droit  
recto  
12-2031-18  
18 cm/7"  
12-2031-23  
23 cm/9"

# Bone Instruments

Bone Rongeur Forceps  
Knochen Hohlmeißelzange

Os Rongeur Forceps  
Pinzas gubia ósea



**Marquardt**  
12-2032-20  
20 cm/8"



12-2034-03  
3 mm



12-2034-04  
4 mm



12-2034-05  
5 mm



12-2035-03  
3 mm



12-2035-04  
4 mm



12-2035-05  
5 mm



**Rottgen-Ruskin**  
12-2033-24  
24 cm/9½"



**Smith-Petersen**  
24 cm/9½"

# Bone Instruments

Bone Rongeur Forceps  
Knochen Hohlmeißelzange

Os Rongeur Forceps  
Pinzas gubia ósea



**Stille-Ruskin**  
12-2036-23  
23 cm/9"



**Echlin**  
23 cm/9"

12-2037-02  
2 mm

12-2037-03  
3 mm

12-2037-04  
4 mm



**Leksell**  
23 cm/9"



12-2038-03  
3 mm

12-2038-04  
4 mm

12-2038-06  
6 mm

12-2038-08  
8 mm



**Frykholm**  
12-2039-23  
23 cm/9"



**Stille**  
12-2040-23  
23 cm/9"



**Sauerbruch**  
30 cm/12"



12-2041-30



12-2042-30

# Bone Instruments

Bone Cutting Forceps  
Knochensplitterzangen

Pince de coupe d'os  
Pince de coupe d'os...



**Markwalder**  
12-2043-20 20 cm/8"



12-2044-14 14  
12-2044-17 17  
12-2044-19 19  
12-2044-22 22

Straight  
gerade  
droit  
recto

cm **Liston** in  
5½  
6¾  
7½  
8¾



12-2045-14  
12-2045-17  
12-2045-19  
12-2045-22

Curved  
Gebogene  
courbé  
Curvo



**Littauer-Liston**  
12-2046-15  
15 cm/6"



**Cleveland**  
12-2047-15 15 cm/6"  
12-2047-17 17 cm/6¾"



**Bohler**  
15 cm/6"

12-2048-15  
Straight  
gerade  
droit  
recto

12-2049-15  
Curved on flat  
Gebogene auf flachen  
Courbé sur le plat  
Curva plana en



**McIndoe**  
12-2050-17  
17.5 cm/7"

# Bone Instruments

Bone Cutting Forceps  
Knochensplitterzangen

Pince de coupe d'os  
Pince de coupe d'os...



**Liston-Key (Horsley)**  
12-2051-27  
27 cm/10½"



**Semb**  
12-2052-27-24  
24 cm/9½"



**Kazanjian**  
12-2053-27-18  
18 cm/7"



**Ruskin-Liston**  
18.5 cm/7¼"

12-2054-18  
Straight  
gerade  
droit  
recto



12-2055-18  
Curved on flat  
Gebogene auf flachen  
Courbé sur le plat  
Curva plana en



**Stille-Liston**  
23 cm/9"  
27 cm/10½"

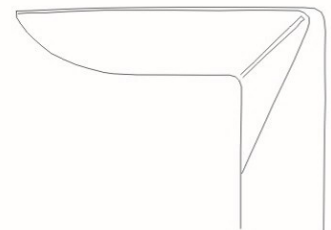

15-1061-27  
27 cm/10½"

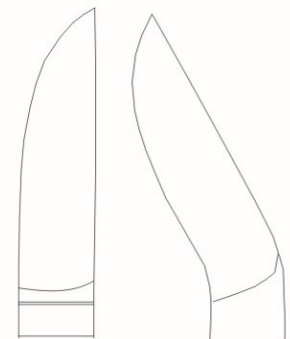

12-2056-23  
12-2056-27  
12-2057-23  
12-2057-27

# Bone Instruments

Nail Instruments and Finger Ring Cutters  
Nail Instruments und Fingerring Schneider

Nail Instruments et couteaux pour bagues  
Instrumentos y cortadores de uñas del dedo del anillo



12-2058-13  
13.5 cm/5"



18 cm/7"



12-2059-18



12-2060-18



**Radolf**  
12-2061-13  
13.5 cm/5 1/4"



Saw blade  
Sägeblatt  
lame de scie  
hoja de sierra

12-2062-17  
17 cm/6 3/4"



Saw blade  
Sägeblatt  
lame de scie  
hoja de sierra

**Walton**  
12-2063-17  
17 cm/6 3/4"

## Bone Instruments

Amputation and Resection Saws  
Amputation und Resektion Sägen

Scies d'amputation et résection  
Amputación y resección Sierras



**Langenbeck**  
12-2064-23  
23 cm/9"



**Satterlee**  
12-2065-31  
31 cm/12¼"



**Charriere**  
12-2066-27 27 cm/10½"  
12-2066-30 30 cm/12"  
12-2066-34 34 cm/13½"

Spare saw blades  
Spare Sägeblätter  
Lames de scie de rechange  
Cuchillas de recambio sierra

12-2067-43 3 mm  
12-2067-45 5 mm  
12-2067-47 7 mm

Complete with 3 blades  
Komplett mit 3 Klingen  
Livré avec 3 lames  
Completo con 3 cuchillas  
12-2067-39



**Helferich-Bier**

Spare saw blades  
Spare Sägeblätter  
Lames de scie de rechange  
Cuchillas de recambio sierra

12-2068-12 12 mm  
12-2068-15 15 mm

Complete with 2 blades  
Komplett mit 2 Klingen  
Livré avec 2 lames  
Completo con 2 cuchillas  
12-2068-35



**Charriere**

# Bone Instruments

Bone Drills  
Bone Drills

Perceuses os  
Bone Drills

Accu-Med<sup>®</sup>  
Instrument Co.



**Adjustable handle**  
12-2069-28  
28cm/11"

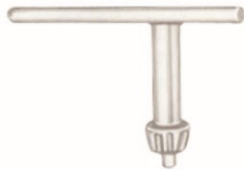

12-2070-11  
Key only  
Key nur  
seule clé  
clave única



**Ralk**  
12-2071-00  
accomodating up to 6.35mm Ø

# Bone Instruments

Bone Drills  
Bone Drills

Perceuses os  
Bone Drills



**Stille**  
12-2072-00



Fig. 1  
12-2072-01  
Ø 2,5mm



Fig. 2  
12-2072-02  
3,0mm



Fig. 3  
12-2072-03  
3,5mm



Fig. 4  
12-2072-04  
4,0mm



Fig. 5  
12-2072-05  
10,0mm



Fig. 6  
12-2072-06  
5,0mm



Fig. 7  
12-2072-07  
Ø8,0mm



Fig. 8  
12-2072-08  
12,0mm



Fig. 9  
12-2072-09  
16,0mm



**Hudson**  
12-2073-00  
27cm/10½"



Fig. 1  
12-2073-01  
Ø 9 mm



Fig. 2  
12-2073-02  
14mm

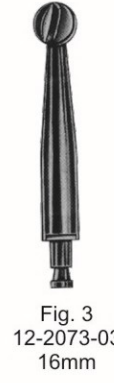

Fig. 3  
12-2073-03  
16mm



Fig. 4  
12-2073-04  
22mm



**Cushing**  
12-2073-05  
Ø14mm

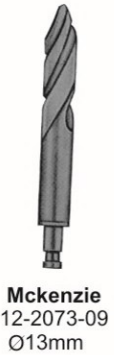

**Mckenzie**  
12-2073-09  
Ø13mm



12-2073-00

# Bone Instruments

Drill Guide and Dura Protecting Forceps  
Bohrerführung und Dura Schutz Zange

Guide-mèche et Pince Dura Protection  
Guía de broca y pinzas Dura Protección



**Adson**  
12-2074-15  
15 cm/6"

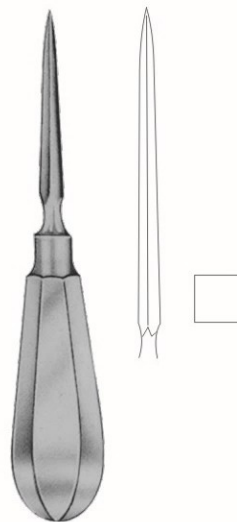

12-2075-14  
14 cm/5½"



12-2076-14  
14 cm/5½"

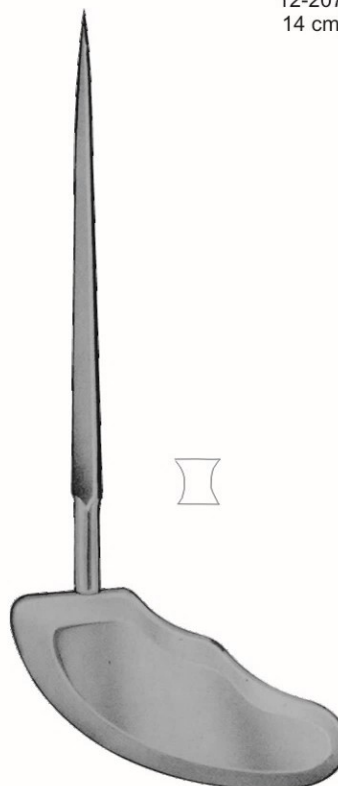

**Perthes**  
12-2077-21  
21 cm/8¼"

# Bone Instruments

Wire Seizing Forceps  
Draht Zange ergreifen

Pince fil Saisir  
Pinzas de alambre Aprovechar

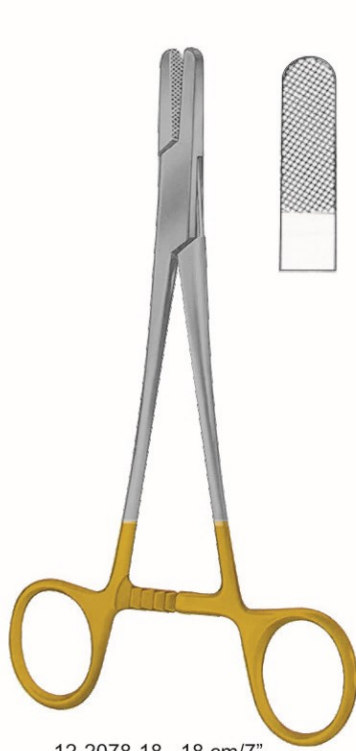

12-2078-18 18 cm/7"  
12-2078-20 20 cm/8"



12-2079-16  
15 cm/6"

12-2079-20  
20 cm/8"

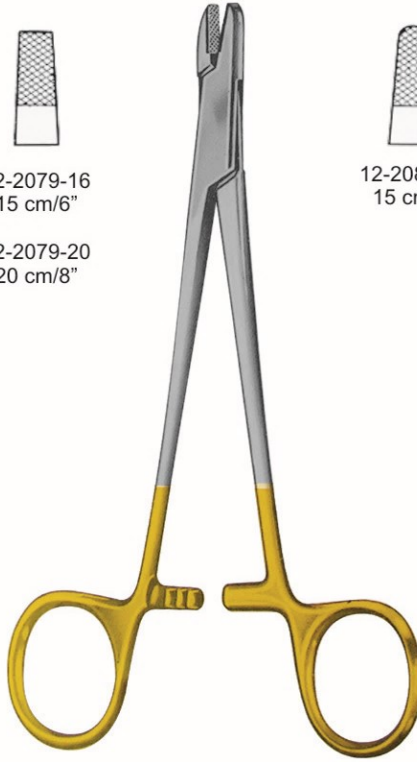

12-2080-16  
15 cm/6"



12-2081-14  
14 cm/5½"



12-2082-16  
16 cm/6¼"



18cm/7"



12-2083-01



12-2083-02



12-2083-03



12-2083-04

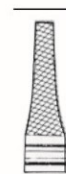

12-2083-05

# Bone Instruments

Wire Seizing Forceps  
Draht Zange ergreifen

Pince fil Saisir  
Pinzas de alambre Aprovechar



12-2084-15  
15.5 cm/6"

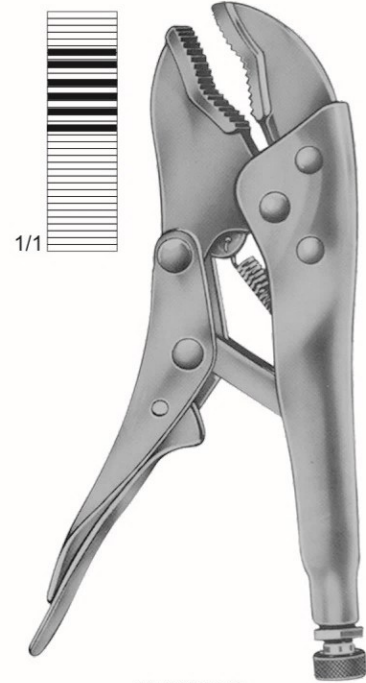

12-2085-18  
18 cm/7"



12-2086-13 13 cm/5"  
12-2086-18 18 cm/7"

## Bone Instruments

Wire Cutting Pliers  
Drahtschneidezangen

Pince coupante fil  
Alicates de corte de alambre

For soft wire  
with a diam. of max.  
For hard wire  
with a diam. of max.



12-2088-15  
24 cm/9 1/2"  
4.0 mm  
3.5 mm



12-2089-18  
18.5 cm/7 1/4"  
1.7 mm  
1.7 mm



2.0 mm  
1.5 mm  
12-2090-15  
15 cm/6"



2.0 mm  
2.0 mm  
12-2091-16  
16 cm/6 1/4"

# Bone Instruments

Wire Cutting Pliers  
Drahtschneidezangen

Pince coupante fil  
Alicates de corte de alambre



12-2092-12  
12 cm/4 3/4"

0.7 mm  
0.5 mm



12-2093-15  
15 cm/6"

2.0 mm  
1.0 mm



12-2094-18  
18 cm/7"

2.0 mm  
1.7 mm

## Bone Instruments

Wire Cutting Pliers  
Drahtschneidezangen

Pince coupante fil  
Alicates de corte de alambre



2.5 mm  
1.5 mm

12-2095-18  
18.5 cm/7 1/4"



2.0 mm 3.0 mm  
1.7 mm 2.5 mm

12-2096-18  
18 cm/7"

12-2097-22  
22 cm/8 3/4"



3.0 mm

12-2098-22  
22 cm/8 3/4"



7.5 mm

12-2099-47 47 cm/18 1/2"  
12-2099-57 57 cm/22 1/2"

# Bone Instruments

Extension Bows  
Erweiterung Bögen

Arcs d'extension  
Arcos de extensión

with 3 traction hooks  
mit 3 Traktion Haken  
avec 3 crochets de traction  
con 3 ganchos de tracción

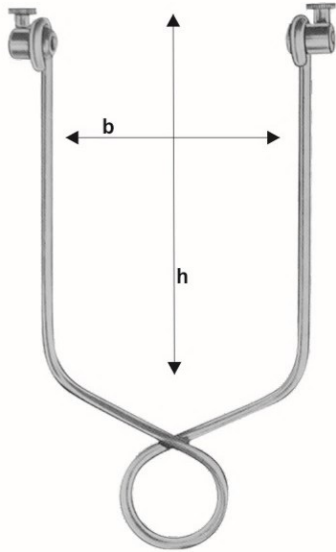

cm h x b	in h x b	
16 x 9	6 1/4 x 3 1/2	12-2100-16
21 X 11	8 1/4 X 4 1/2	12-2100-21
21 X 15	8" X 6"	12-2100-15



**Kirschner**

Clear width  
lichte Breite  
largeur libre  
anchura libre

	cm	In
12-2101-01	9,5x7	3 3/4 x 2 3/4
12-2101-02	10,5x10,5	4 1/4 x 4 1/4
12-2101-03	12x12	4 3/4 x 4 3/4
12-2101-04	15,5x15,5	6x6
12-2101-05	20x15,5	8x6

with 3 traction hooks  
mit 3 Traktion Haken  
avec 3 crochets de traction  
con 3 ganchos de tracción

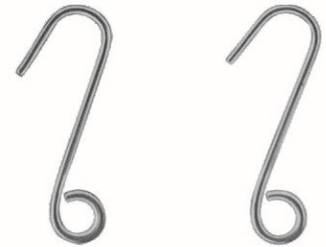

12-2104-40

12-2104-42



**Kirschner**

Clear width  
lichte Breite  
largeur libre  
anchura libre

12-2102-18	18x10	07x04
12-2102-27	27x16	10 1/2 x 6 1/4

cm	in
18x10	07x04
27x16	10 1/2 x 6 1/4



**Kirschner**

12-2103-01	Small Pattern
12-2103-02	Medium Pattern
12-2103-03	Large Pattern

Wire Strainer  
Draht Strainer  
Passoire fil  
Colador de alambre



12-2104-20

# Bone Instruments

Bone Wire, Twisting Instruments and Guides  
Knochen-Wire, Zwirn-Instrumente und Guides

Fil d'os, instruments de torsion et Guides  
Alambre de hueso, instrumentos giratorios y guías



Bone Wire Tighteners  
Knochen Draht Spanner  
Tendeurs Fils os  
Tensores de cables y Bone

**Loute**  
12-2105-21  
21 cm/8¼"

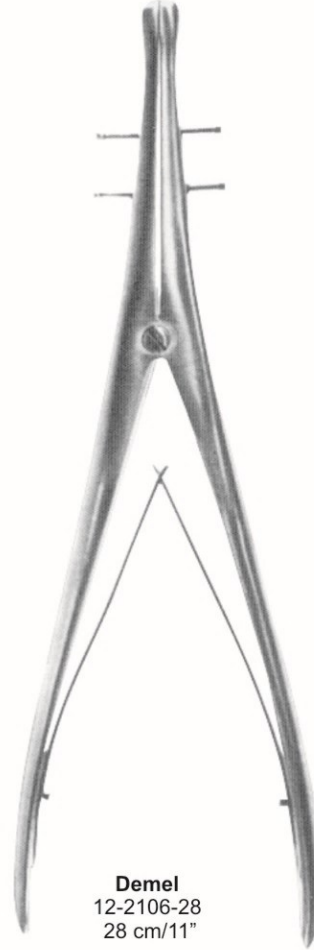

**Demel**  
12-2106-28  
28 cm/11"



**Demel**

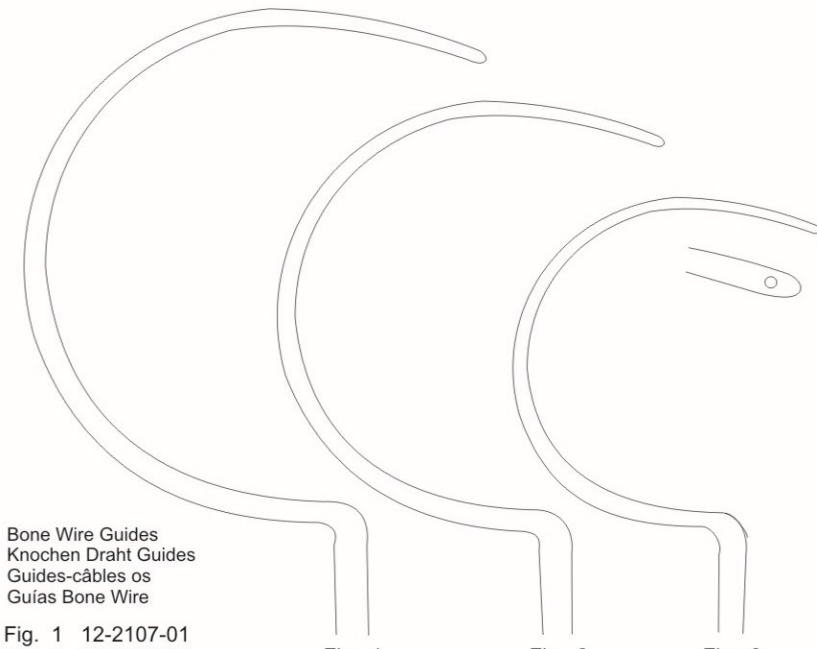

Bone Wire Guides  
Knochen Draht Guides  
Guides-cables os  
Guías Bone Wire

Fig. 1 12-2107-01  
Fig. 2 12-2107-02  
Fig. 3 12-2107-03

Fig. 1

Fig. 2

Fig. 3

# Bone Instruments

Bone Nail  
Knochen Nagel

Des clous à os  
Bone uñas



length **Schanz**

length	Ø 5 mm
8 cm	12-2108-08
10 cm	
12 cm	12-2108-12
14 cm	
15 cm	12-2108-15
16 cm	
17 cm	12-2108-17
18 cm	
20 cm	12-2108-20
22 cm	
25 cm	12-2108-25
30 cm	



with triangular end  
mit dreieckigem Ende  
avec extrémité triangulaire  
con extremo triangular



with trocar point  
mit Trokarspitze  
avec pointe trocart  
con punto de trocart

**Steinmann**

Length Länge longueur longitud	Ø 4 mm	Ø 4,5 mm	Ø 5 mm
8 cm	12-2109-08	12-2110-08	12-2111-08
10 cm	12-2109-10	12-2110-10	12-2111-10
12 cm	12-2109-12	12-2110-12	12-2111-12
14 cm	12-2109-14	12-2110-14	12-2111-14
15 cm			
16 cm	12-2109-16	12-2110-16	12-2111-16
17 cm			
18 cm	12-2109-18	12-2110-18	12-2111-18
20 cm	12-2109-20	12-2110-20	12-2111-20
22 cm	12-2109-22	12-2110-22	12-2111-22
25 cm	12-2109-25	12-2110-25	12-2111-25
30 cm	12-2109-30	12-2110-30	12-2111-30

# Bone Instruments

Mallets  
Mallets

Maillets  
mazos



22 cm/8 1/2"

300 g 12-2112-10  
500 g 12-2112-35  
600 g 12-2112-50  
940 g 12-2112-70



with interchangeable  
mit austauschbaren  
avec interchangeables  
intercambiable con

∅ 30 mm  
215 g

12-2113 -24  
24.5 cm/8 3/4"

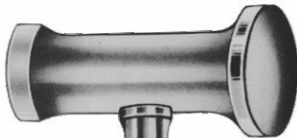

∅ 30 mm  
400 g

∅ 42 mm

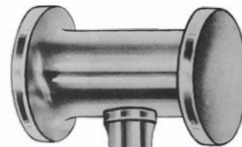

∅ 45 mm  
300 g



12-2114 -24  
24 cm/9 1/2"



**Bergmann**  
12-2115-24  
24 cm/9 1/2"

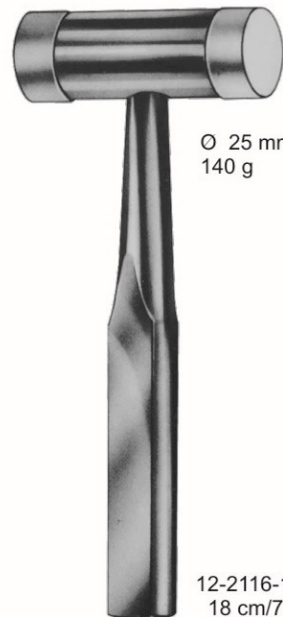

∅ 25 mm  
140 g

12-2116-18  
18 cm/7"

# Bone Instruments

Mallets  
Mallets

Maillets  
mazos



150 g



**Williger**  
12-2117-23  
23 cm/9"

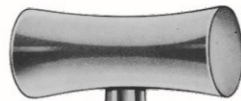

∅ 30 mm  
460 g



**Bergmann**  
12-2118-23  
23 cm/9"



1 Side Flat  
1 Side Convex



**Cottle**  
12-2119-19  
∅ 30 mm  
19 cm/7 1/2"  
350 g



∅ 42 mm  
400 g

∅ 42 mm  
250 g



12-2120-24  
24cm/9 1/2"



∅ 30 mm



**Ombredanne**  
12-2121-24  
23.5cm/9 1/4"

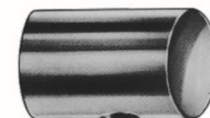

∅ 40 mm



**Heath**  
12-2122-18  
18 cm/7"

# Bone Instruments

Mallets  
Mallets

Maillets  
mazos

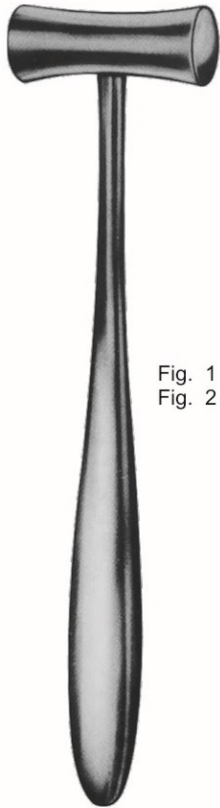
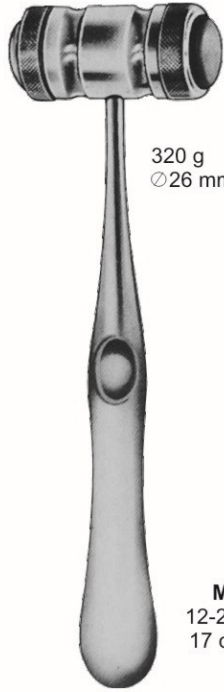

Fig. 1 12-2123-19 19mm O 230 g  
Fig. 2 12-2123-25 25mm O 260 g

**Lucae**  
19 cm/7½"



320 g  
Ø26 mm

**Mead**  
12-2124-17  
17 cm/6¾"



**Williger**  
12-2125-16  
16.5 cm/6½"



165 g  
Ø22 mm

12-2126-19  
19 cm/7½"



**Gerzog**  
12-2127-19  
19 cm/7½"



200 g  
22 mm Ø  
(7 oz.)

**Partsch**  
12-2128-18  
18 cm/7"

# Bone Instruments

Tendon Seizing Instruments  
Tendon ergriff Instruments

Tendon Instruments Saisir  
Aprovechar los instrumentos del tendón



**Fischer**  
12-2129-31  
31 cm/12¼"



12-2130-50  
50 cm/19½"  
6 mm Ø

**Brand**



12-2131-30  
30 cm/12"  
3 mm Ø



**Brand**  
12-2132-50  
50 cm/19½"

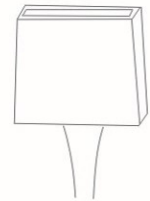

6 x 14 mm

Tendon Strippers  
Sehnen Strippers  
Décapants tendon  
Strippers tendón



mm Ø  
4.0 12-2133-40  
4.5 12-2133-45  
5.5 12-2133-55

Flexible Shaft  
flexible Welle  
arbre flexible  
eje flexible



**Steinmann**  
12-2134-50  
16 cm/6⅓"

# Bone Instruments

Tendon Seizing Instruments  
Tendon ergriff Instruments

Tendon Instruments Saisir  
Aprovechar los instrumentos del tendón



**Steinmann**  
12-2135-13  
13 cm/5"



12-2136-20

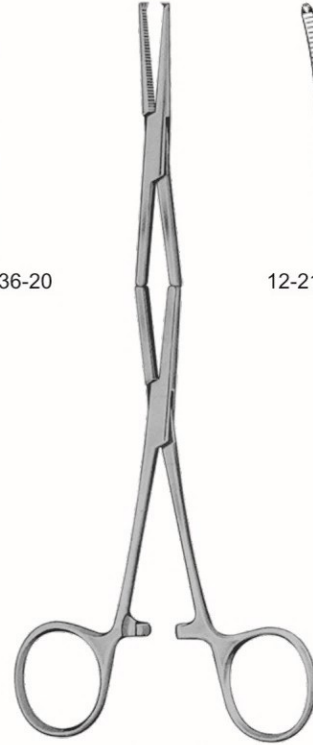

20 cm/8"



12-2137-20



**Caroll**  
12-2138-11  
11 cm/4½"

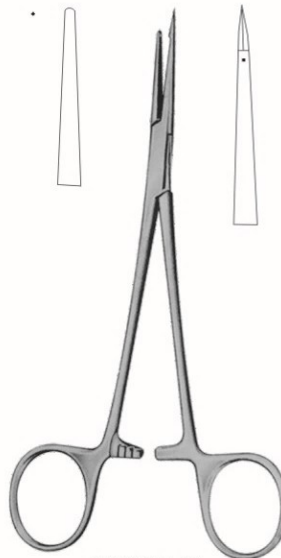

12-2139-15  
15 cm/6"

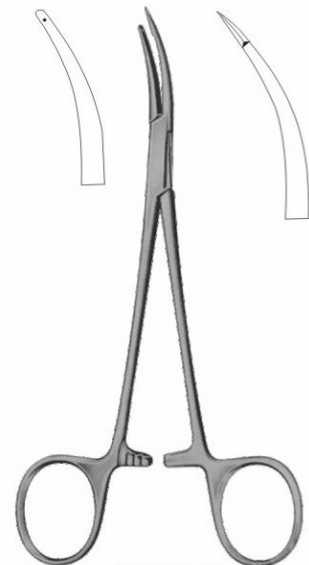

12-2140-15  
15 cm/6"

# Bone Instruments

Tendon Seizing Instruments  
Tendon ergriff Instruments

Tendon Instruments Saisir  
Aprovechar los instrumentos del tendón

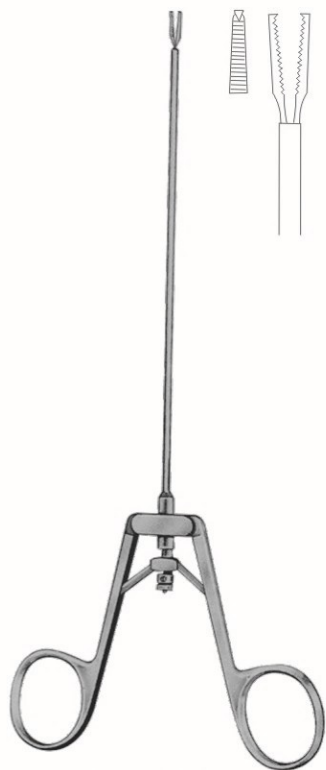

**Kleinert-Kutz**  
12-2141-20  
16 cm/8"



**Brand**  
12-2142-15 16 cm/6"  
12-2142-19 19 cm/7½"  
12-2142-24 24 cm/9½"



**Brand**  
12-2143-15 16 cm/6"  
12-2143-19 19 cm/7½"  
12-2143-24 24 cm/9½"