



13-2144-23
23 cm/9"
Bone Shears



13-2145-23
23 cm/9"
Bone Shears



Glick
13-2146-23
23 cm/9"
Drawing Cut

Cardiovascular Instruments

Rib Shears, Sternum Chisels
Rib, Sternumscheren Meißel

Costotome, ciseaux Sternum
Tijeras de costillas, esternón cinceles

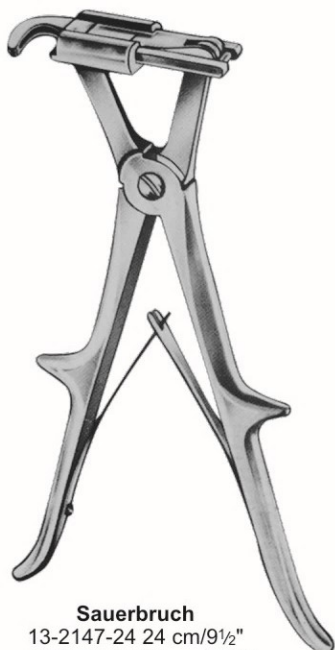

Sauerbruch
13-2147-24 24 cm/9½"
13-2147-26 26 cm/10¼"



Giertz-Stillle
13-2148-27
27 cm/10½"

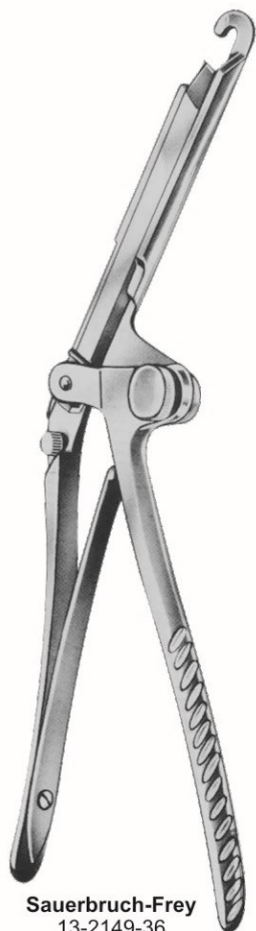

Sauerbruch-Frey
13-2149-36
36 cm/14"



Brunner
32 cm/12½"

13-2150-32
For the Right Hand
Für die rechte Hand
Pour la main droite
Para la mano derecha

13-2151-32
For the left Hand
Für die linke Hand
Pour la main gauche
Para la mano izquierda



Lebsche
13-2152-24
24.5 cm/9¾"

Schema of Dimensions
Schema der Dimensionen
Schéma des dimensions
Esquema de Medidas

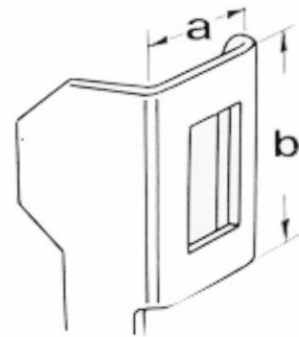

Size of Blades
Größe der Blätter
Taille des lames
Tamaño de Espadas

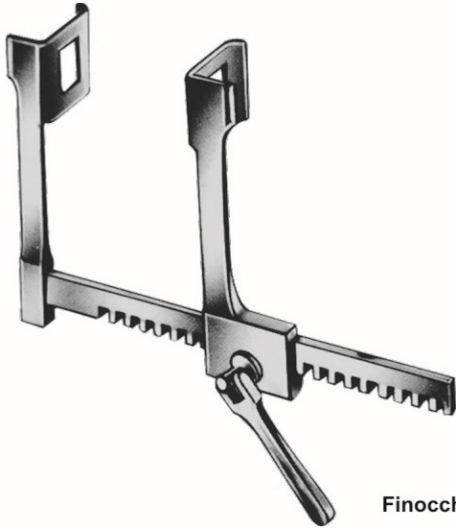

Finocchietto-Baby

	a	b	c
13-2153-00	18 mm	20 mm	75 mm

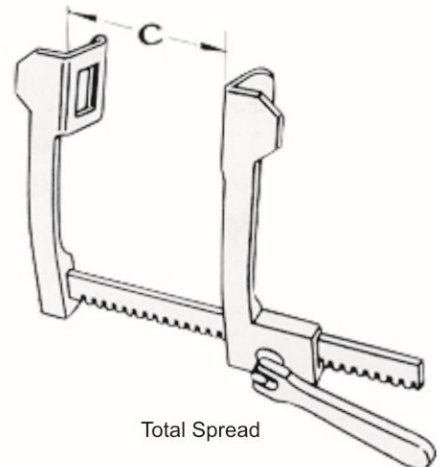

Total Spread



Finocchietto

	a	b	c
13-2154-01	38 mm	45 mm	165 mm
13-2154-02	44 mm	65 mm	200 mm
13-2154-03	44 mm	65 mm	250 mm
13-2154-04	44 mm	65 mm	300 mm
13-2154-05	65 mm	65 mm	200 mm
13-2154-06	65 mm	65 mm	250 mm
13-2154-07	65 mm	65 mm	300 mm

Cardiovascular Instruments

Rib Spreaders
Wundsperrer

Épandeurs Rib
Separadores de costilla



With 2 Pairs of Interchangeable Blades
Mit 2 Paar Wechselklingen
Avec 2 paires de lames interchangeables
Con 2 pares de cuchillas intercambiables

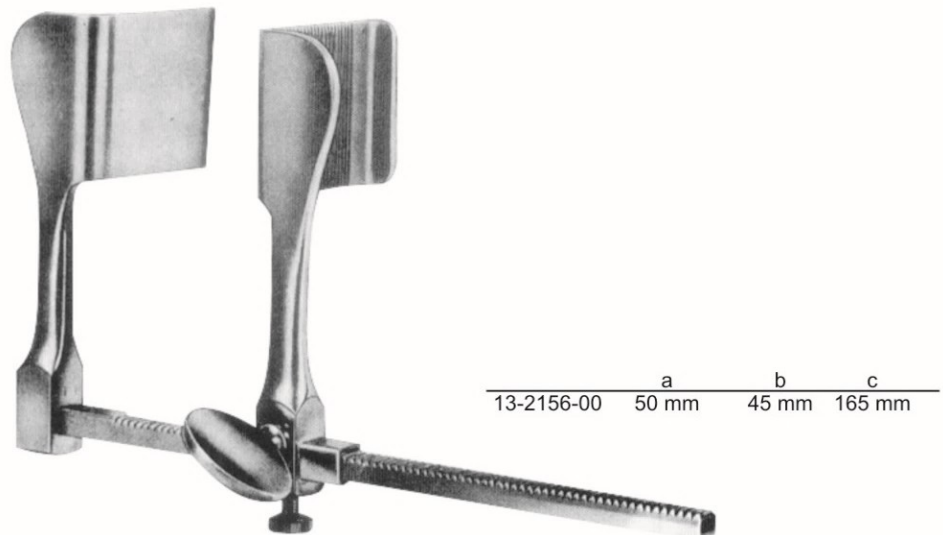

Tuffier

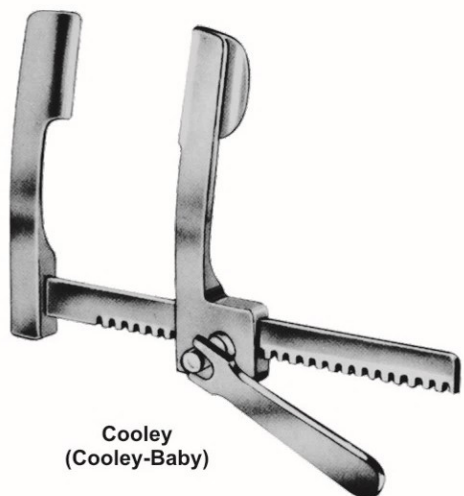

**Cooley
(Cooley-Baby)**

	a	b	c
13-2157-01	12 mm	17 mm	75 mm
13-2157-02	16 mm	30 mm	105 mm
13-2157-03	37 mm	49 mm	200 mm



Castaneda

	a	b	c
13-2158-01	10.5 mm	32 mm	65 mm
13-2158-02	12 mm	45 mm	70 mm
13-2158-03	15 mm	60 mm	120 mm



Finocchietto-Baby-Haight

	a	b	c
13-2159-01	15 mm	15 mm	75 mm
13-2159-02	31 mm	31 mm	100 mm

Cardiovascular Instruments

Rib Spreaders
Wundsperrer

Épandeurs Rib
Separadores de costilla



Haight

	a	b	c
13-2160-01	30 mm	30 mm	65 mm
13-2160-02	30 mm	30 mm	90 mm

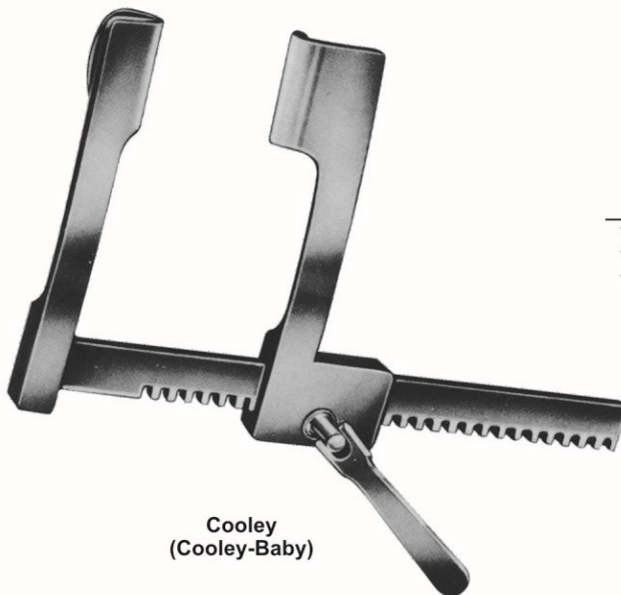

Cooley
(Cooley-Baby)

	a	b	c
13-2161-01	15 mm	30 mm	75 mm
13-2161-02	21 mm	45 mm	145 mm
13-2161-03	32 mm	50 mm	190 mm

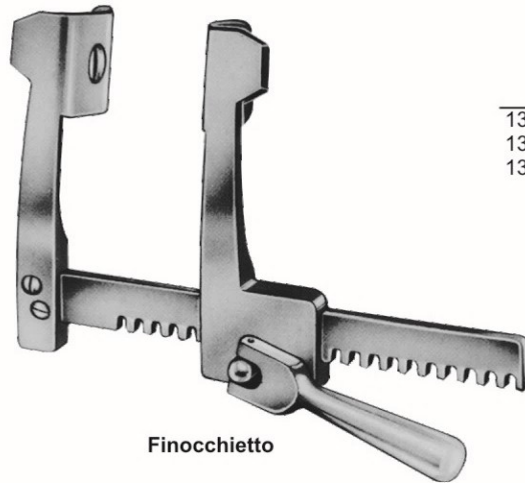

Finocchetto

	a	b	c
13-2162-01	38 mm	44 mm	135 mm
13-2162-02	52 mm	62 mm	175 mm
13-2162-03	85 mm	65 mm	175 mm

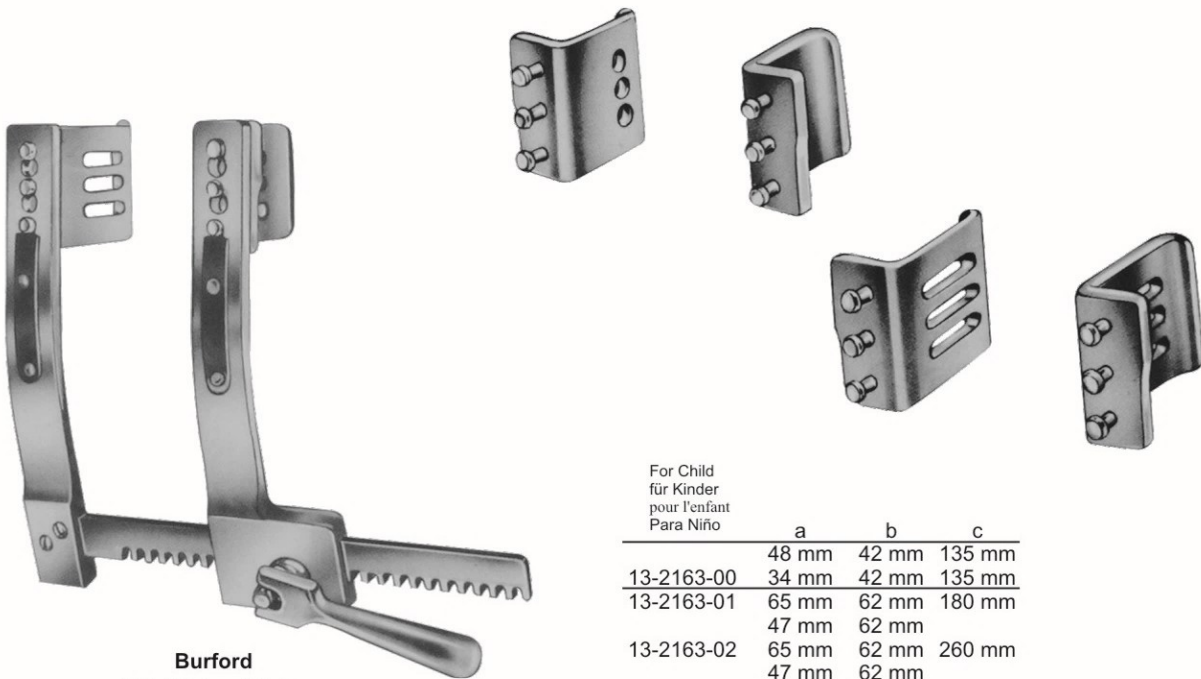

Burford

With 2 Pairs of Blades
Mit 2 Paar Blades
Avec 2 paires de lames
Con 2 pares de hojas

For Child
für Kinder
pour l'enfant
Para Niño

	a	b	c
	48 mm	42 mm	135 mm
13-2163-00	34 mm	42 mm	135 mm
13-2163-01	65 mm	62 mm	180 mm
	47 mm	62 mm	
13-2163-02	65 mm	62 mm	260 mm
	47 mm	62 mm	
13-2163-03	65 mm	62 mm	300 mm
	47 mm	62 mm	

Cardiovascular Instruments

Rib Spreaders
Wundsperrer

Épandeurs Rib
Separadores de costilla

With 2 pairs of interchangeable blades
Mit 2 Paar auswechselbaren Klingen
Avec 2 paires de lames interchangeables
Con 2 pares de hojas intercambiables

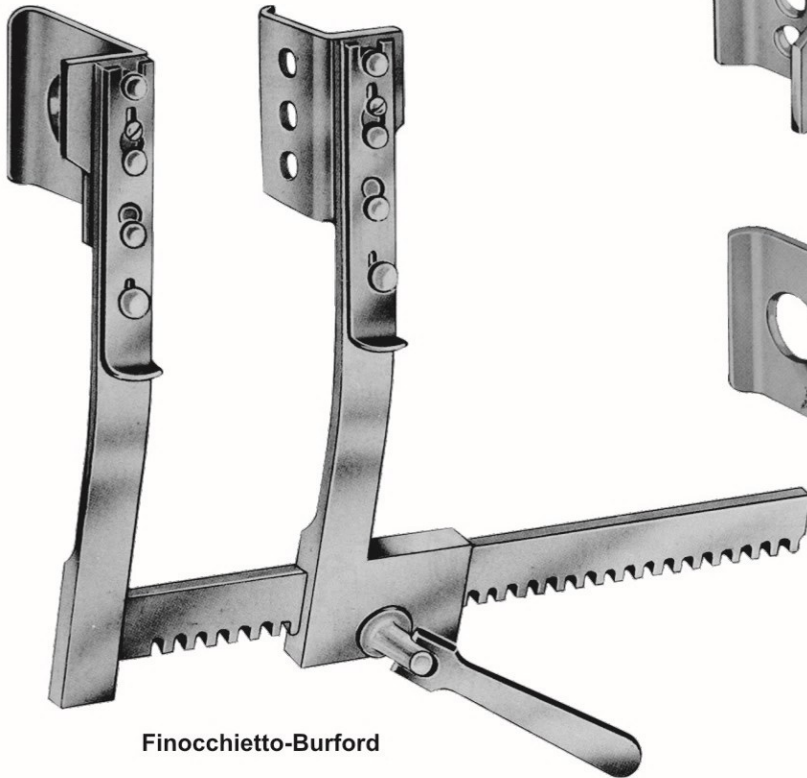

Finocchietto-Burford

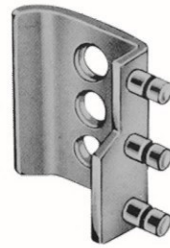

Blades
13-2164-31
80x67 mm

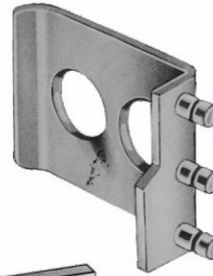

Blades
13-2163-30
40x67 mm

Total Spread

13-2165-01	200mm/8"
13-2165-02	250mm/10"
13-2165-03	305mm/12"



Tuffier

	a	b	c
13-2166-00	50 mm	45mm	165mm

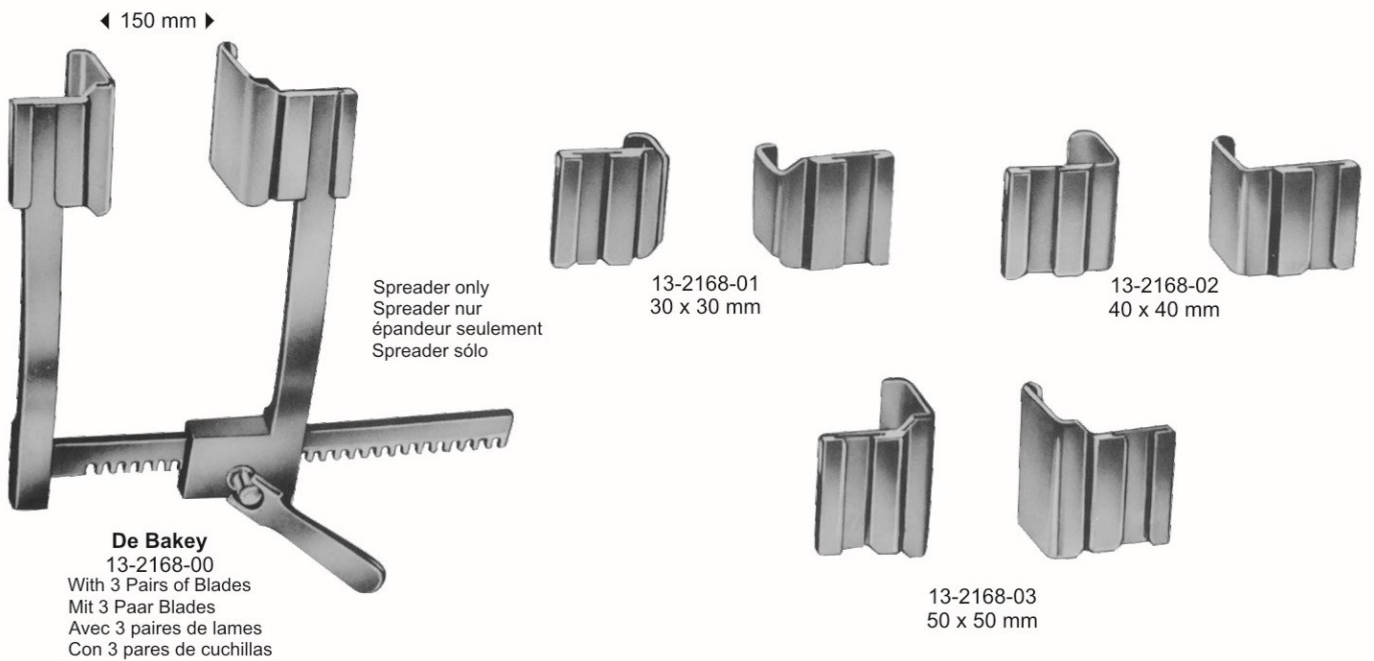
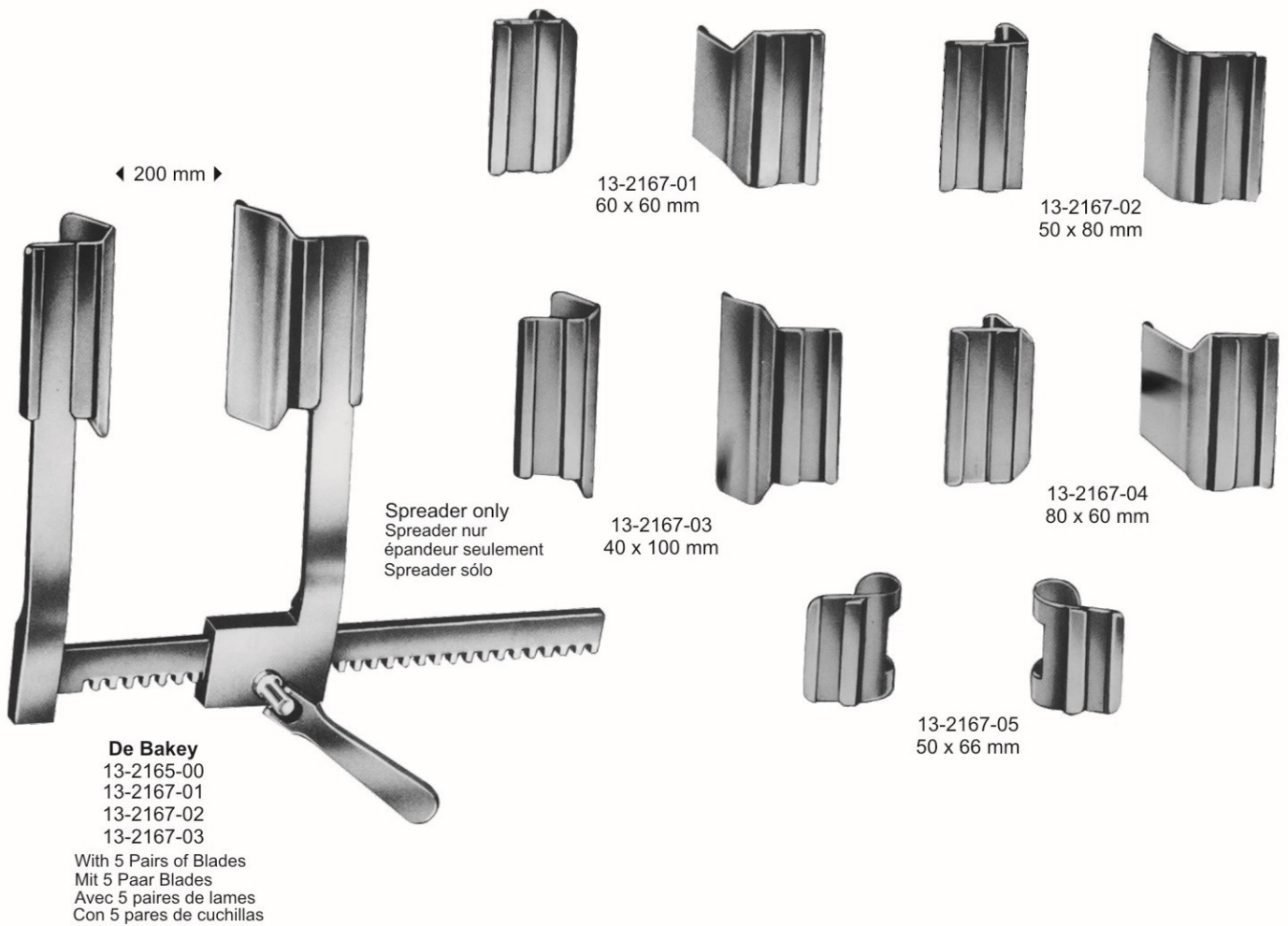

Cardiovascular Instruments

Rib Spreaders
Wundsperrer

Épandeurs Rib
Separadores de costilla

◀ Fig. 1 15 cm/6" ▶
◀ Fig. 2 20 cm/8" ▶

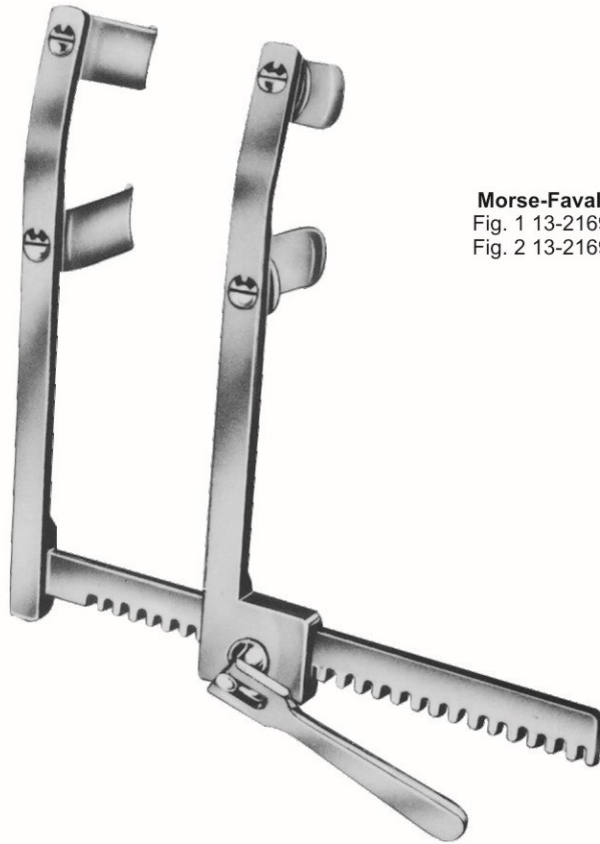

Morse-Favaloro
Fig. 1 13-2169-01
Fig. 2 13-2169-02

75 x 75 mm

Thoracic Retractor



42 x 65 mm

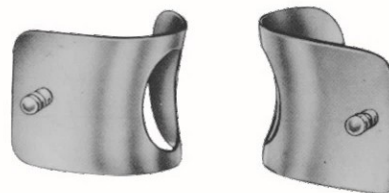

(Mercedes-Retractor)

13-2170-00

Complete
vervollständigen
completar
completar

Cardiovascular Instruments

Rib Contractors and Lung Spatulas

Rib Contractors und Lungenforschung Spatel

Entrepreneurs des côtes et du poumon Spatules

Contratistas de costilla y espátulas de pulmón



Sellors
13-2171-19
19 cm/7½"



Bailey-Baby
13-2172-14
14 cm/5½"



Bailey
13-2173-16
16 cm/6¼"



Bailey-Gibbon
13-2174-16
16 cm/6¼"

Cardiovascular Instruments

Lung Spatulas
Lung Spatel

Spatules du poumon
Espátulas de pulmón

Accu-Med[®]
Instrument Co.



Allison

13-2175-25 25.5 cm/10"
13-2175-30 30.0 cm/12"

Lung Spatulas
Lung Spatel
Spatules pulmonaires
Espátulas de pulmón

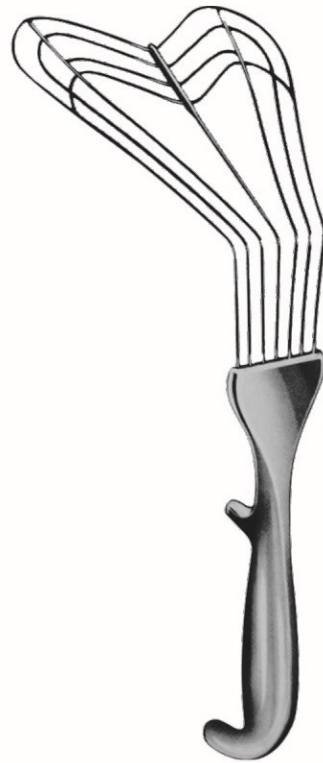

13-2176-30
30 cm/12"

Cardiovascular Instruments

Bronchus Clamps and Blood Vessel Clamps
Bronchus Schellen und Blutgefäßen Schellen

Pincers des bronches et des colliers Vasculopathies
Abrazaderas Abrazaderas de los bronquios y los vasos
sanguíneos



Price-Thomas
13-2177-22
22 cm/8¾"

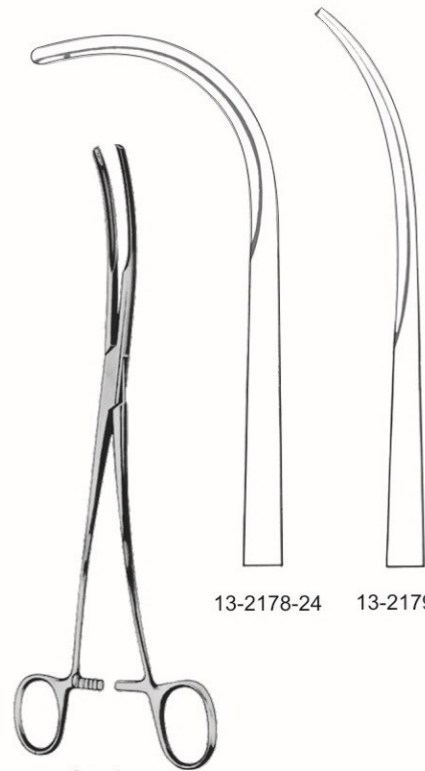

Semb
24 cm/9½"

13-2178-24 13-2179-24

Lung grasping forceps



Lovlace
13-2180-20
20 cm/8"



Lovlace
13-2181-20
20 cm/8"

Cardiovascular Instruments

Blood Vessel Clamps
Blutgefäß Schellen

Pinces Vasculopathies
Las abrazaderas de los vasos sanguíneos



13-2182-01
13-2182-02

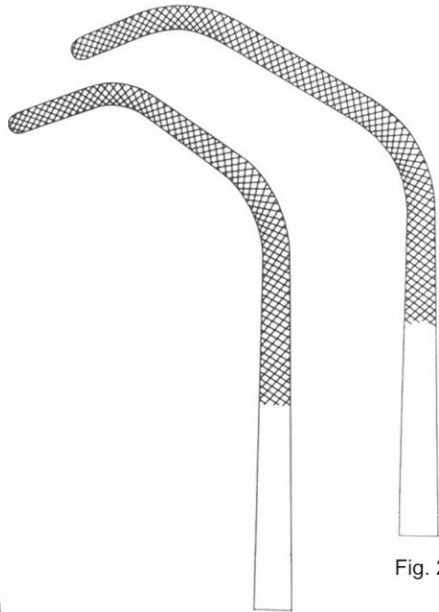

Fig. 1

Fig. 2

Satinsky
26.5 cm/10½"
Fig. 1
Fig. 2



13-2183-01
13-2183-02



Baby-Satinsky
13-2184-15
15 cm/6"



Harken
24 cm/9½"

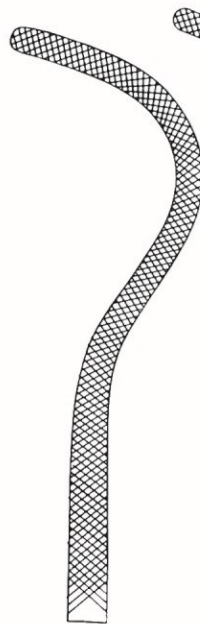

13-2185-01



13-2185-02

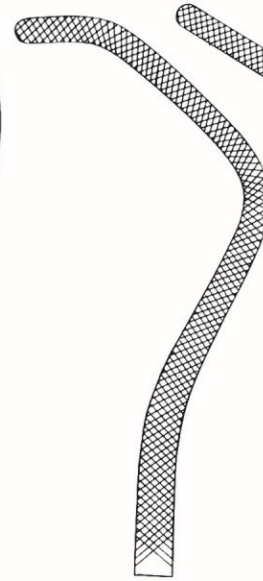

13-2185-03



13-2185-04

Cardiovascular Instruments

Atrauma Bulldog Clamps
Atrauma Bulldogklemmen

Atraumatique Pinces Bulldog
Atrauma Bulldog Clamps



De Bakey-Satinsky
13-2186-07
7 cm/2³/₄"



De Bakey-Satinsky
13-2187-09
9 cm/3¹/₂"

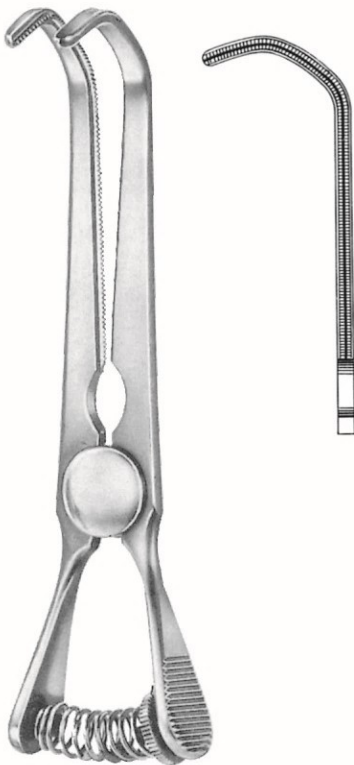

De Bakey-Satinsky
13-2188-10
10 cm/4"



Glover
13-2189-06
6 cm/2¹/₄"

Cardiovascular Instruments

Atrauma Bulldog Clamps
Atrauma Bulldogklemmen

Atraumatique Pincès Bulldog
Atrauma Bulldog Clamps



Santulli
13-2190-07
7 cm/2¾"

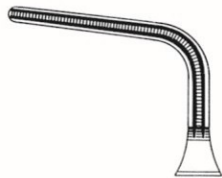

Gregory-Soft



13-2191-09
9 cm/3½"

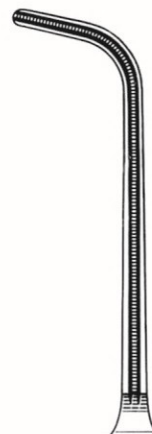

13-2191-11
11 cm/4½"



Gregory



13-2192-09
10.5 cm/4"



13-2192-10
10.5 cm/4"

Bulldog Clamps
Bulldogklemmen

Pinces Bulldog
Bulldog Clamps

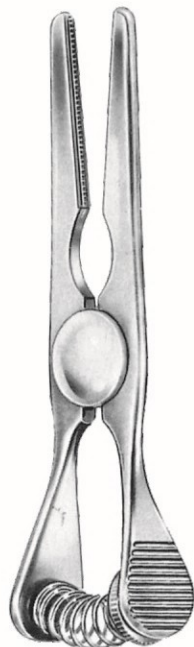

Glover



13-2193-09
7cm/2 3/4"



13-2194-11
7.5 cm/3"



13-2195-09
9 cm/3 1/2"



13-2196-11
11 cm/4 1/4"

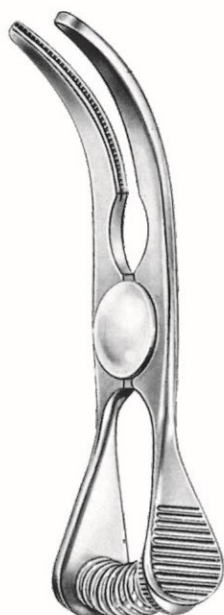

Glover



13-2197-09
6.5cm/2 1/2"



13-2198-11
7 cm/2 3/4"



13-2199-09
8.5 cm/3 1/4"



13-2200-11
10.5 cm/4"

Cardiovascular Instruments

Bulldog Clamps
Bulldogklemmen

Pinces Bulldog
Bulldog Clamps



DeBakey



13-2201-07
7.5 cm/3"



13-2201-08
8.5 cm/3 1/4"



13-2201-10
10 cm/4"



13-2201-12
12 cm/4 3/4"

Applying Forceps
for Bulldog clamps

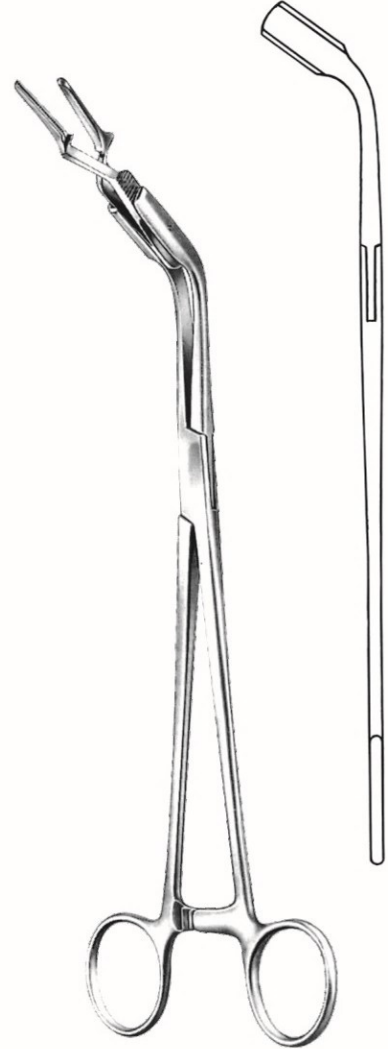

13-2203-23
23.5 cm/9 1/4"



DeBakey



13-2202-07
7.5 cm/3"



13-2202-08
8.5 cm/3 1/4"



13-2202-09
9.5 cm/4 3/4"



13-2202-12
11 cm/4 1/4"

Cardiovascular Instruments

Haemostatic Forceps and Aortic Clamps
Arterienklemme und Aorten-Schellen

Forceps Hémostatique et clamps aortiques
Pinzas hemostáticas y Abrazaderas aórticas

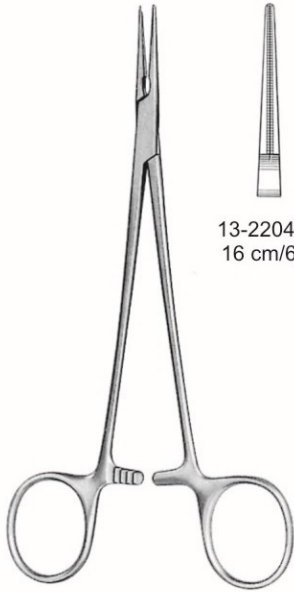

DeBakey-Rankin

13-2204-01
16 cm/6 1/4"

13-2204-02
16 cm/6 1/4"

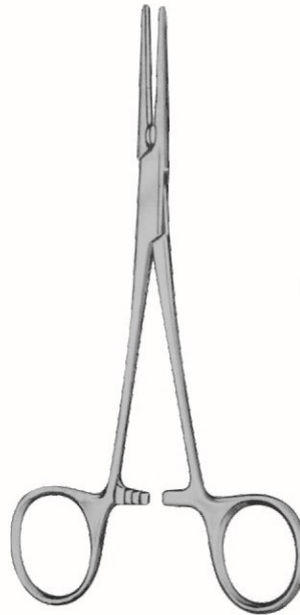

DeBakey-Mosquito

13-2205-01
15 cm/6 "

13-2205-02
16 cm/6"



Ochsner

13-2206-23
23.5 cm/9 1/4"



Diethrich

13-2207-22
22cm/6 3/4"

Cardiovascular Instruments

Multi Purpose vascular Clamps
Multi Purpose Gefäßklemmen

Pinces Multi Purpose vasculaires
Pinzas Multiuso vasculares

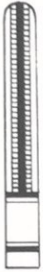

13-2208-00

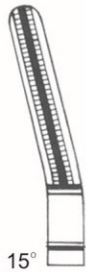

15°
13-2208-15

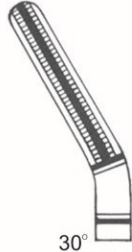

30°
13-2208-30

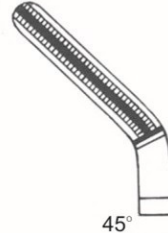

45°
13-2208-45

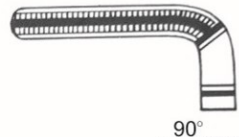

90°
13-2208-90

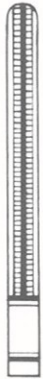

13-2209-00

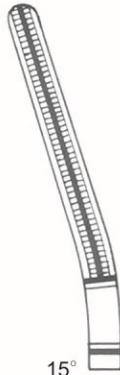

15°
13-2209-15

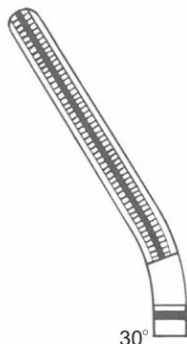

30°
13-2209-30

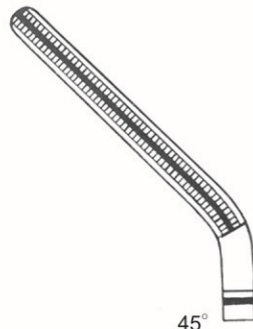

45°
13-2209-45

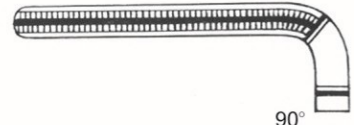

90°
13-2209-90



Dardik
17 cm/6 $\frac{3}{4}$ "

Cardiovascular Instruments

Peripheral Vascular Clamps
Peripheral Vascular Clamps

Clamps vasculaires périphériques
Pinzas vasculares periféricas



Dale

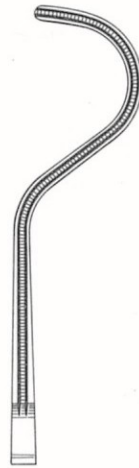

13-2210-17
17.5 cm/6¾"

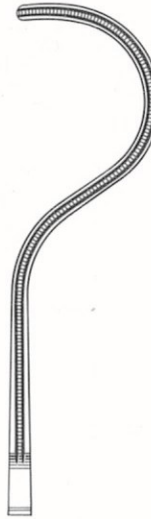

13-2210-18
18 cm/7"

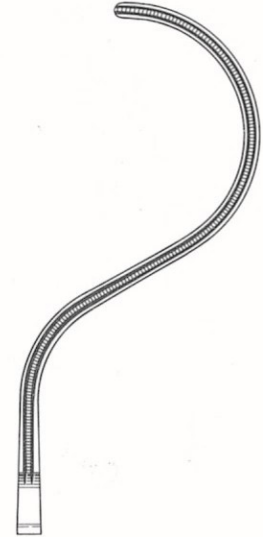

13-2210-19
18.5 cm/7¼"



Dale

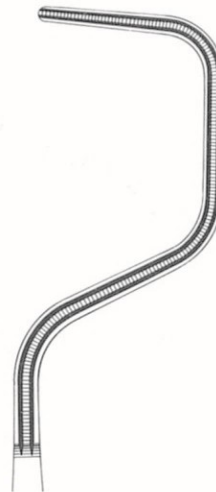

13-2211-18
18 cm/7"

Cardiovascular Instruments

Profunda and Carotid shunt Clamps
Profunda und Karotis-Shunt-Schellen

Pinces shunt profunda et carotidienne
Profunda y abrazaderas de derivación carotídea



Gregory

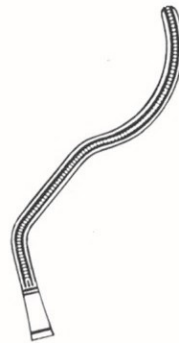

13-2212-14
13 cm/5"

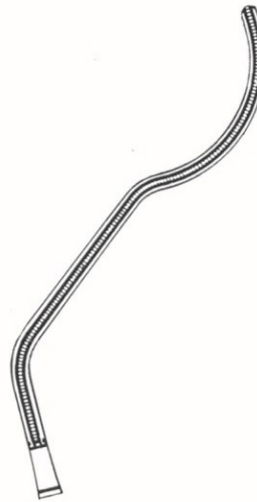

13-2212-16
16 cm/6 1/4"

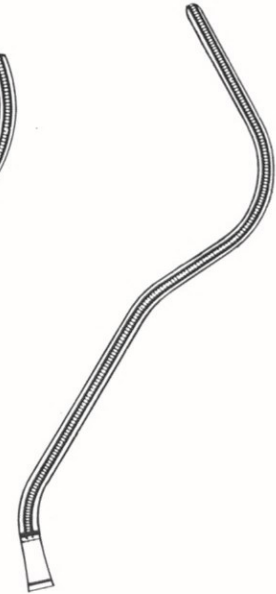

13-2212-18
18 cm/7"



Javid



13-2213-17
17.5 cm/7"

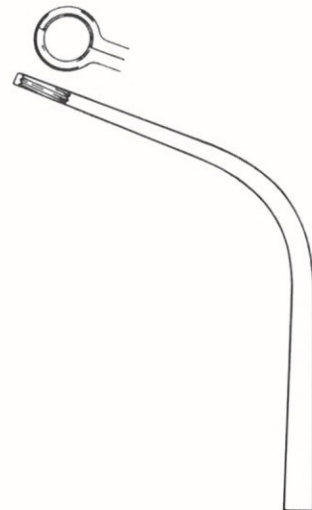

13-2213-18
18 cm/7"



13-2214-01
16 cm/6 1/4"
24 Charr



13-2214-02
16 cm/6 1/4"
26 Charr

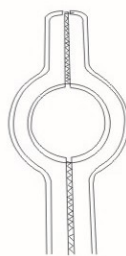

13-2214-03
20 cm/8"
28 Charr



13-2214-04
20 cm/8"
30 Charr

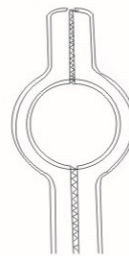

13-2214-05
20 cm/8"
32 Charr

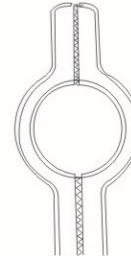

13-2214-07
20 cm/8"
36 Charr



Cooley

Cardiovascular Instruments

Vascular Forceps
Vaskuläre Zange

Pince vasculaires
Pinzas vasculares

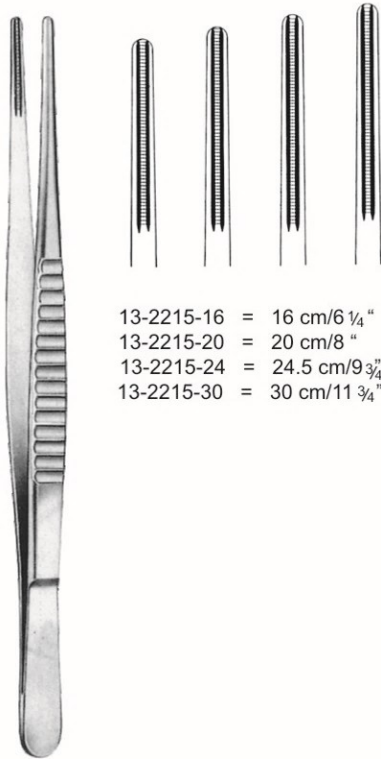

- 13-2215-16 = 16 cm/6 1/4"
- 13-2215-20 = 20 cm/8"
- 13-2215-24 = 24.5 cm/9 3/4"
- 13-2215-30 = 30 cm/11 3/4"

DeBakey
2.7mm

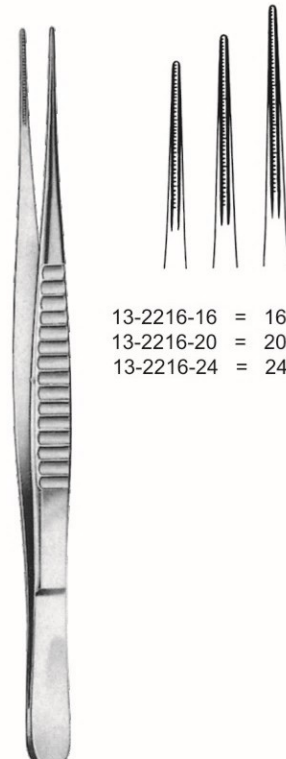

- 13-2216-16 = 16 cm/6 1/4"
- 13-2216-20 = 20 cm/8"
- 13-2216-24 = 24.5 cm/9 3/4"

DeBakey
1.5mm

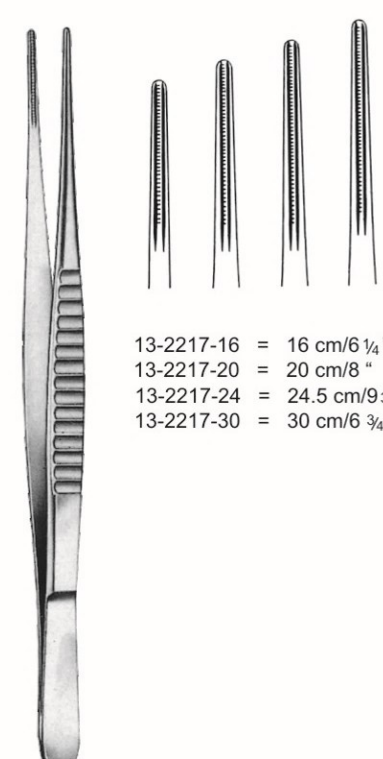

- 13-2217-16 = 16 cm/6 1/4"
- 13-2217-20 = 20 cm/8"
- 13-2217-24 = 24.5 cm/9 3/4"
- 13-2217-30 = 30 cm/11 3/4"

DeBakey
2.5mm

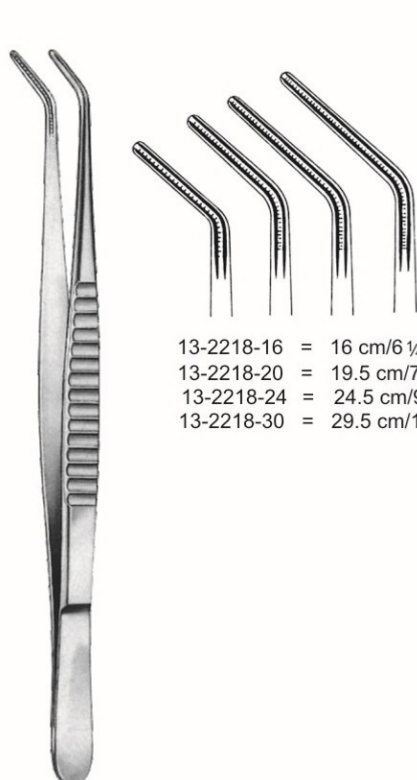

- 13-2218-16 = 16 cm/6 1/4"
- 13-2218-20 = 19.5 cm/7 3/4"
- 13-2218-24 = 24.5 cm/9"
- 13-2218-30 = 29.5 cm/11 3/4"

DeBakey
2.0mm

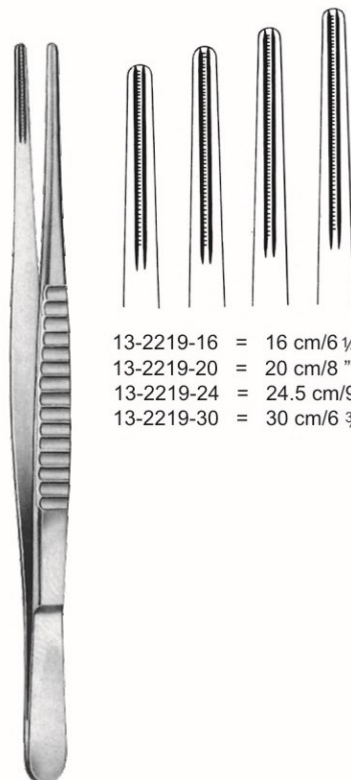

- 13-2219-16 = 16 cm/6 1/4"
- 13-2219-20 = 20 cm/8"
- 13-2219-24 = 24.5 cm/9 3/4"
- 13-2219-30 = 30 cm/11 3/4"

DeBakey
3.5mm

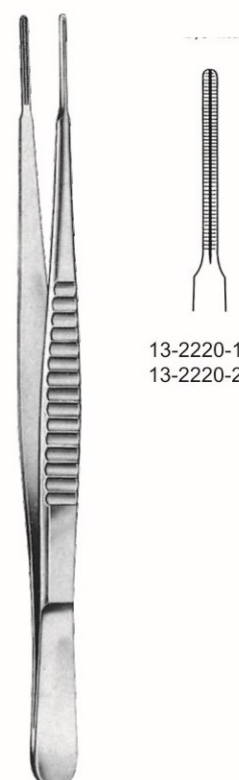

- 13-2220-16 = 16 cm/6 1/4"
- 13-2220-20 = 20 cm/8"

DeBakey
2.0mm

Cardiovascular Instruments

Peripheral Vascular Clamps
Peripheral Vascular Clamps

Clamps vasculaires périphériques
Pinzas vasculares periféricas

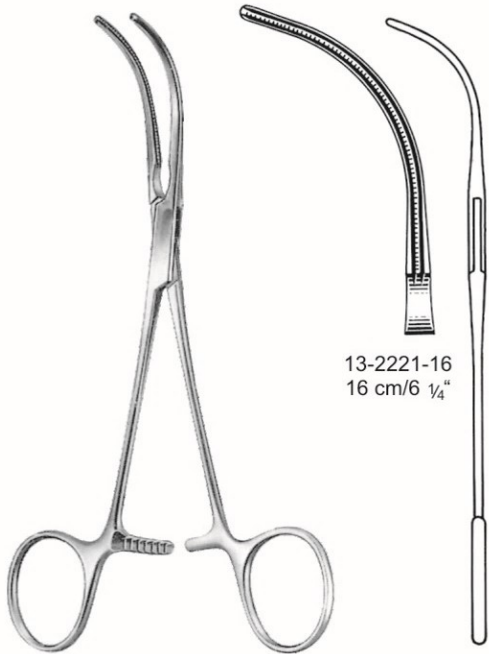

13-2221-16
16 cm/6 1/4"

DeBakey

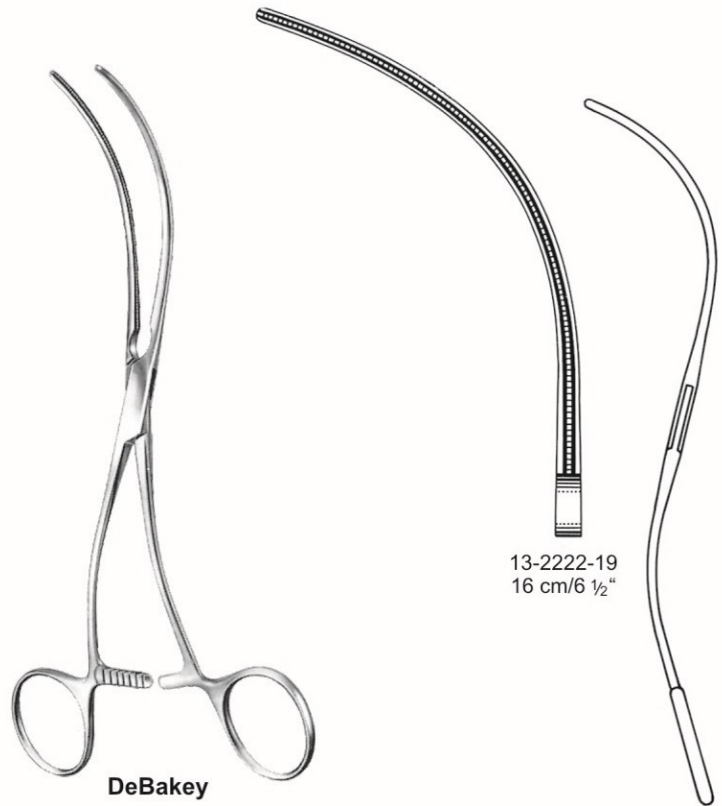

13-2222-19
16 cm/6 1/2"

DeBakey



13-2223-18
18 cm/6"

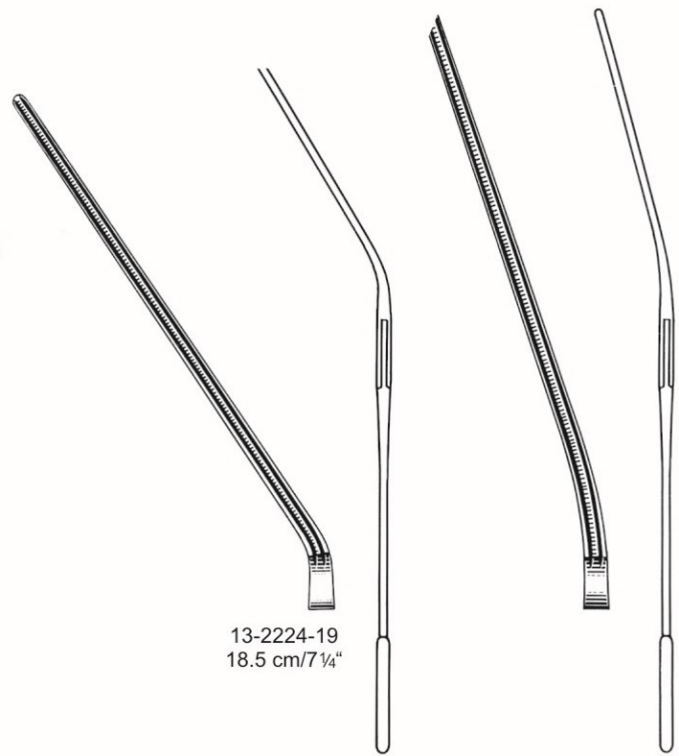

13-2224-19
18.5 cm/7 1/4"

Cardiovascular Instruments

Multi Purpose Vascular Clamps
Multi Purpose Gefäßklemmen

Pinces Multi Purpose vasculaires
Pinzas Multiuso vasculares



Bainbridge

13-2225-15
15 cm/6 "



13-2226-18
18.5 cm/7 1/4 "



Bainbridge

13-2227-15
15 cm/6 "



13-2228-18
18.5 cm/7 1/4 "

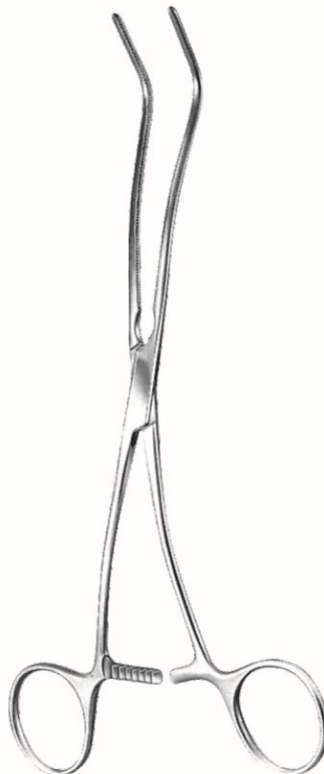

DeBakey

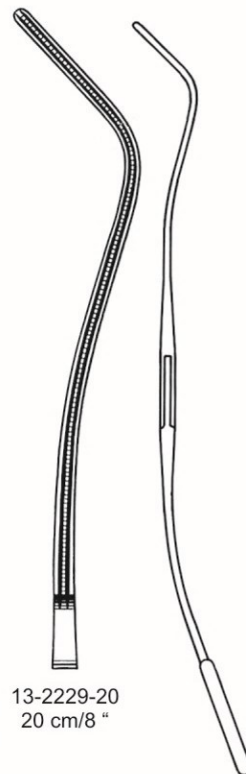

13-2229-20
20 cm/8 "

Cardiovascular Instruments

Aortic Aneurysm Clamps
Aortenaneurysma Schellen

Pinces anévrisme aortique
Las abrazaderas de aneurismas aórticas



13-2230-28
28cm/11"

DeBakey



13-2231-30
30cm/11¾"

DeBakey

Cardiovascular Instruments

Aortic Aneurysm Clamps
Aortenaneurysma Schellen

Pinces anévrisme aortique
Las abrazaderas de aneurismas aórticas

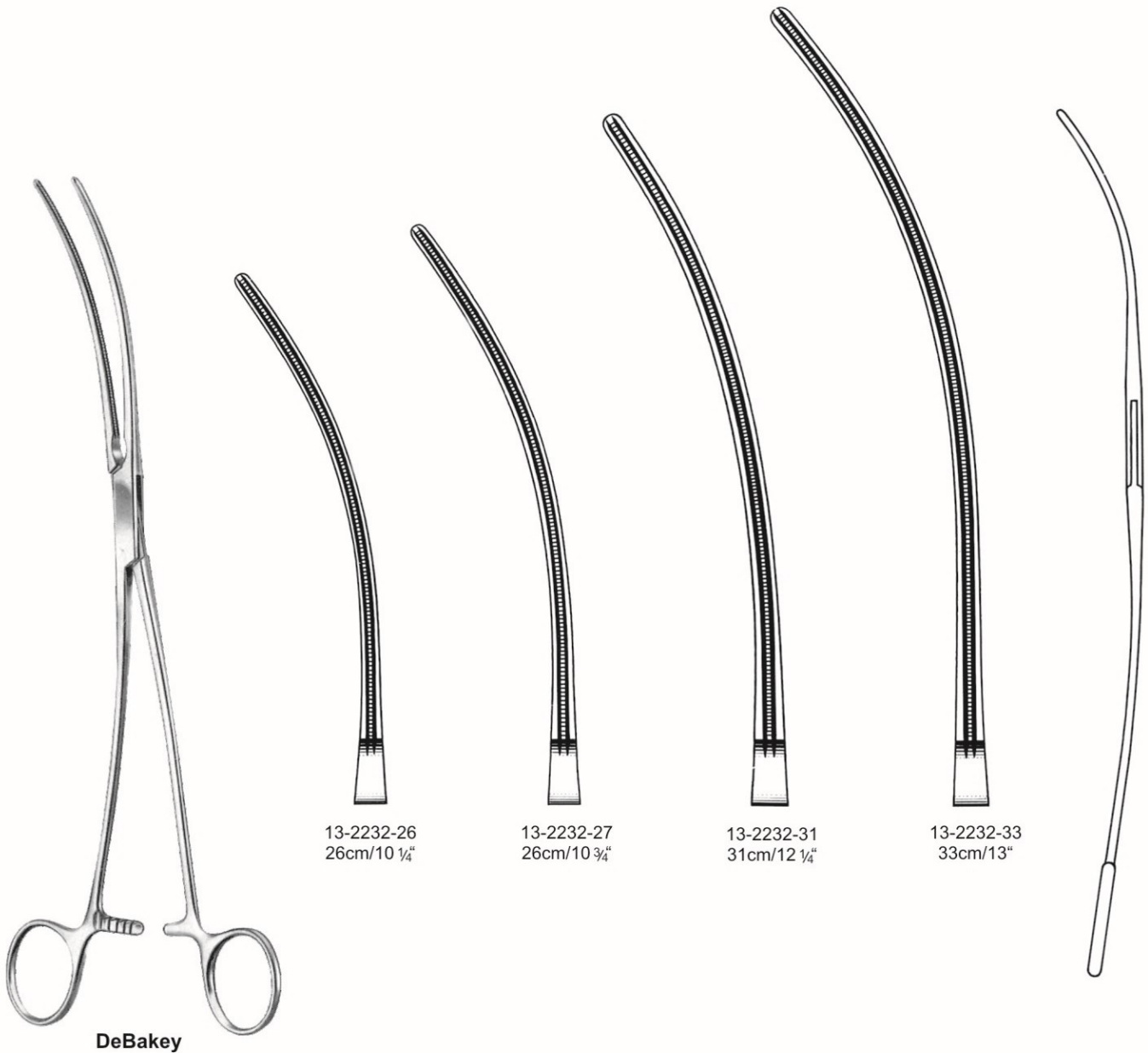

Cardiovascular Instruments

Aortic Clamps, Ligature Forceps
Aorten-Klemmen, Ligaturklemmen

Clamps aortiques, pincas de ligature
Abrazaderas aórticas, pinzas de ligadura

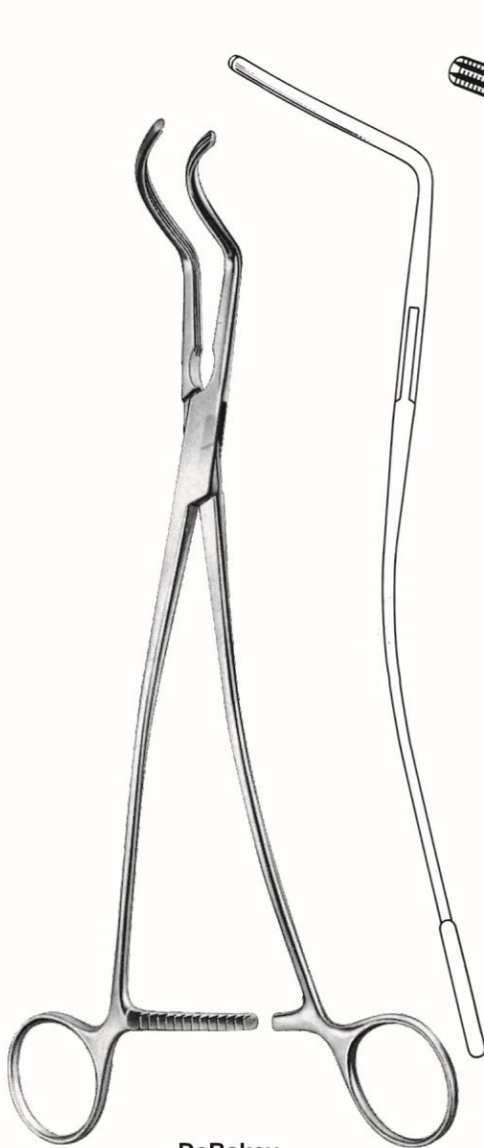

DeBakey
13-2233-27
27cm/10 3/4"

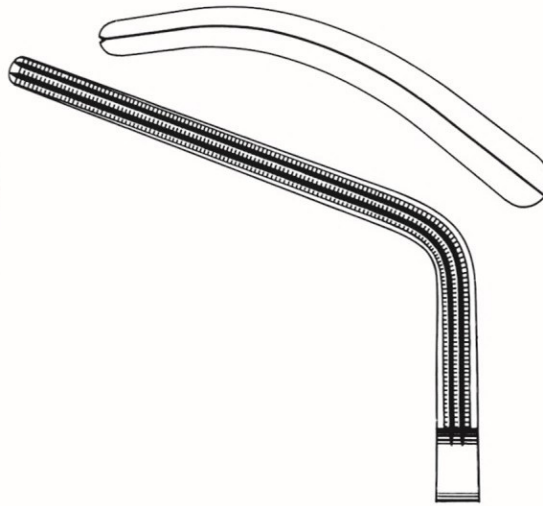

13-2234-24
24.5cm/9 3/4"



DeBakey

Cardiovascular Instruments

Aortic Clamps, Ligature Forceps
Aorten-Klemmen, Ligaturklemmen

Clamps aortiques, pinces de ligature
Abrazaderas aórticas, pinzas de ligadura



13-2235-24
24.5cm/9 3/4"

DeBakey



13-2236-25
27cm/10 1/2"

DeBakey

Cardiovascular Instruments

Aortic Clamps, Ligature Forceps
Aorten-Klemmen, Ligaturklemmen

Clamps aortiques, pinces de ligature
Abrazaderas aórticas, pinzas de ligadura



13-2237-26
27cm/10 1/2"

DeBakey

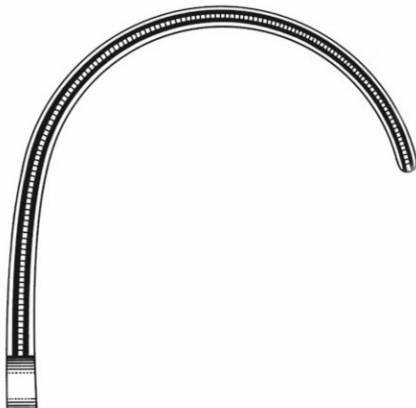

13-2238-01
24cm/9 1/2"

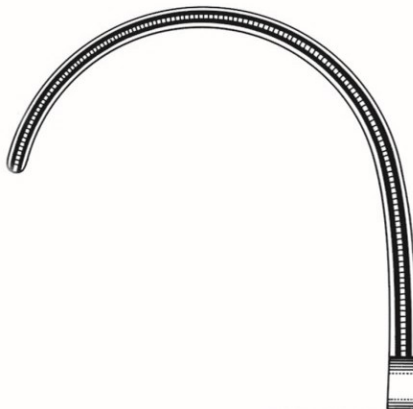

13-2238-02
24cm/9 1/2"



Weber

Cardiovascular Instruments

Auricle Clamps
Ohrmuschel Schellen

Pinces oreillette
Abrazaderas aurícula



Harken



13-2239-01
24.5cm/9 3/4"

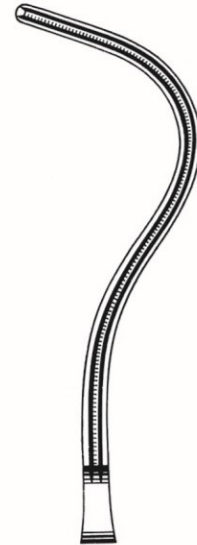

13-2239-02
24.5cm/9 1/2"

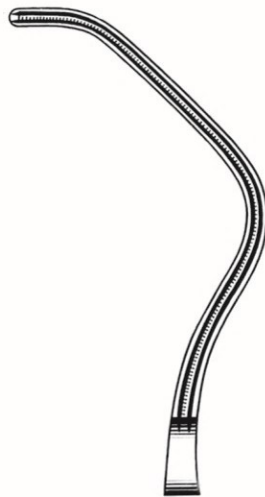

13-2239-03
24.5cm/9"



13-2239-04
24.5cm/9 1/4"



Cardiovascular Instruments

Tangential Occlusion Clamps
Tangentiale Occlusion Schellen

Pinces d'occlusion tangentielles
Abrazaderas tangenciales de oclusión



13-2240-22
22 cm/8 $\frac{3}{4}$ "



13-2240-26
26 cm/8 $\frac{1}{4}$ "



13-2240-25
25.5 cm/8 $\frac{1}{2}$ "



Satinsky



13-2240-27
27.5 cm/10 $\frac{3}{4}$ "



13-2240-28
28.5 cm/11 $\frac{1}{4}$ "

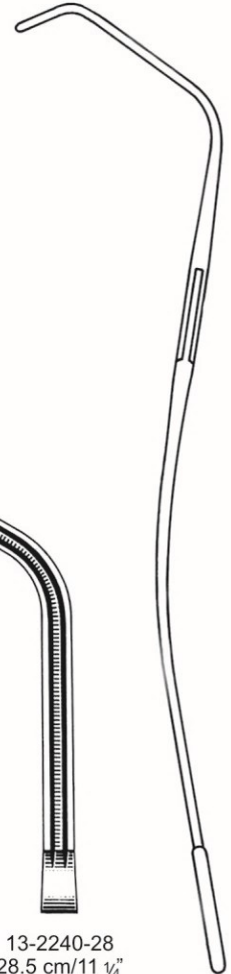

Cardiovascular Instruments

Bronchus Clamps
bronchus-Schellen

Pincas bronchus
Abrazaderas de bronquios

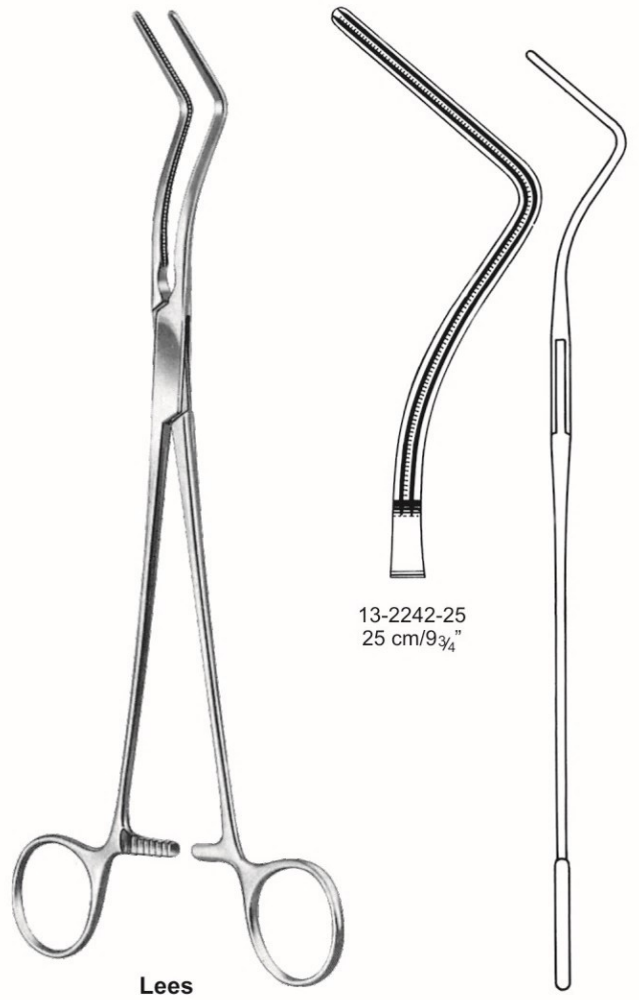

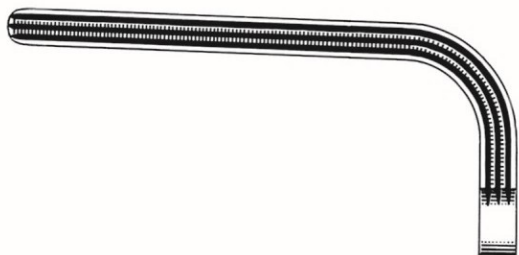

13-2243-16
16.5 cm/6 1/2"

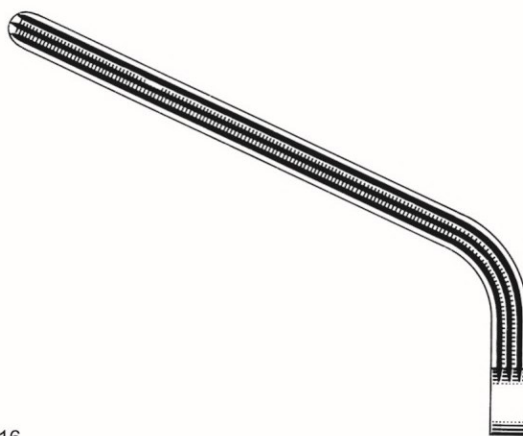

13-2243-20
20 cm/8"



Morris-DeBakey

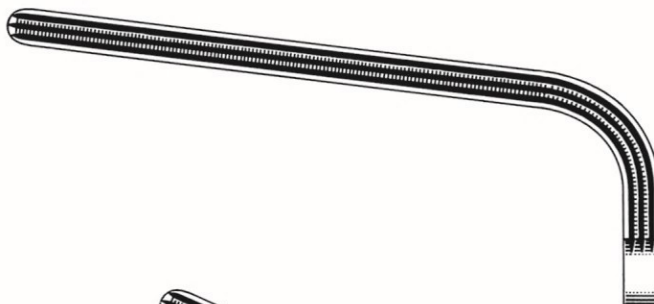

13-2243-24
24 cm/9 1/2"

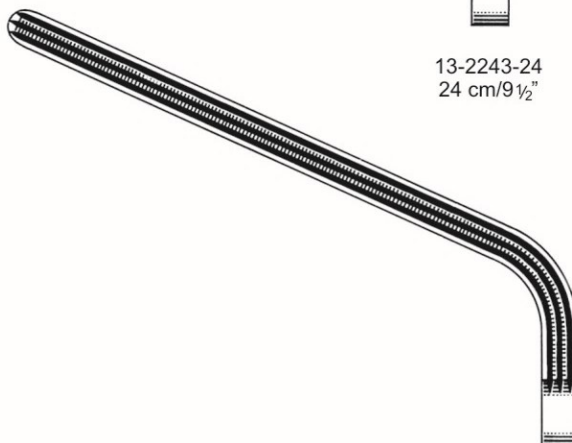

13-2243-26
26 cm/10 1/4"



Cardiovascular Instruments

Anastomosis Clamps
Anastomose Schellen

Pinces anastomose
Abrazaderas anastomosis



Morris-DeBakey



13-2244-22
22.5 cm/8 3/4"

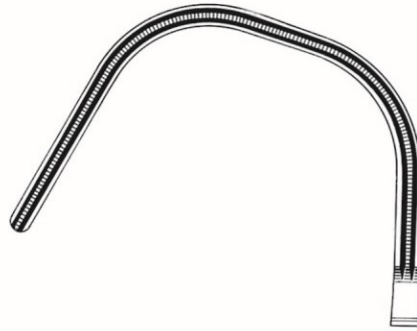

13-2244-22
22.5 cm/8 3/4"

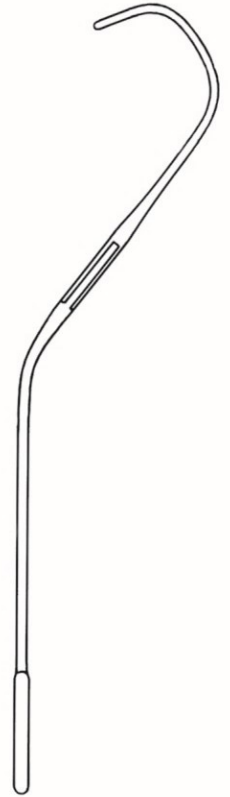

DeBakey

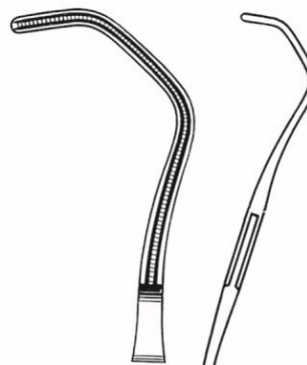

13-2245-16
16.5 cm/6 1/2"



DeBakey-Bahnson

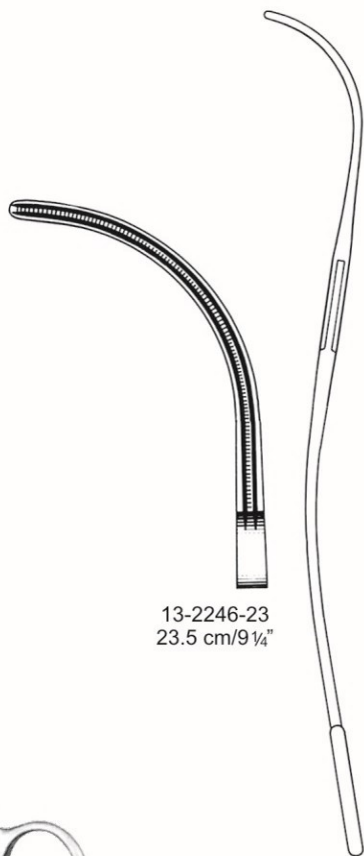

13-2246-23
23.5 cm/9 1/4"

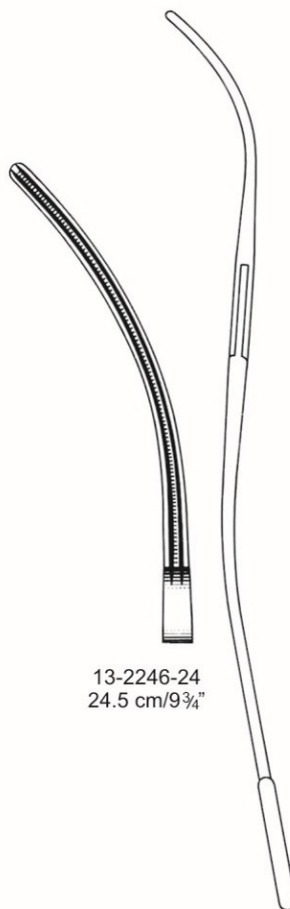

13-2246-24
24.5 cm/9 3/4"



13-2246-25
25.5 cm/10 "

Cardiovascular Instruments

Multi purpose Vascular Clamps
Mehrzweck Gefäßklemmen

Pinces multi usages vasculaires
Abrazaderas multipropósito vasculares



DeBakey

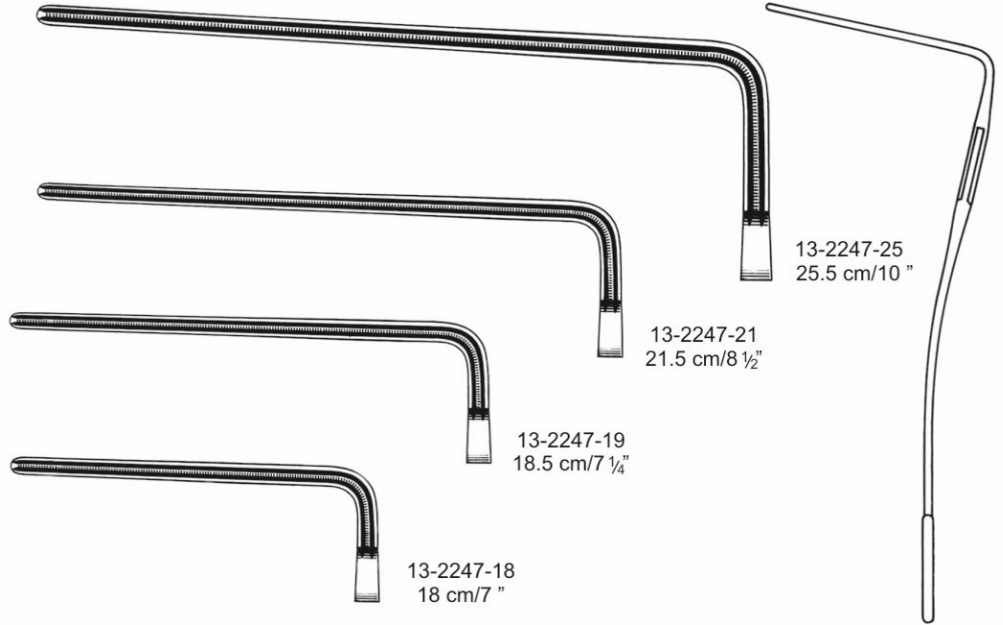

13-2247-25
25.5 cm/10 "

13-2247-21
21.5 cm/8 1/2 "

13-2247-19
18.5 cm/7 1/4 "

13-2247-18
18 cm/7 "



DeBakey

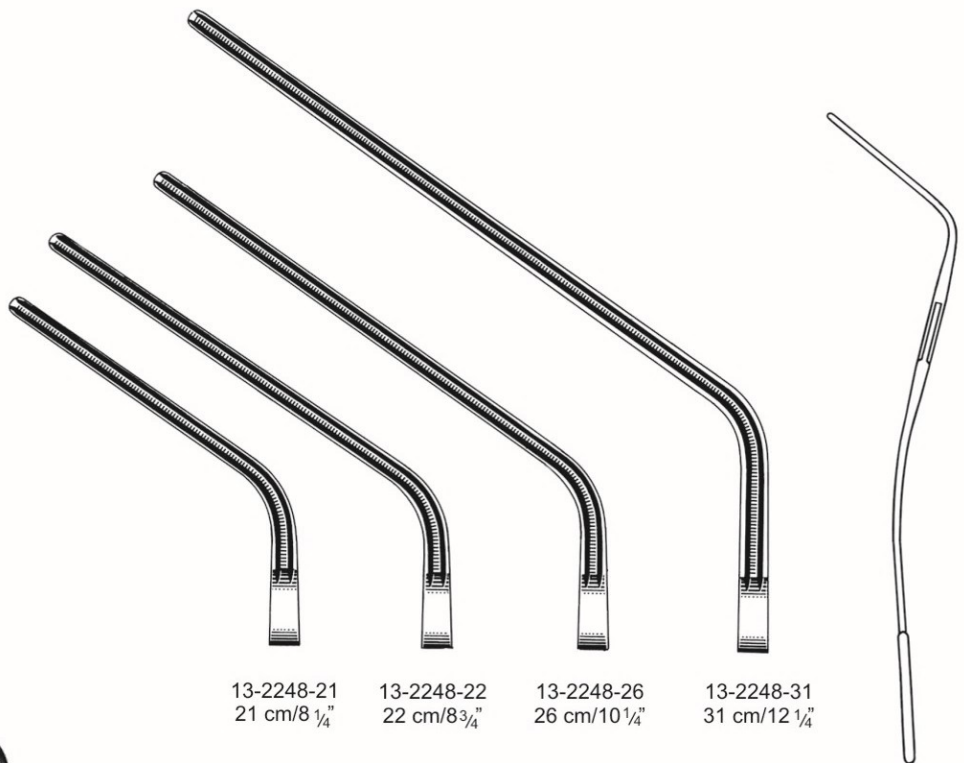

13-2248-21
21 cm/8 1/4 "

13-2248-22
22 cm/8 3/4 "

13-2248-26
26 cm/10 1/4 "

13-2248-31
31 cm/12 1/4 "

Cardiovascular Instruments

Multi purpose Vascular Clamps
Mehrzweck Gefäßklemmen

Pinces multi usages vasculaires
Abrazaderas multipropósito vasculares



Potts



13-2249-21
21.5 cm/8½"



13-2249-23
23.5 cm/9¼"



13-2249-27
27 cm/9¾"



13-2249-31
31 cm/12¼"



13-2250-21
21 cm/8¼"



13-2250-23
23 cm/9"



13-2250-26
26 cm/9¾"



13-2250-30
30.5 cm/12"

Cardiovascular Instruments

Haemosttic Forceps
Haemoststic Zange

Pince Haemoststic
Pinzas Haemoststic



DeBakey-Pean



13-2251-14
14.5 cm/5 3/4"



13-2251-16
16.5 cm/5 1/4"

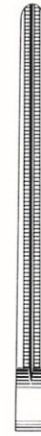

13-2251-18
18.5 cm/7 1/4"

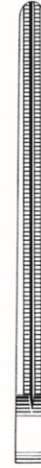

13-2251-20
20.5 cm/8 "

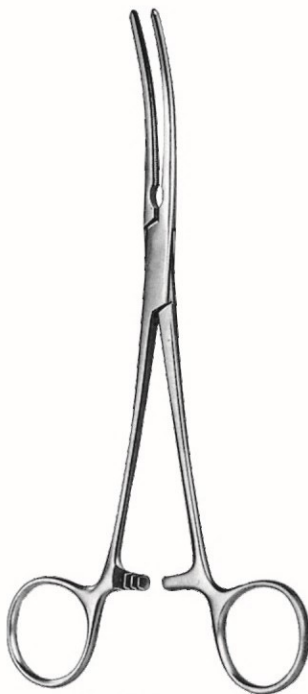

DeBakey-Pean



13-2252-14
14.5 cm/5 3/4"



13-2252-16
16.5 cm/5 1/4"



13-2252-18
18.5 cm/7 1/4"



13-2252-20
20.5 cm/8 "

Cardiovascular Instruments

Multi purpose Vascular Clamps
Mehrzweck Gefäßklemmen

Pinces multi usages vasculaires
Abrazaderas multipropósito vasculares

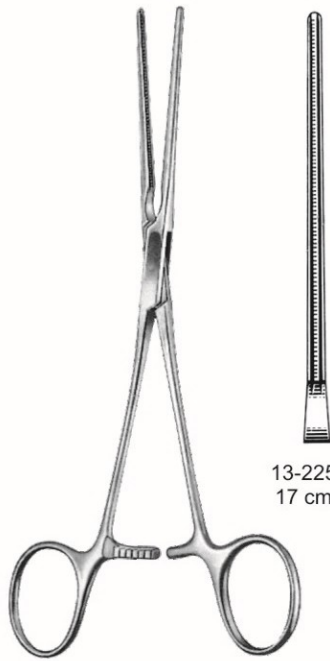

13-2253-17
17 cm/7 3/4"

DeBakey

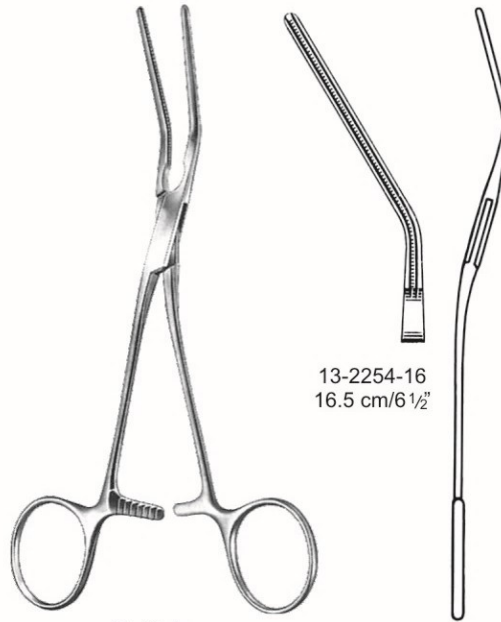

13-2254-16
16.5 cm/6 1/2"

DeBakey



13-2255-16
16 cm/6 1/2"

DeBakey



13-2256-14
14.5 cm/5 3/4"

DeBakey

Cardiovascular Instruments

Multi purpose Vascular Clamps
Mehrzweck Gefäßklemmen

Pinces multi usages vasculaires
Abrazaderas multipropósito vasculares

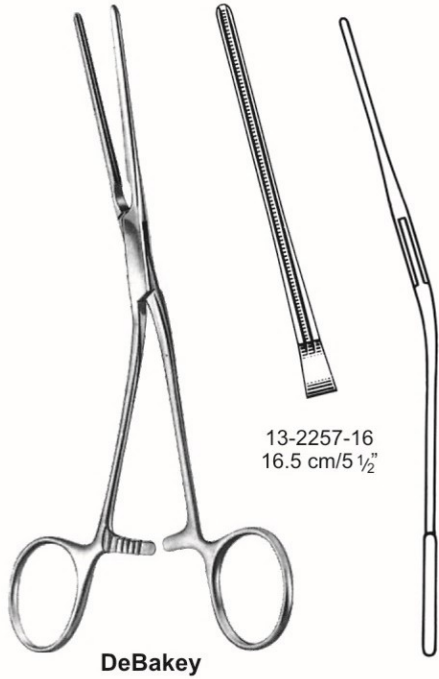

13-2257-16
16.5 cm/5 1/2"

DeBakey

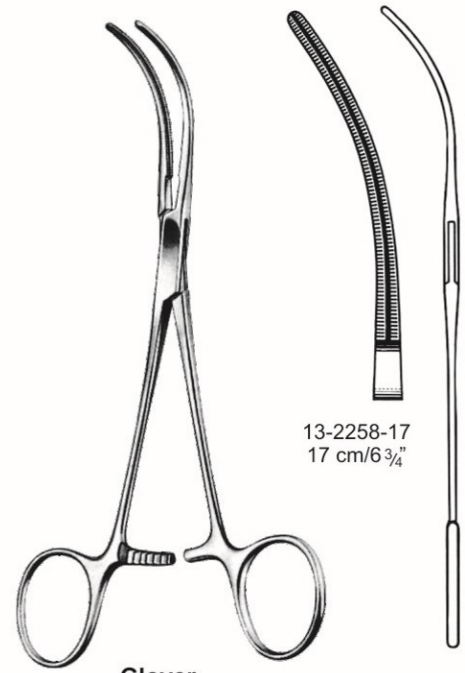

13-2258-17
17 cm/6 3/4"

Glover

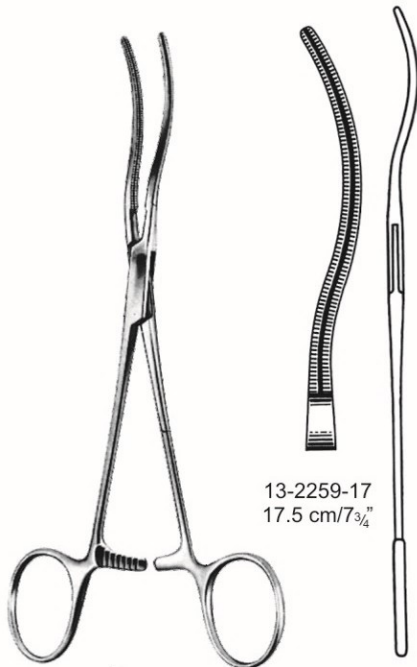

13-2259-17
17.5 cm/7 3/4"

Glover

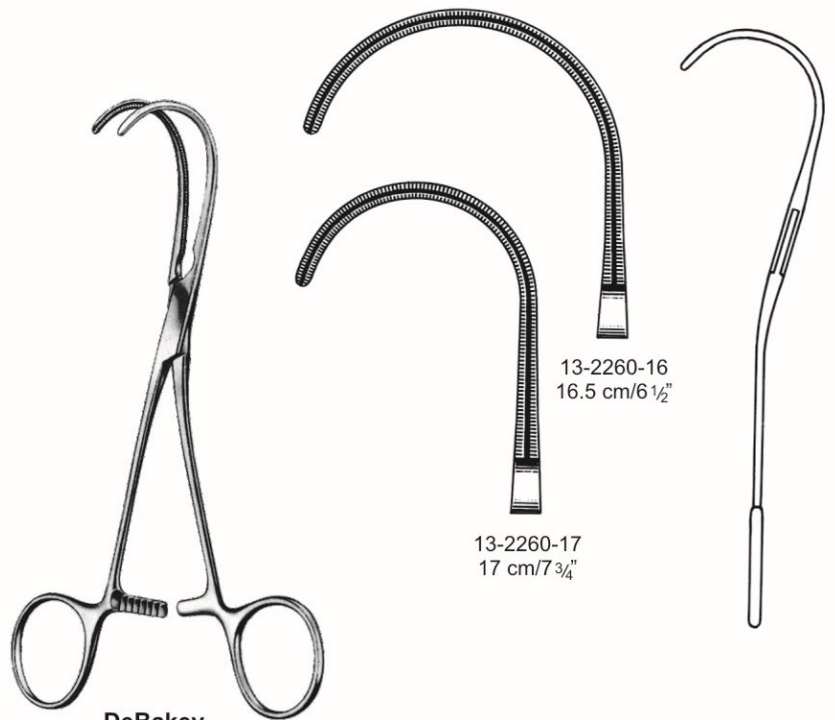

13-2260-16
16.5 cm/6 1/2"

13-2260-17
17 cm/7 3/4"

DeBakey

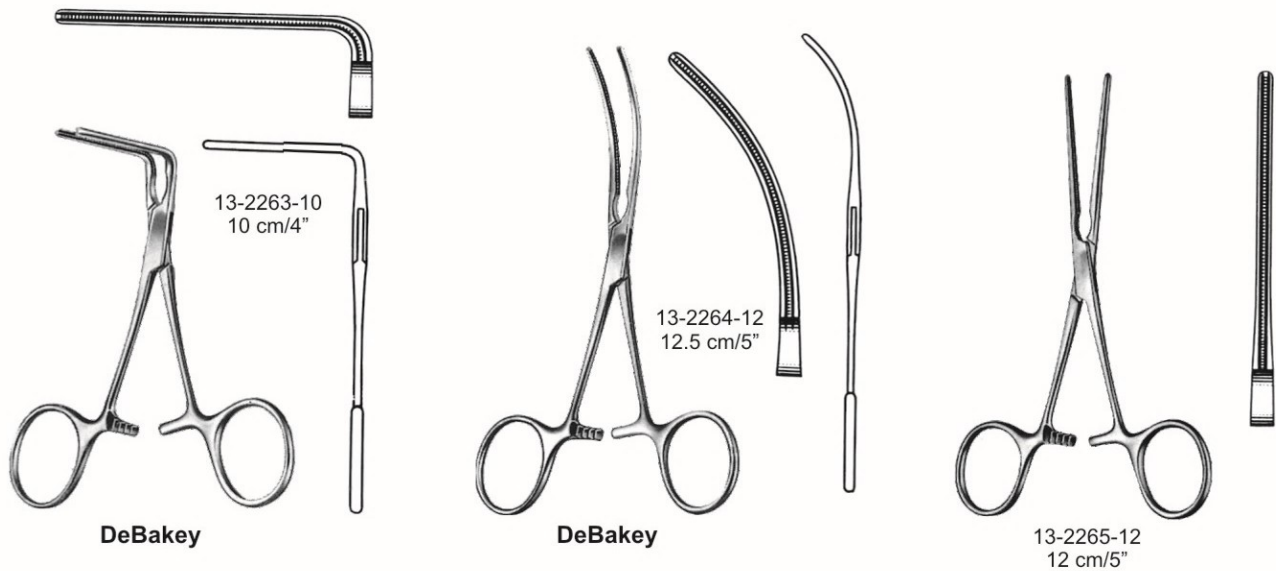
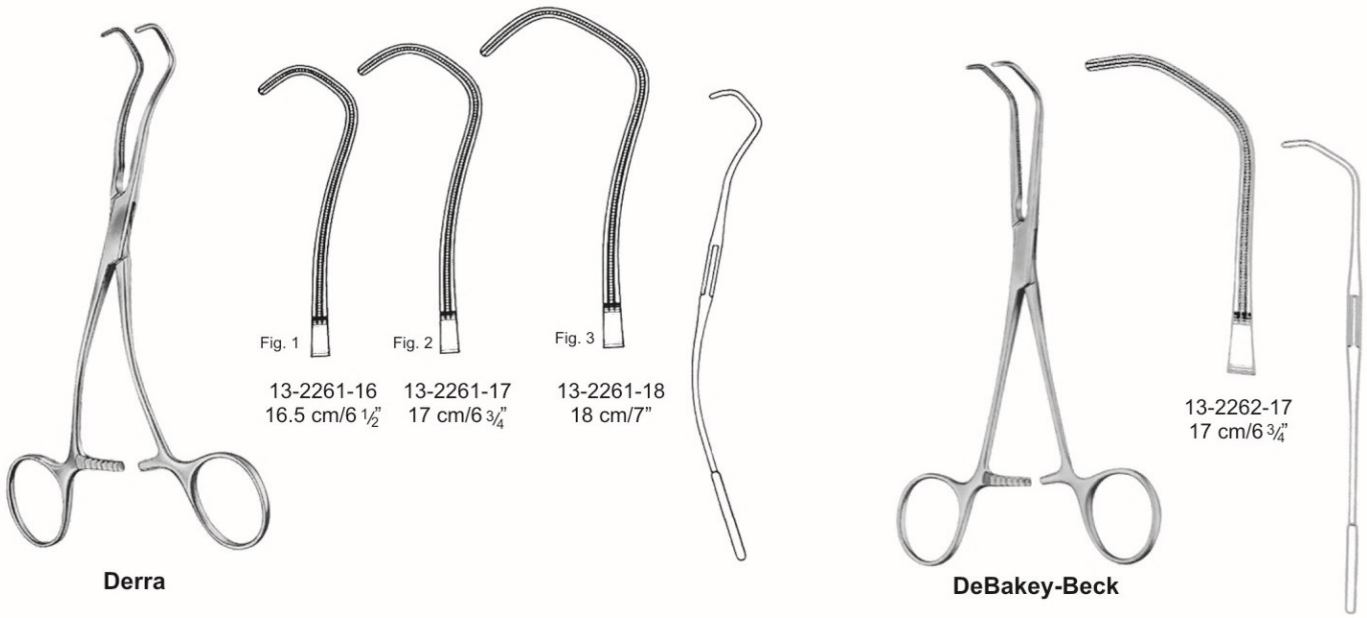

Cardiovascular Instruments

Pediatric Vascular Clamps
Pediatric Gefäßsklemmen

Pédiatriques clamps vasculaires
Pediátricos pinzas vasculares



DeBakey



13-2266-12
12.5 cm/5"



DeBakey

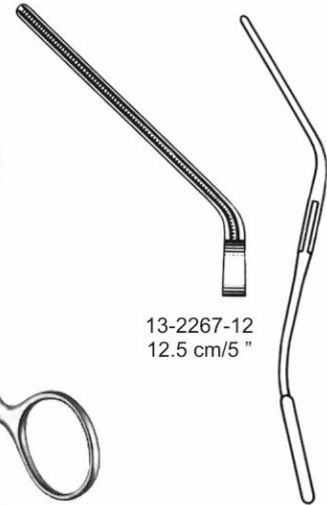

13-2267-12
12.5 cm/5"

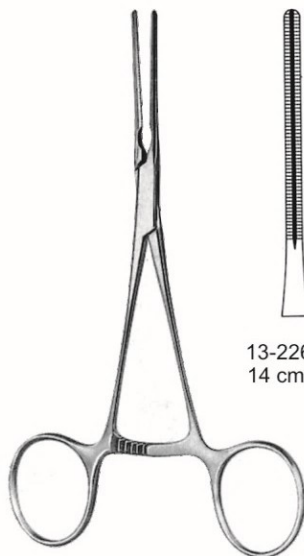

DeBakey

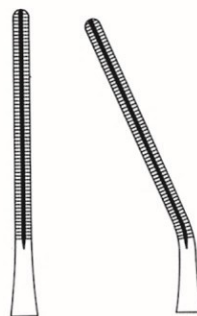

13-2268-01
14 cm/5 1/2"

13-2268-02
12.5 cm/5 3/4"



DeBakey

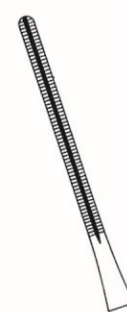

13-2269-03
12.5 cm/5 1/2"

Cardiovascular Instruments

Pediatric Vascular and Anastomosis Clamps
Pediatic Vascular Anastomose und Schellen

Vasculaire pédiatrique et pinces Anastomose
Vascular pediátrica y abrazaderas Anastomosis



13-2270-14
14 cm/5 1/2"

Cooley



Cooley
13-2271-14
14 cm/5 1/2"

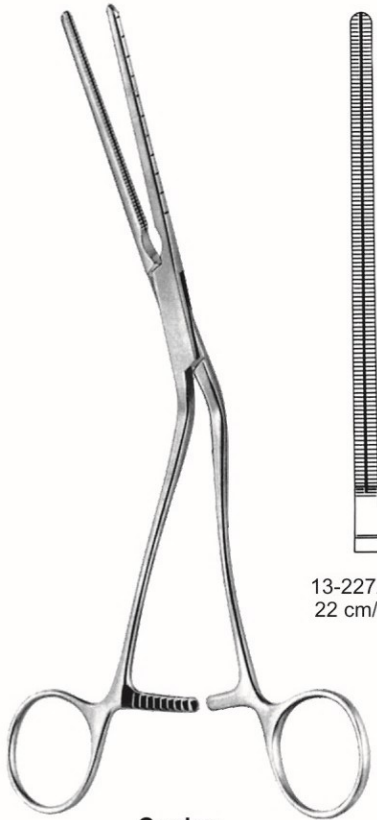

13-2272-22
22 cm/8 3/4"

**Cooley
Iliac Clamp**

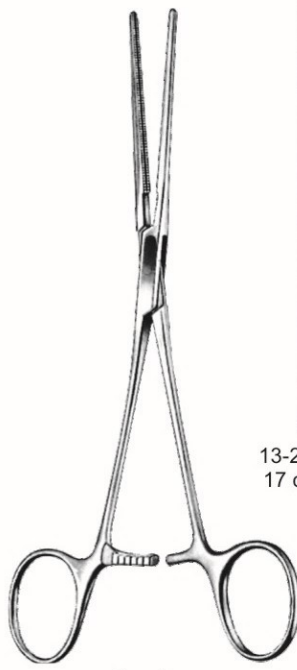

13-2273-17
17 cm/6 3/4"

Cooley

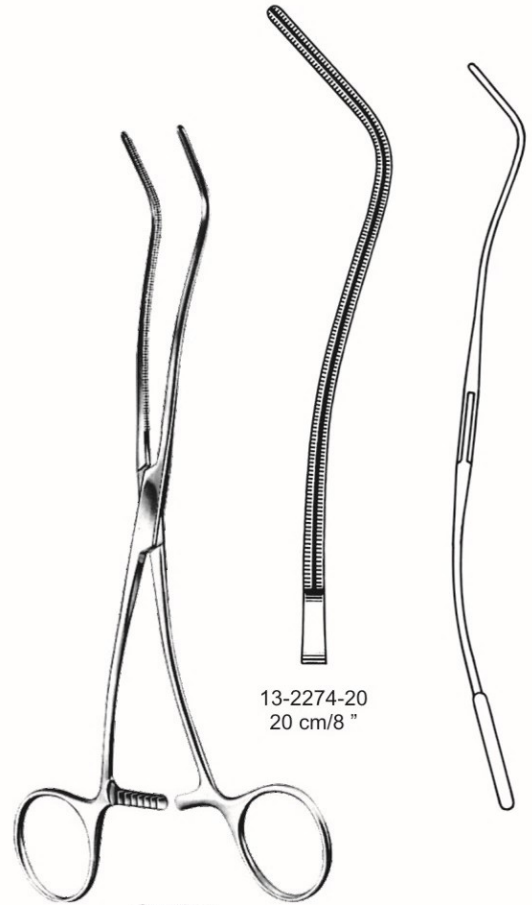

13-2274-20
20 cm/8"

Cooley

Cardiovascular Instruments

Anastomosis Clamps, Multi purpose Vascular Clamps
Anastomose Klemmen, Mehrzweck Gefäßklemmen

Pincas Anastomose, colliers multi usages vasculaires
Abrazaderas, Abrazaderas anastomosis vasculares multipropósito



Cooley

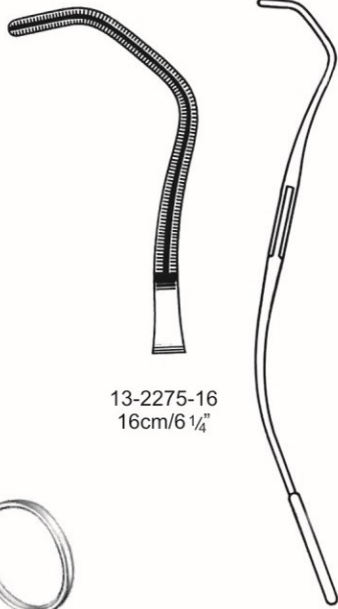

13-2275-16
16cm/6 1/4"



Cooley

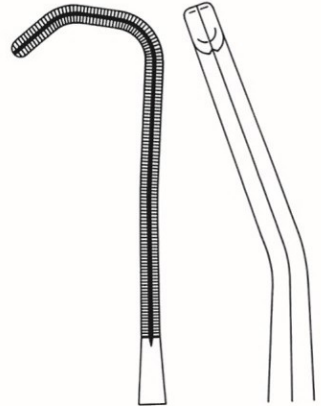

13-2276-16
16cm/5 1/4"



Cooley

13-2277-14
14cm/5 1/2"

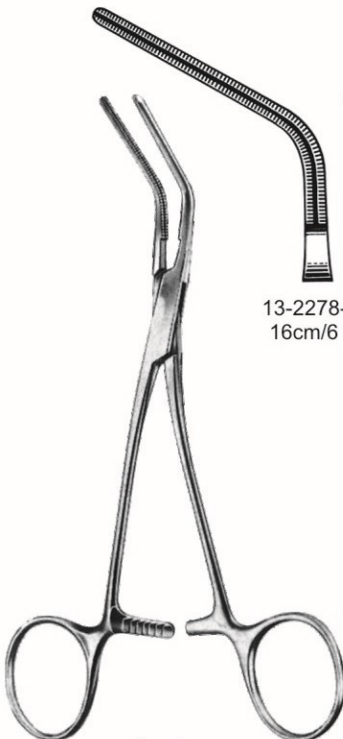

Cooley

13-2278-16
16cm/6 1/4"

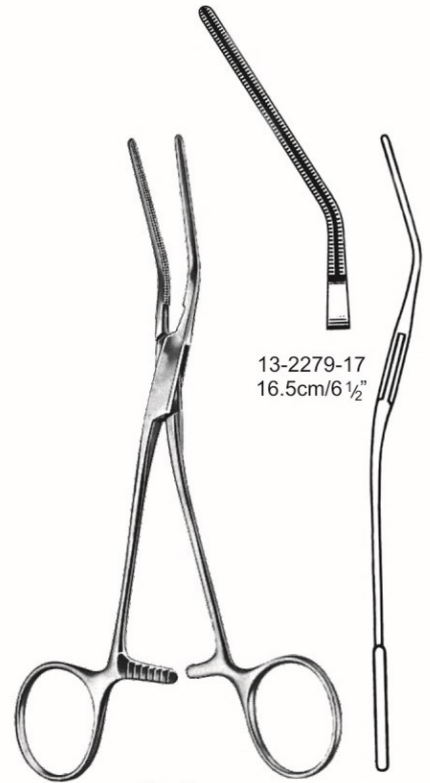

Cooley

13-2279-17
16.5cm/6 1/2"

Cardiovascular Instruments

Multi Purpose vascular Clamps
Multi Purpose Gefäßklemmen

Pinces Multi Purpose vasculaires
Pinzas Multiuso vasculares

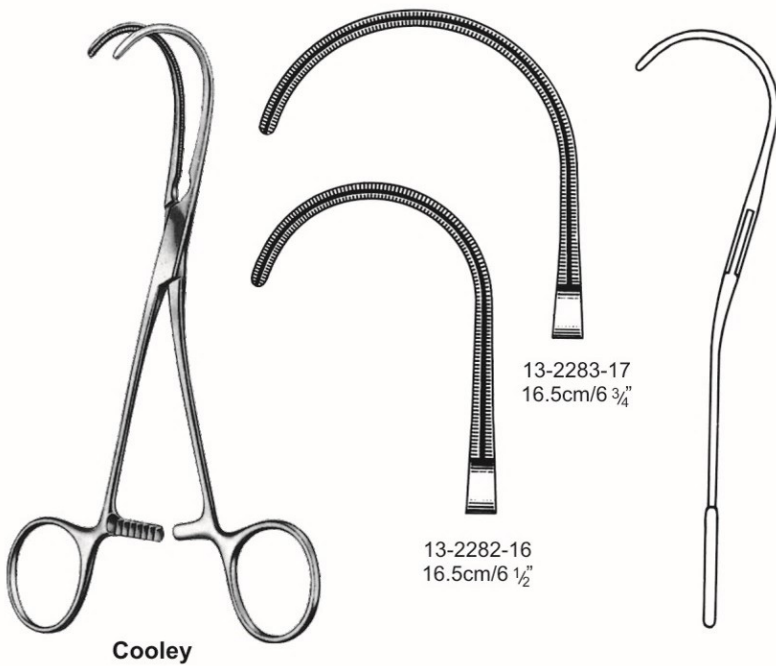

13-2283-17
16.5cm/6 3/4"

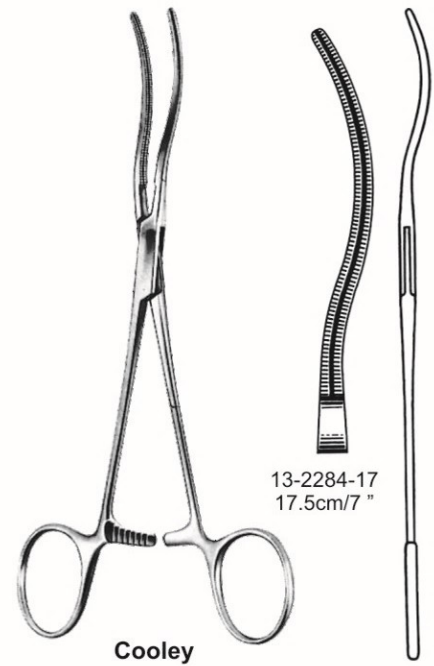

Cardiovascular Instruments

Multi Purpose vascular Clamps
Multi Purpose Gefäßklemmen

Pinces Multi Purpose vasculaires
Pinzas Multiuso vasculares



13-2285-16
16.5cm/7 1/2"

DeBakey



13-2286-16
16cm/7 1/4"

DeBakey

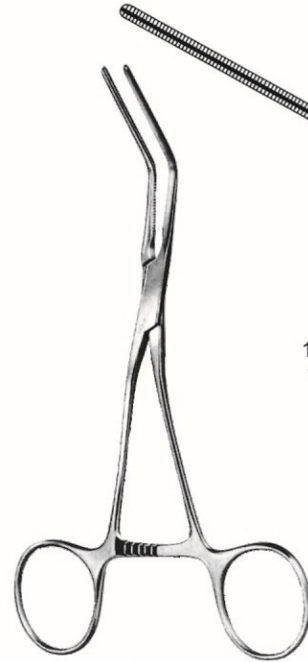

13-2287-16
15.5cm/6"

DeBakey



13-2288-16
15.5cm/6"

Cooley



13-2289-16
16cm/6"

Cooley

Cardiovascular Instruments

Neonatal and Pediatric Clamps
Neonatalogischen und pädiatrischen Schellen

Pinces néonatale et pédiatrique
Abrazaderas neonatal y pediátrica



Fig.



Fig.

Fig.	Straight gerade droit recto
1	13-2290-01
2	13-2290-02
3	13-2290-03
4	13-2290-04
5	13-2290-05
6	13-2290-06
7	13-2290-07
8	13-2290-08
9	13-2290-09



Fig.	Angled Anglé incliné angular
1	13-2291-01
2	13-2291-02
3	13-2291-03
4	13-2291-04
5	13-2291-05
6	13-2291-06
7	13-2291-07
8	13-2291-08
9	13-2291-09



Fig.	Curved Gebogene courbé Curvo
1	13-2292-01
2	13-2292-02
3	13-2292-03
4	13-2292-04
5	13-2292-05
6	13-2292-06
7	13-2292-07
8	13-2292-08
9	13-2292-09



Cardiovascular Instruments

Neonatal Vascular Clamps
Neonatal Gefäßklemmen

Néonatales clamps vasculaires
Neonatales pinzas vasculares



Castaneda

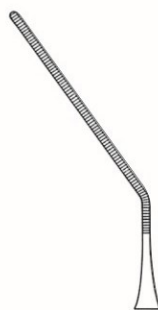

13-2293-01
12cm/5"

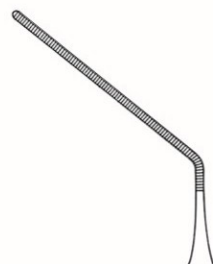

13-2293-02
11.5cm/4½"



13-2293-03
11cm/4¼"

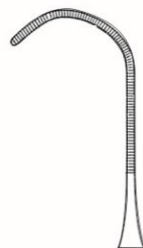

13-2294-01
11.5cm/4½"

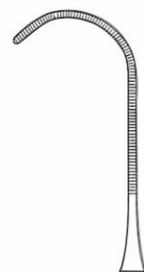

13-2294-02
12cm/4¾"



13-2294-03
12cm/4¾"

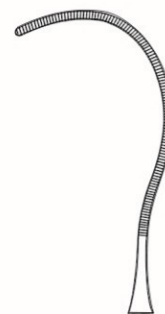

13-2294-04
12cm/4¾"



13-2295-18
18.5cm/7¼"

Intima Spatula

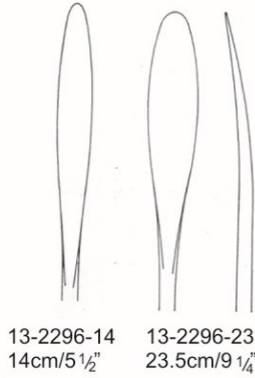

13-2296-14
14cm/5½"

13-2296-23
23.5cm/9¼"

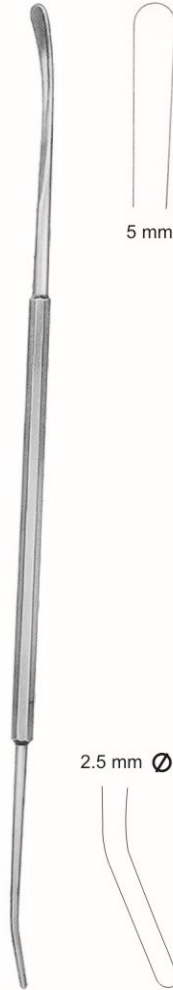

5 mm

2.5 mm Ø

Robb
13-2297-01
24cm/9½"
Fig. 1



4 mm

2.0 mm Ø

Robb
13-2297-02
24cm/9½"
Fig. 2

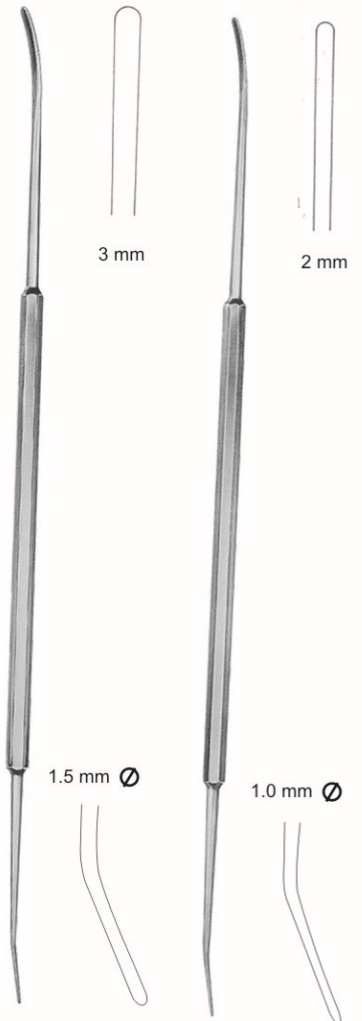

3 mm

2 mm

1.5 mm Ø

1.0 mm Ø

Robb
13-2297-03
24cm/9½"
Fig. 3

Robb
13-2297-04
24cm/9½"
Fig. 4

Cardiovascular Instruments

Nerve Hooklets, Toruniqetes
Nerve Håkchen, Toruniqetes

Petits crochets nerveuses, Toruniqetes
Ganchillos nerviosas, Toruniqetes

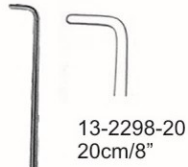

13-2298-20
20cm/8"

Crile



13-2299-20
20.5cm/8"

Crile



Ligature Catchers



13-2300-01
26cm/10 1/4"
1.5 mm



13-2300-02
26cm/10 1/4"
2.0 mm



13-2300-03
26cm/10 1/4"
2.5 mm



13-2300-04
26cm/10 1/4"
3.0 mm



Rumel-Belmont

13-2301-27
26cm/10 3/4"
3.0 mm Ø

13-2301-30
30.5cm/12"
6.4 mm Ø

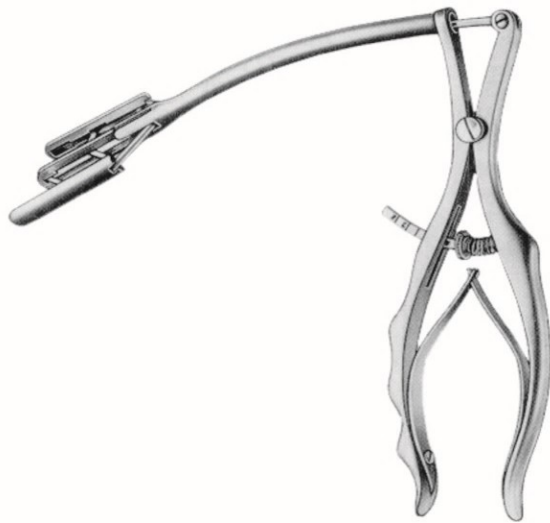

Cooley
13-2302-00



Gerbode
13-2303-00

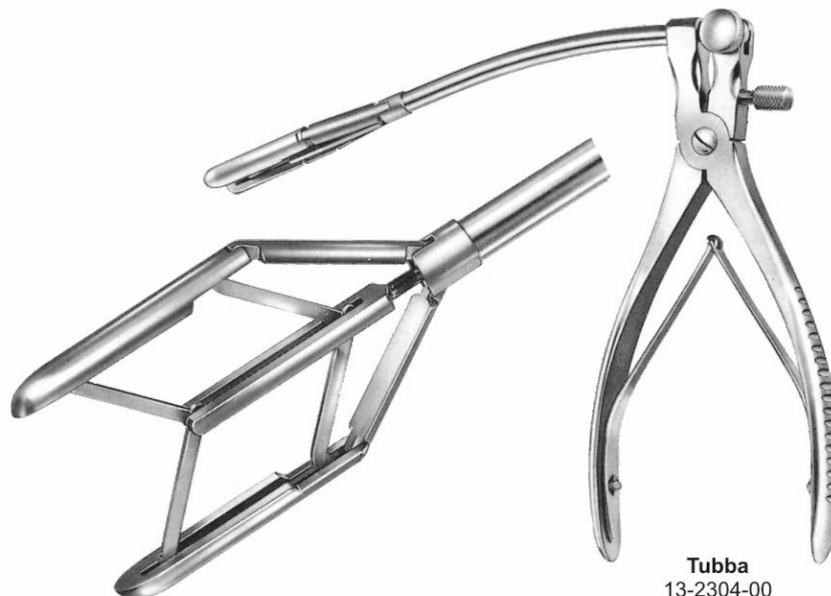

Tubba
13-2304-00

Neuro and Laminectomy Instruments

Instrument for Cerebral Opening
Instrument für Cerebral Eröffnung

Instrument concernant l'ouverture Cerebral
Instrument para la Apertura de Cerebral



Gigli
14-2305-00

Wire Saws
Seilsägen
Scies à fil
Sierras de cable



Gigli
14-2306-30 30 cm/12"
14-2306-40 40 cm/16"
14-2306-50 50 cm/20"

Conductors
Leiter
conducteurs
conductores



Martel
14-2307-33
33 cm/13"



Dahlgren
14-2308-20
20 cm/8"



With 2 Extra Hooks
Mit 2 Extra Haken
Avec 2 crochets supplémentaires
Con 2 ganchos adicionales

Skull Cutting Forceps
Schädel Cutting Forceps
Pince coupe de crâne
Pinzas de corte del cráneo



De Vilbiss
14-2309-21
21 cm/8 1/4"

With 1 Hook Each
Mit 1 pro Haken
Avec 1 crochet Chaque
Con un gancho Cada

Neuro and Laminectomy Instruments

Cervical Traction Tongs
Halswirbeltraktionsgerät Zange

Pince de traction cervicale
Pinzas de tracción cervical



14-2310-00



Crutchfield
14-2311-00

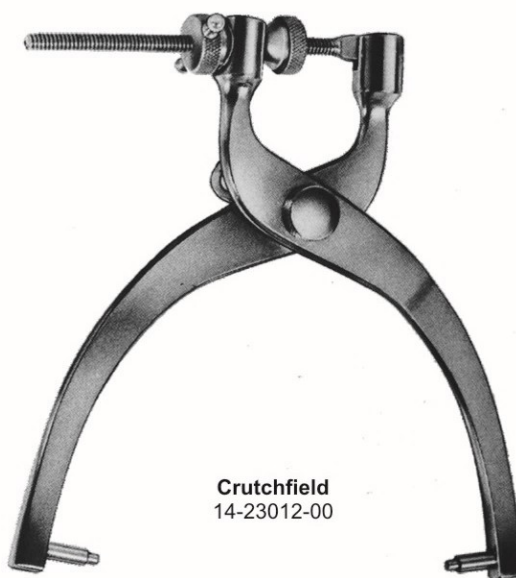

Crutchfield
14-23012-00

Neuro and Laminectomy Instruments

Instrument for Brain Suture
Instrument für Brain Suture

Instrument pour Suture cerveau
Instrument para la sutura del cerebro

Applying and Removing Forceps
Auftragen und Entfernen von Pinzetten
Application et suppression forceps
La aplicación de fórceps y extracción

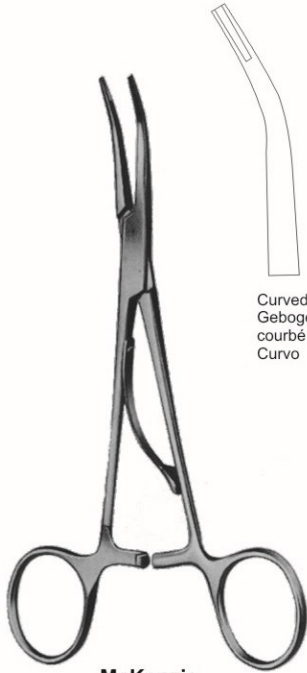

Curved
Gebogene
courbé
Curvo

McKenzie
14-2313-15 15 cm/6"
14-2313-19 19 cm/7½"



Straight
gerade
droit
recto

McKenzie
14-2314-15 15 cm/6"
14-2314-19 19 cm/7 "



Raney
14-2315-00
16 cm/6¼"



Olivecrona-Tonnis
14-2316-14

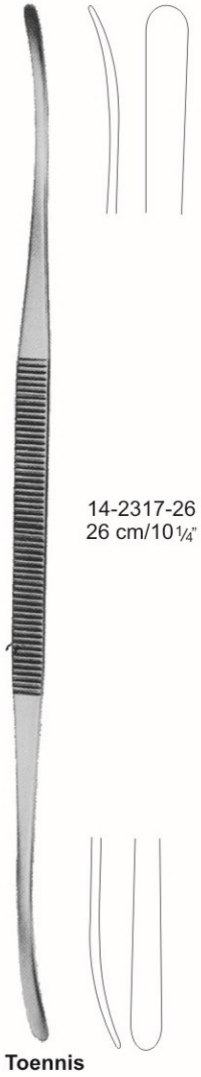

Neuro and Laminectomy Instruments

Dura Dissectors
harte Dissektoren

dissecteurs durs
dura disector

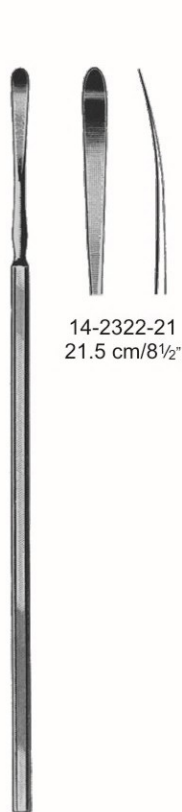

14-2322-21
21.5 cm/8½"

Davis

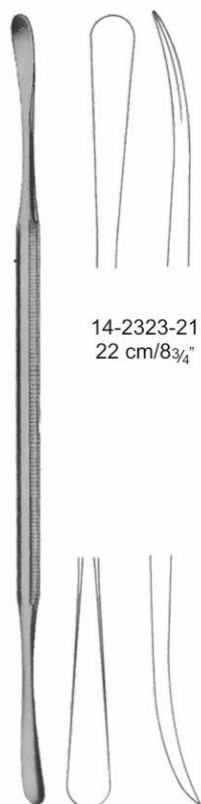

14-2323-21
22 cm/8¾"

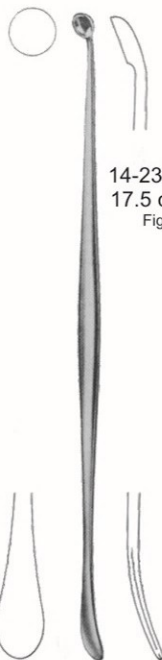

14-2324-01
17.5 cm/7"
Fig. 1

Penfield

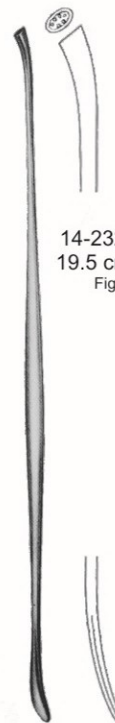

14-2325-02
19.5 cm/7¾"
Fig. 2

Penfield



14-2326-03
19.5 cm/7¾"
Fig. 3

Penfield



14-2327-04
20.5 cm/8"
Fig. 4

Penfield

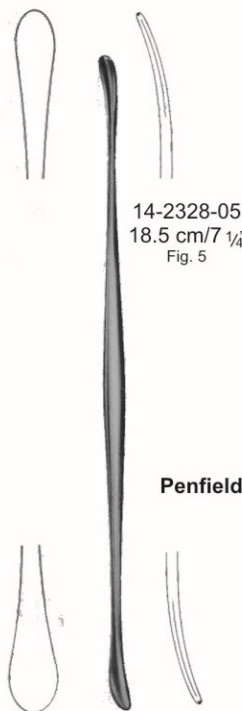

14-2328-05
18.5 cm/7¼"
Fig. 5

Penfield

Neuro and Laminectomy Instruments

Dura Dissectors, Nerve Root Retractors and Brain Spatulas
Dura Dissektoren, Nervenwurzel Retraktoren und Brain Spatel

Dissecteurs Dura, Rétracteurs racine nerveuse et Brain Spatules
Dura disectores, Retractores raíz del nervio y Espátulas cerebrales



14-2329-24
24.5 cm/9 3/4"



14-2330-21
21.5 cm/8 1/2"



14-2331-18
18 cm/7"



14-2332-11
11 cm/4 1/4"

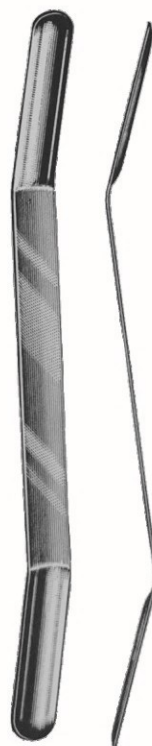

Upper end Lower end

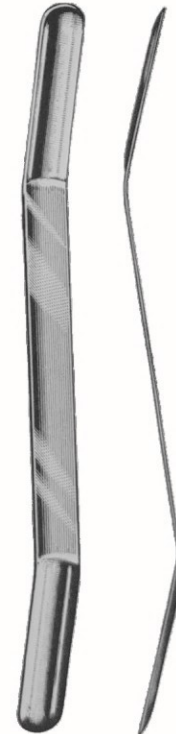

Olivecrona
18 cm/7"

Width of Spatulas
Breite Spatel
Largeur des Spatules
Ancho de espátulas

	Concave	mm	mm	Convex
	14-2333-01	7	9	14-2334-01
	14-2333-02	11	13	14-2334-02
	14-2333-03	15	18	14-2334-03
	14-2333-04	18	22	14-2334-04

Neuro and Laminectomy Instruments

Nerve Root Retractors
Nervenzurzel Retraktoren

Rétracteurs des racines nerveuses
Los retractoros de las raíces nerviosas

Accu-Med[®]
Instrument Co.



14-2335-23
23.5 cm/9 1/4"

scoville



14-2336-24
23.5 cm/9 1/4"

Holsher



14-2337-16
23.5 cm/9 1/2"

Scoviller

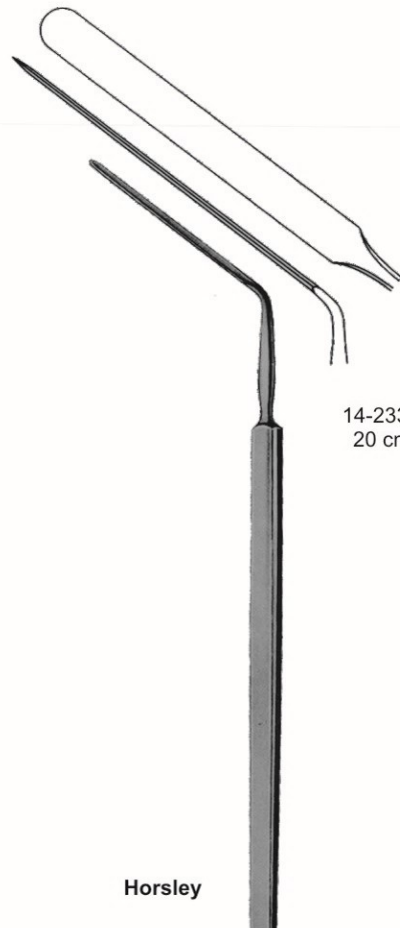

14-2338-20
20 cm/8"

Horsley



20 cm/8"
14 mm 14-2339-14
17 mm 14-2339-17
20 mm 14-2339-20



14-2340-21
21 cm/8 1/4"



14-2341-21
21 cm/8 1/4"

Sachs

Neuro and Laminectomy Instruments

Nerve Hooks
Nerve Haken

Crochets nerveuses
Ganchos nerviosas

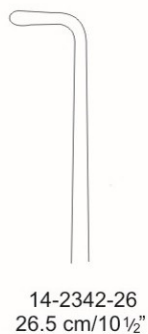

Groningen

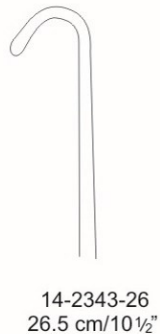

Smithwick



Cushing



14-2344-28
28 cm/11"
Fig. 2



Cushing



14-2345-28
28 cm/11"
Fig. 2



Dandy



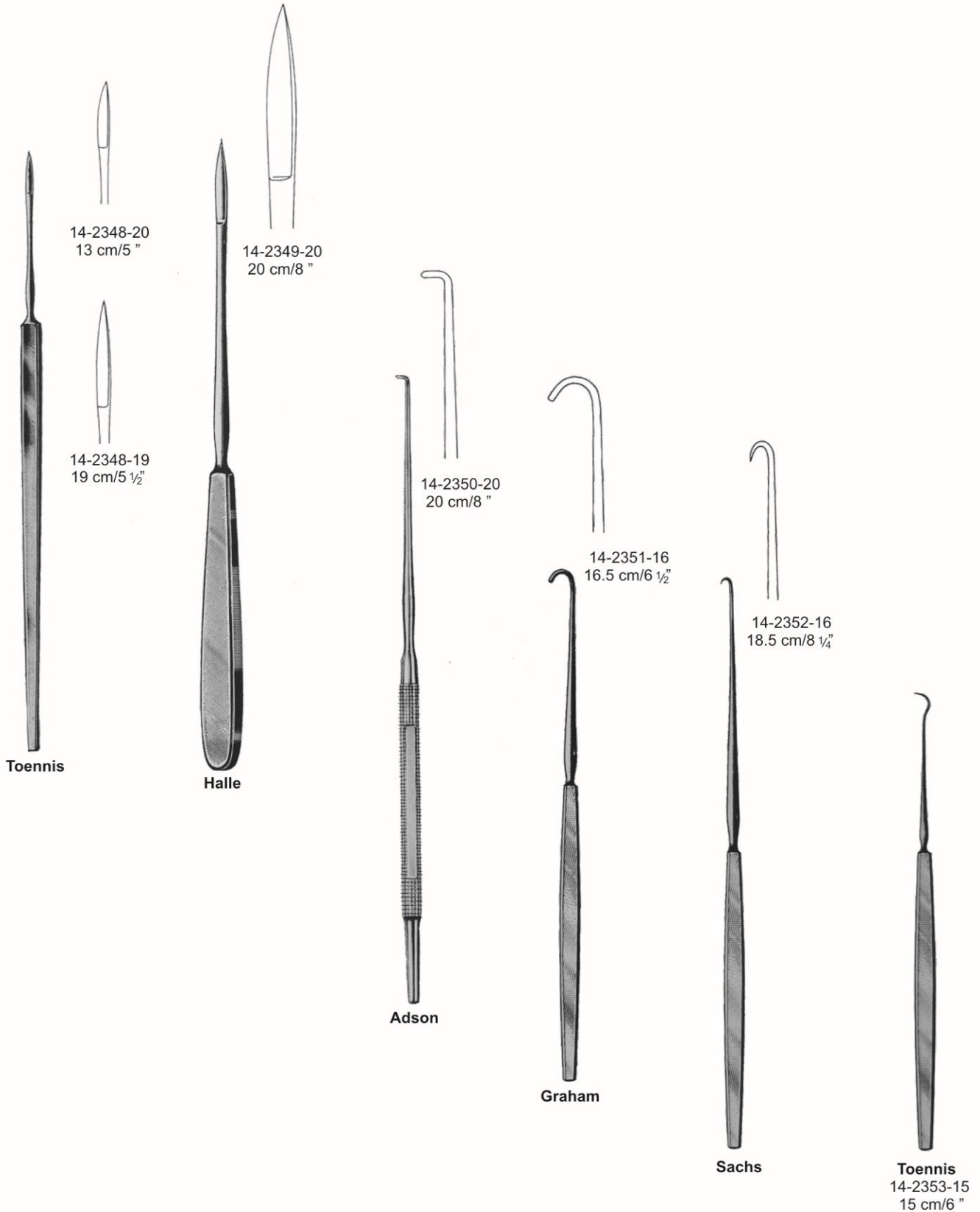

Neuro and Laminectomy Instruments

Blades for Lamina Spreaders
Klingen für Lamina Spreader

Lames pour Epageage Lamina
Cuchillas para Esparcidores Lamina

Lateral
seitlich
latérale
lateral



mm
14-2354-40 40 x 20
14-2354-45 45 x 20
14-2354-50 50 x 20
14-2354-55 55 x 20
14-2354-60 60 x 20



mm
14-2355-40 40 x 20
14-2355-45 45 x 20
14-2355-50 50 x 20
14-2355-55 55 x 20
14-2355-60 60 x 20



mm
14-2356-50 50 x 25
14-2356-60 60 x 25
Blunt Blades, For Taking
stumpfen Klingen, für die Aufnahme
Lames émoussées, pour prendre
Las cuchillas romas, para tomar

Medial
médian
medio



mm
14-2357-40 40 x 20
14-2357-45 45 x 20
14-2357-50 50 x 20
14-2357-55 55 x 20
14-2357-60 60 x 20

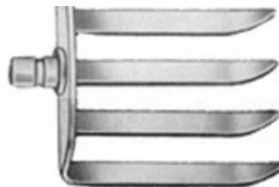

mm
14-2358-35 35 x 52
14-2358-40 40 x 52
14-2358-45 45 x 52
14-2358-50 50 x 52
14-2358-55 55 x 52
14-2358-60 60 x 52
14-2358-65 65 x 52
14-2358-70 70 x 52



mm
14-2359-35 35 x 37
14-2359-40 40 x 37
14-2359-45 45 x 37
14-2359-50 50 x 37
14-2359-55 55 x 37
14-2359-60 60 x 37
14-2359-65 65 x 37
14-2359-70 70 x 37



mm
14-2360-35 35 x 22
14-2360-40 40 x 22
14-2360-45 45 x 22
14-2360-50 50 x 22
14-2360-55 55 x 22
14-2360-60 60 x 22
14-2360-65 65 x 22
14-2360-70 70 x 22



mm
14-2361-50 50

Hook



mm
14-2362-70

Neuro and Laminectomy Instruments

Lamina Spreaders
Lamina Spreader

Epan dage lamina
Separadores de Lamina



Retractor Only
Retractor Nur
Seulement écarteur
Sólo Retractor
14-2363-01
12 cm/4¾"

Caspar
14-2363-00
14-2364-40
14-2365-40

Retractor Complete With 1 Blade Each
Retractor komplett mit 1 Klinge Jeder
Écarteur complet avec Chaque lame 1
Retractor completo con Cada una hoja

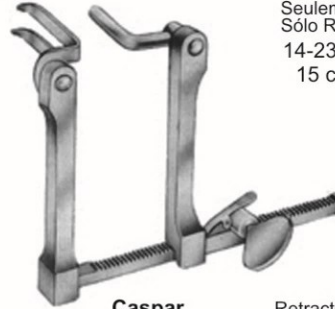

Retractor Only
Retractor Nur
Seulement écarteur
Sólo Retractor
14-2366-01
15 cm/6"

Caspar
14-2366-00
14-2367-40
14-2368-50

Retractor Complete With 1 Blade Each
Retractor komplett mit 1 Klinge Jeder
Écarteur complet avec Chaque lame 1
Retractor completo con Cada una hoja

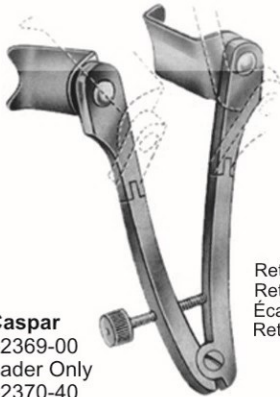

Spreader Only
Spreader Nur
épan deur seulement
Sólo Spreader
14-2369-01

Caspar
14-2369-00
Spreader Only
14-2370-40
14-2371-40

Retractor Complete With 1 Blade Each
Retractor komplett mit 1 Klinge Jeder
Écarteur complet avec Chaque lame 1
Retractor completo con Cada una hoja



Spreader Only
Spreader Nur
épan deur seulement
Sólo Spreader
14-2372-01

Caspar
14-2372-00
Retractor Only
Retractor Nur
Seulement écarteur
Sólo Retractor

Spreader Complete With 1 Blade Each
Spreader komplett mit 1 Klinge Jeder
Épan deur complet avec 1 Lame Chaque
Spreader completo con una cuchilla Cada
14-2373-45
14-2374-60

Retractor Only
Retractor Nur
Seulement écarteur
Sólo Retractor
14-2375-01
15 cm/6"

Caspar
14-2375-00
14-2376-45
14-2377-65

Retractor Complete With 1 Blade Each
Retractor komplett mit 1 Klinge Jeder
Écarteur complet avec Chaque lame 1
Retractor completo con Cada una hoja



Retractor Only
Retractor Nur
Seulement écarteur
Sólo Retractor
14-2378-01
15 cm/6"

Caspar
14-2378-00
14-2379-45
14-2379-65

Retractor adjustable, con 1 blade each
Retractor einstellbar, con 1 Klinge jedes
Écarteur réglable, con 1 lame à chaque
Separador ajustable, con una hoja cada

Neuro and Laminectomy Instruments

Lamina Spreaders
Lamina Spreader

Epan dage lamina
Separadores de Lamina



Cloward
14-2380-00
15 cm/6"

Complete with 5 blades
Komplett mit 5 Klingen
Livré avec 5 lames
Completo con 5 cuchillas

14-2380-01
Retractor Only
Retractor Nur
Seulement écarteur
Sólo Retractor



14-2381-01
Retractor Only
Retractor Nur
Seulement écarteur
Sólo Retractor

Cloward
14-2381-00
25 cm/10"

Complete with 5 blades
Komplett mit 5 Klingen
Livré avec 5 lames
Completo con 5 cuchillas



14-2380-40
15x40 mm



14-2380-45
15x45 mm



14-2380-50
15x50 mm



14-2380-55
15x55 mm

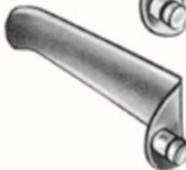

14-2380-60
15x60 mm



14-2381-40
15x40 mm



14-2381-45
15x45 mm



14-2381-50
15x50 mm



14-2381-55
15x55 mm

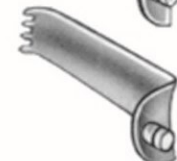

14-2381-60
15x60 mm

Neuro and Laminectomy Instruments

Lamina Spreaders
Lamina Spreader

Epandage lamina
Separadores de Lamina

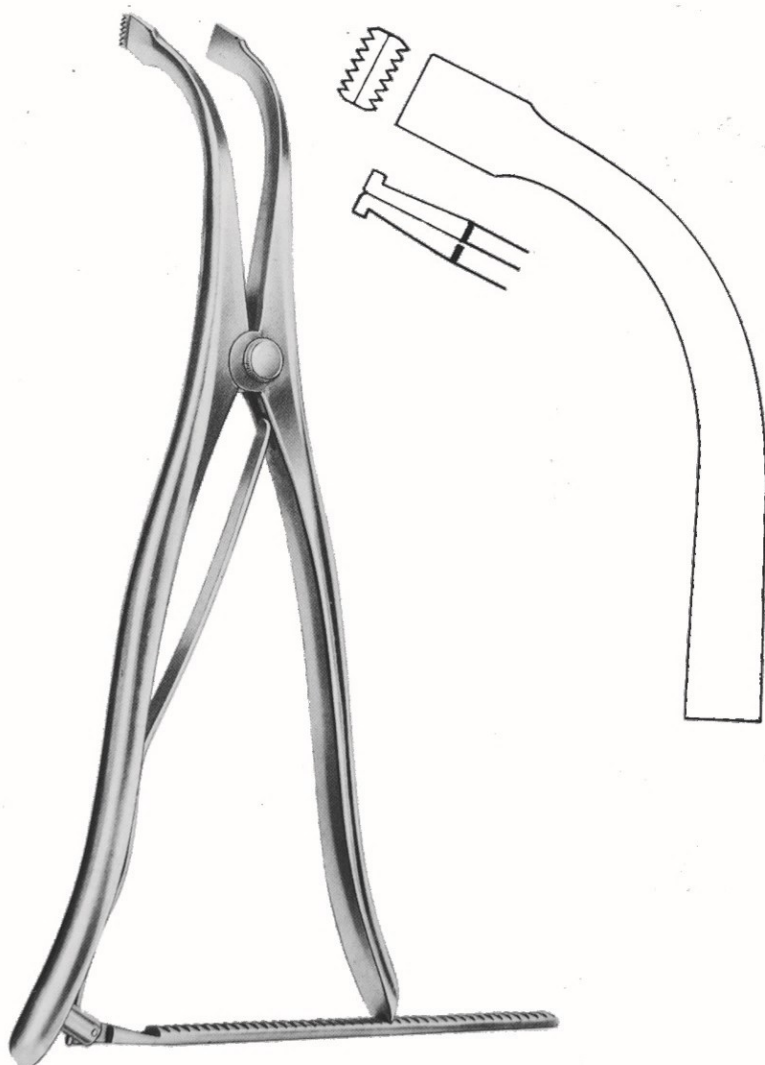

Inge
14-2382-27
27 cm/10¾"

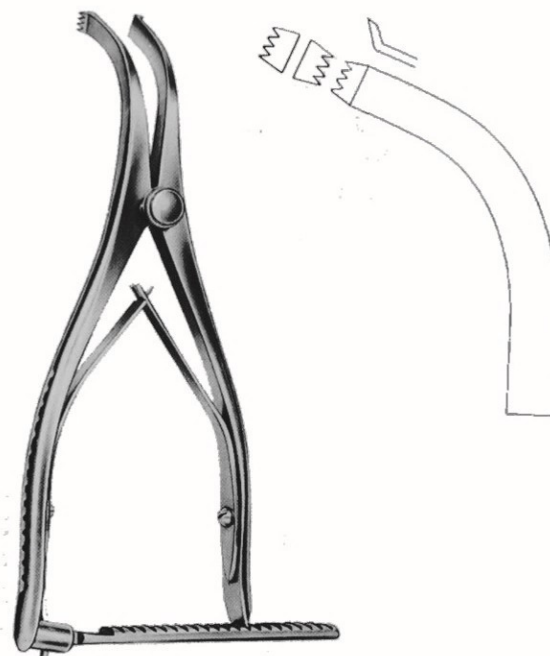

Inge
14-2383-16
16 cm/6¼"



Cloward
14-2384-16
16 cm/6¼"

Neuro and Laminectomy Instruments

Lamina Spreaders
Lamina Spreader

Epandage lamina
Separadores de Lamina



Frame
14-2385-01

Hey
14-2385-00
14-2386-00
23 cm/9"

Muscle blades
Muscle Klingen
lames musculaires
hojas musculares

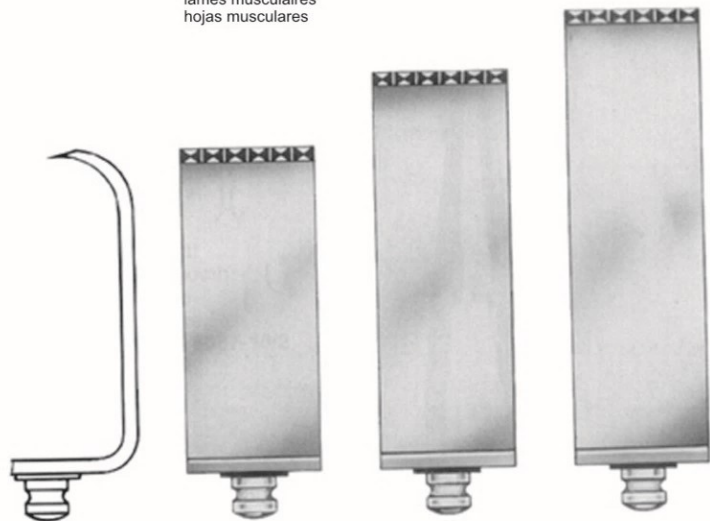

14-2385-50
20x50 mm

14-2385-60
20x60 mm

14-2385-70
20x70 mm

Vertebra-pins
Wirbel-pins
vertèbres broches
vértebras-pins



14-2386-50
50 mm

14-2386-60
60 mm

14-2386-70
70 mm

Neuro and Laminectomy Instruments

Lamina Spreaders
Lamina Spreader

Epan dage lamina
Separadores de Lamina

Left-type
Left-Typ
Gauche type
De tipo izquierdo



17 cm/6 3/4"

Right-type
Rechts-Typ
Droit de type
Haga tipo



17 cm/6 3/4"

Left-type
Left-Typ
Gauche type
De tipo izquierdo

Right-type
Rechts-Typ
Droit de type
Haga tipo

50x10 mm

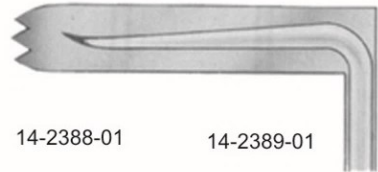

14-2388-01

14-2389-01

60x10 mm

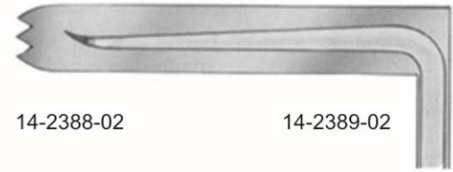

14-2388-02

14-2389-02

70x10 mm



14-2388-03

14-2389-03

50x20 mm

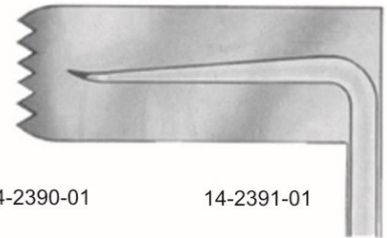

14-2390-01

14-2391-01

60x20 mm

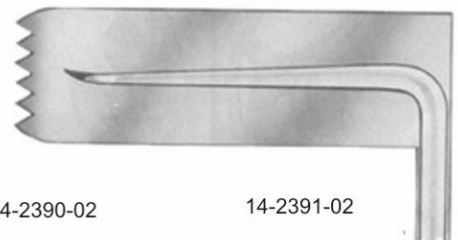

14-2390-02

14-2391-02

70x20 mm

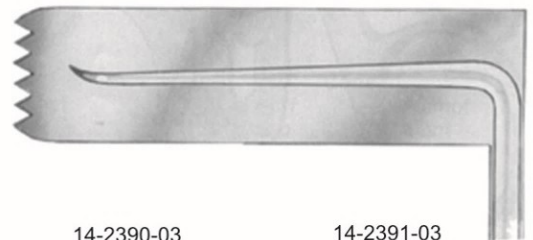

14-2390-03

14-2391-03

Neuro and Laminectomy Instruments

Muscle Retractors
Muscle Retraktoren

Rétracteurs musculaires
Los retractoros del músculo



Henly

Toothed

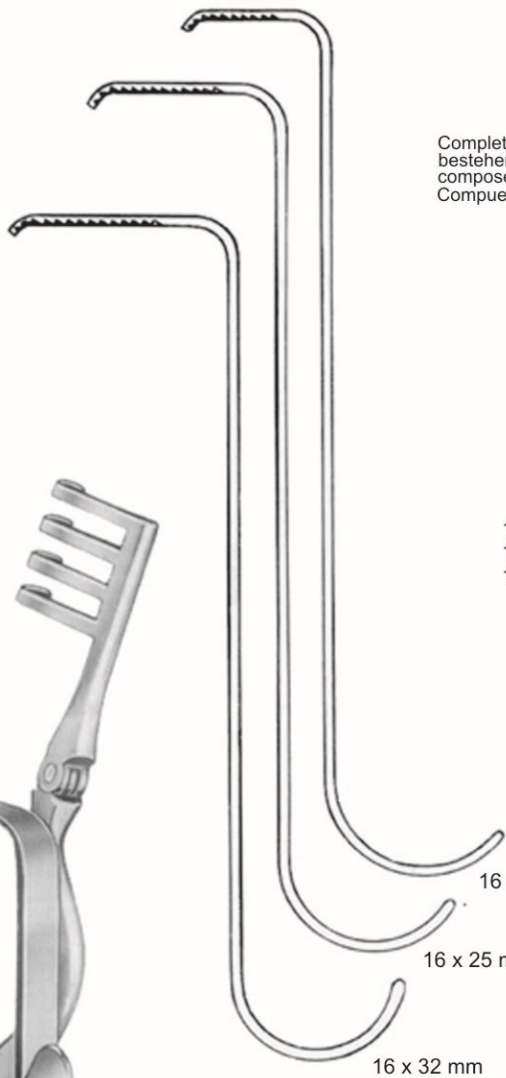

Complete Consisting of
bestehend aus vervollständigen
composée d' compléter
Compuesto por completar

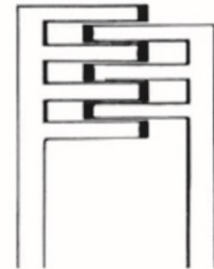

Standard

14-2392-00
14.5 cm/5¾"

14-2393-00
17 cm/6¾"

16 x 19 mm 14-2392-01
16 x 25 mm 14-2392-21
16 x 32 mm 14-2392-22
16 x 32 mm 14-2392-23

14-2393-01
14-2393-21
14-2393-22
14-2393-23

Frame
Centre Blades
Zentrum Blades
Lames Centre
Hojas Centro

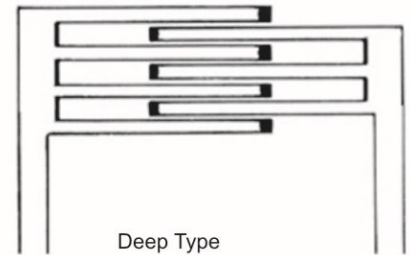

Deep Type

Complete Consisting of
bestehend aus vervollständigen
composée d' compléter
Compuesto por completar

14-2394-00 14-2395-00
14.5 cm/5¾" 17 cm/6¾"

14-2394-01
14-2394-21
14-2394-22
14-2394-23

14-2395-01
14-2395-21
14-2395-22
14-2395-23

Centre Blades
Zentrum Blades
Lames Centre
Hojas Centro

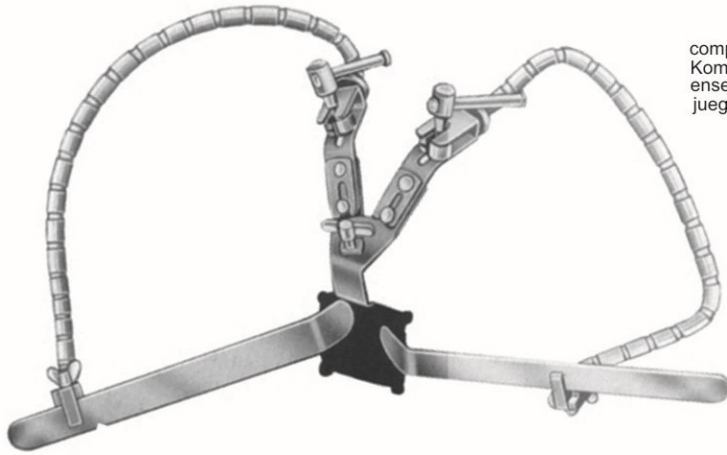

complete set
Komplett-Set
ensemble complet
juego completo

Yasargil
14-2396-00
2 14-2396-01
1 14-2396-02
2 14-2396-03

Self-retaining brain retractor, with 2 flexible arms, complete, consisting of:
Selbsthaltung Gehirn Retraktor mit 2 flexiblen Armen, komplett, bestehend aus:
Écarteur autostatique cerveau, avec 2 bras flexibles, complets, consistant en:
Auto-retención cerebro retractor, con 2 brazos flexibles y completos, que consiste en:

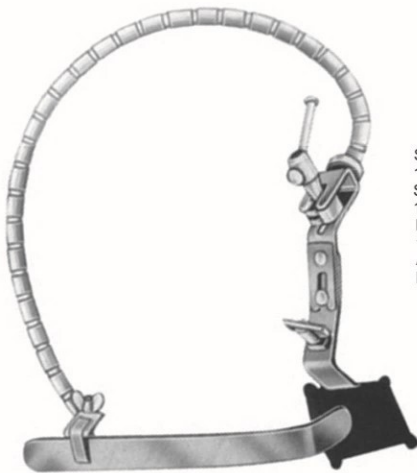

Yasargil complete set
14-2397-00 Komplett-Set
1 14-2397-01 ensemble complet
1 14-2397-02 juego completo
1 14-2397-10

Self-retaining brain retractor, with 1 flexible arm, complete, consisting of:
Selbsthaltung Gehirn Retraktor mit 1 flexiblen Arm, komplett, bestehend aus:
Écarteur autostatique cerveau, avec 1 bras flexible, complet, consistant en:
Auto-retención cerebro retractor, con un brazo flexible, completa, que consiste en:



14-2398-10
wire cable only
Draht-Kabel nur
câble métallique ne
alambre cable sólo



14-2398-01
Fixation base, for skull mounting, holding 1 flexible arm
Fixation Base, Schädel-Montage, Halten 1 flexiblen Arm
Base de fixation, pour le montage du crâne, détenant 1 bras flexible
Base de fijación, para el montaje del cráneo, la celebración de un brazo flexible



14-2398-02
Fixation base, for skull mounting, holding 2 flexible arms
Fixation Base, Schädel-Montage, Halten 2 flexiblen Armen
Base de fixation, pour le montage du crâne, n'excédant pas 2 bras flexibles
Base de fijación, para el montaje del cráneo, la celebración de dos brazos flexibles



14-2398-03
Support only, flat brain spatulas, Unterstützen nur, flache Gehirn Spatel, Prennent en charge que le cerveau, spatules plates, Apoyo espátulas, el cerebro sólo planos,



14-2398-04
Support only, for brain spatulas with round shaft up to 5,5 mm diam. Fixing for flexible
Unterstützt nur für Gehirn-Spatel mit runden Wellenenden bis 5,5 mm Durchmesser. Befestigung für flexible
Prennent uniquement en charge, pour spatules cerveau avec tige ronde jusqu'à 5,5 mm de diamètre. Fixation pour flexibles
Único apoyo, para espátulas cerebrales con eje redondo hasta un diámetro de 5,5 mm. La fijación de criterios flexibles

Neuro and Laminectomy Instruments

Intervertebral Disc Rongeurs
Inter Bandscheibe Rongeur

Rongeurs disques intervertébraux
Los roedores del disco intervertebral



Ferris-Smith-Kerrison

	Width of Bite Breite der Biss Largeur de Bite Ancho de Bite	Length of Shaft Länge der Welle Longueur de l'arbre Longitud del eje		
	15 cm/6"	20 cm/8"	18 cm/7"	
	0.6 mm		14-2401-00	
	1 mm		14-2401-01	
	2 mm		14-2401-02	
	3 mm	14-2399-03	14-2400-03	14-2401-03
	4 mm		14-2400-05	14-2401-04
5 mm	14-2399-05		14-2401-05	
			14-2404-00	
	0.6 mm		14-2404-01	
	1 mm		14-2404-02	
	2 mm		14-2404-03	
	3 mm	14-2402-03	14-2403-03	14-2404-03
	4 mm		14-2403-05	14-2404-04
5 mm	14-2402-05		14-2404-05	
			14-2407-00	
	0.6 mm		14-2407-01	
	1 mm		14-2407-02	
	2 mm		14-2407-03	
	3 mm	14-2405-03	14-2406-03	14-2407-03
	4 mm		14-2406-05	14-2407-04
5 mm	14-2405-05		14-2407-05	



Ferris-Smith-Kerrison

		Width of Bite Breite der Biss Largeur de Bête Ancho de Bite	15 cm/6"	20 cm/8"	18 cm/7"
Cutting Upward Schneiden nach oben couper vers le haut Cortar hacia arriba...		3 mm	14-2408-03	14-2409-03	14-2410-03
		5 mm	14-2408-05	14-2409-05	14-2410-05
Cutting Upward 40° Schneiden Upward 40° Couper vers le haut 40° Cortar hacia arriba 40°		3 mm	14-2411-03	14-2412-03	
		5 mm	14-2411-05	14-2412-05	
Cutting Downwards Schneiden Downwards En contrebas de coupe Hacia abajo de Corte		3 mm	14-2413-03	14-2414-03	14-2415-03
		5 mm	14-2413-05	14-2414-05	14-2415-05

Neuro and Laminectomy Instruments

Intervertebral Disc Rongeurs
Inter Bandscheibe Rongeur

Rongeurs disques intervertébraux
Los roedores del disco intervertebral



Schaftlänge Length of shaft Largo de vastago Schaftlänge Länge der Welle Largo de vastago Longueur de l'arbre Schaftlänge Largo vastago de Schaftlänge Longitud del eje Largo de vastago	150 mm 6"	190 mm 8"	150 mm 6"	190 mm 8"
Bißbreite Width of Bite Ancho de la boca Bißbreite Breite der Biss Ancho de la boca Largeur Bißbreite de Bite Ancho de boca la Ancho Bißbreite de Bite Ancho de la boca	3 mm	3 mm	5 mm	5mm
Art-Nr. Cat. Ref.	14-2416-03	14-2417-03	14-2418-06	14-2419-06

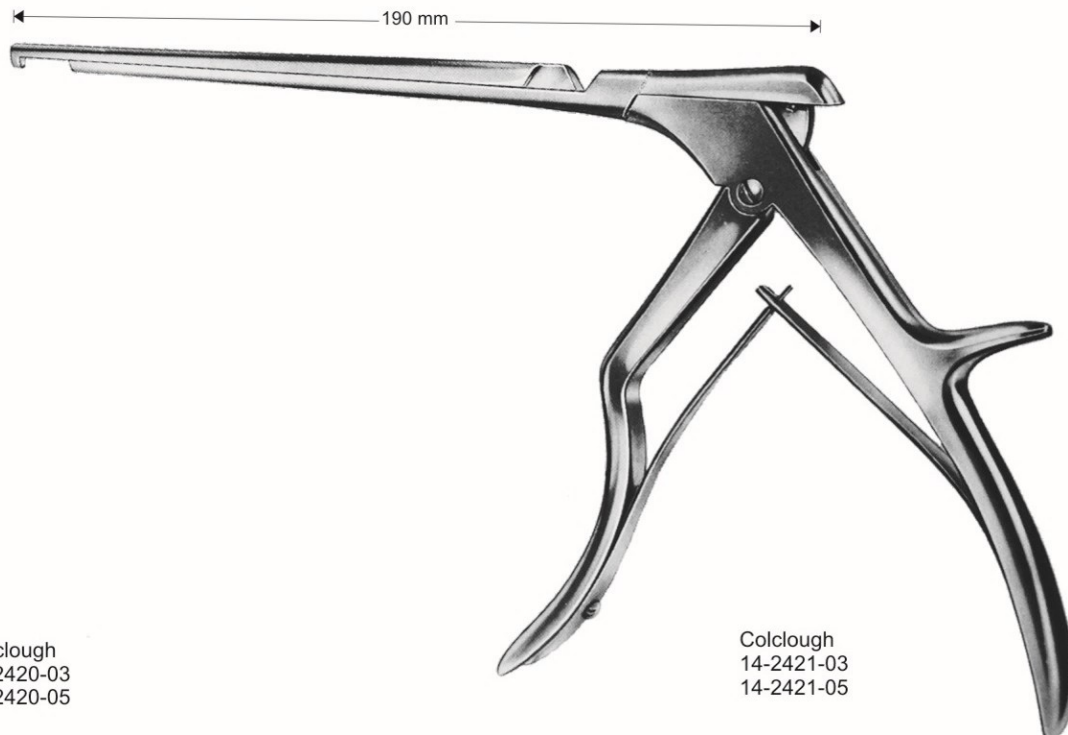

Colclough
14-2420-03
14-2420-05

Colclough
14-2421-03
14-2421-05



Ferris-Smith



Width Of Jaw
Width Of Jaw
Veulent consacrer la mâchoire
Width de la mandíbula

2 x 10 mm	14-2422-02	14-2423-02	14-2424-02
3 x 10 mm	14-2422-03	14-2423-03	14-2424-03
4 x 10 mm	14-2422-04	14-2423-04	14-2424-04

Neuro and Laminectomy Instruments

Laminectomy Rongeurs
Laminectomiestanzen

Rongeurs laminectomie
Rongeurs laminectomía

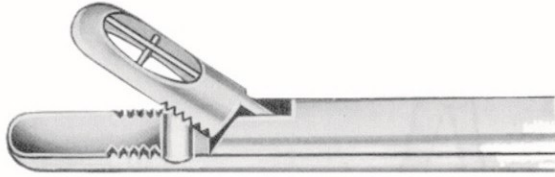

Serrated and Fenestrated Jaws
Serrated und Fenestrated Jaws...
Dentelé et Jaws fenêtrée
Dentada y mordazas fenestradas

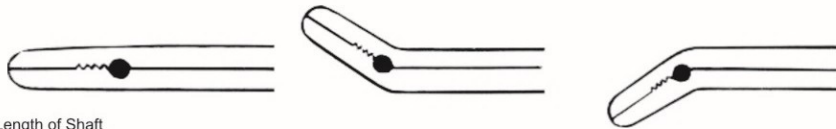

Width Of Jaw
Width Of Jaw
Veulent consacrer la mâchoire
Widh de la mandibula

Length of Shaft
Länge der Welle
Longueur de l'arbre
Longitud del eje

Width Of Jaw	Length of Shaft			
mm	14 cm/5 1/2"	14-2425-01	14-2425-02	14-2425-03
	16 cm/6 1/4"	14-2426-01	14-2426-02	14-2426-03
2 x 12	14 cm/5 1/2"	14-2427-01	14-2427-02	14-2427-03
	16 cm/6 1/4"	14-2428-01	14-2428-02	14-2428-03
3 x 12	14 cm/5 1/2"	14-2429-01	14-2429-02	14-2429-03
	16 cm/6 1/4"	14-2430-01	14-2430-02	14-2430-03
4 x 14	14 cm/5 1/2"	14-2431-01	14-2431-02	14-2431-03
	16 cm/6 1/4"	14-2432-01	14-2432-02	14-2432-03
5 x 14	14 cm/5 1/2"	14-2433-01	14-2433-02	14-2433-03
	16 cm/6 1/4"	14-2434-01	14-2434-02	14-2434-03
6 x 16	14 cm/5 1/2"			
	16 cm/6 1/4"			

Neuro and Laminectomy Instruments

Laminectomy Rongeurs
Laminektomiestanzen

Rongeurs laminectomie
Rongeurs laminectomia



14-2435-01
5 x 4 mm



14-2435-02
5 x 4 mm



14-2435-03
5 x 3.5 mm



14-2435-04
5 x 3.5 mm

Hajek
(Hajek-Kofler)
14 cm/5½"

360° Turnable
360° Drehbare
360° Turnable
360° Turnable

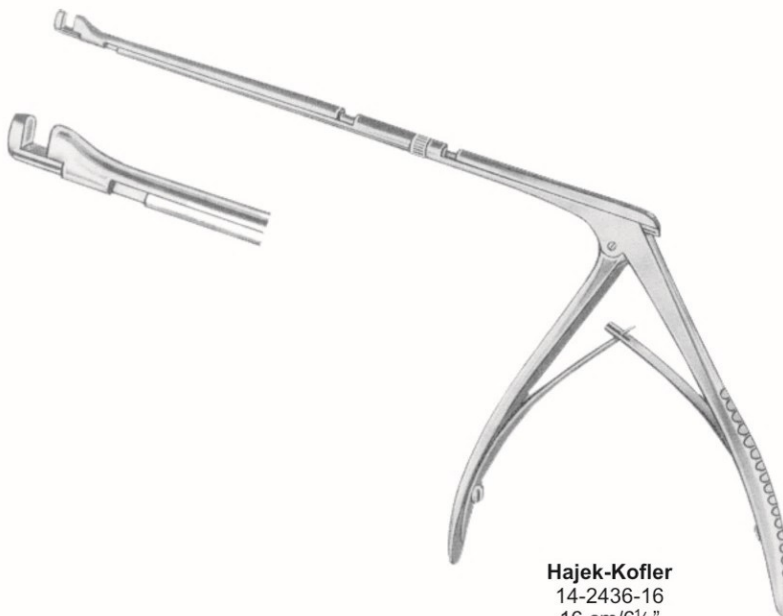

Hajek-Kofler
14-2436-16
16 cm/6½"

Neuro and Laminectomy Instruments

Laminectomy Rongeurs
Laminektomiestanzen

Rongeurs laminectomie
Rongeurs laminectomía

Ø 6.5 mm

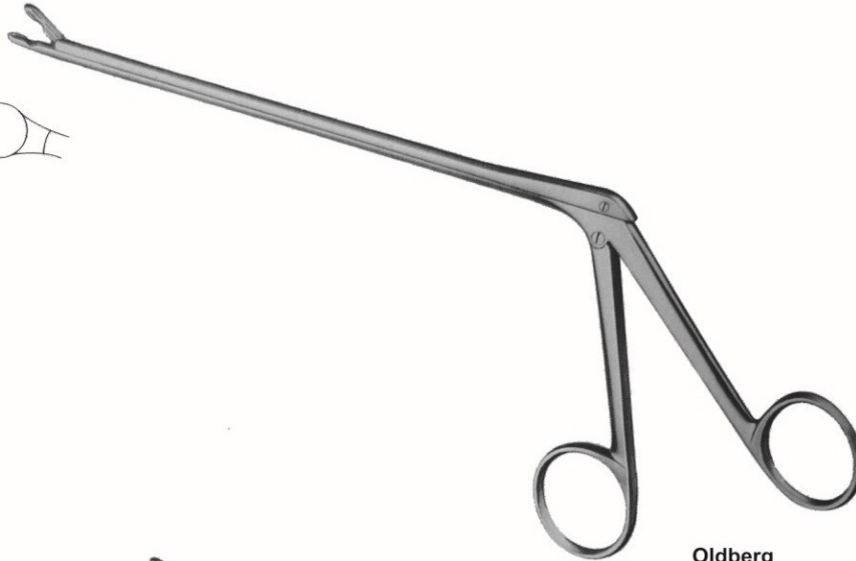

Oldberg
14-2437-65
18 cm/7"

Ø 3.5 mm



Yasargil
14-2438-19
19.5 cm/7¾"

Ø 9 mm

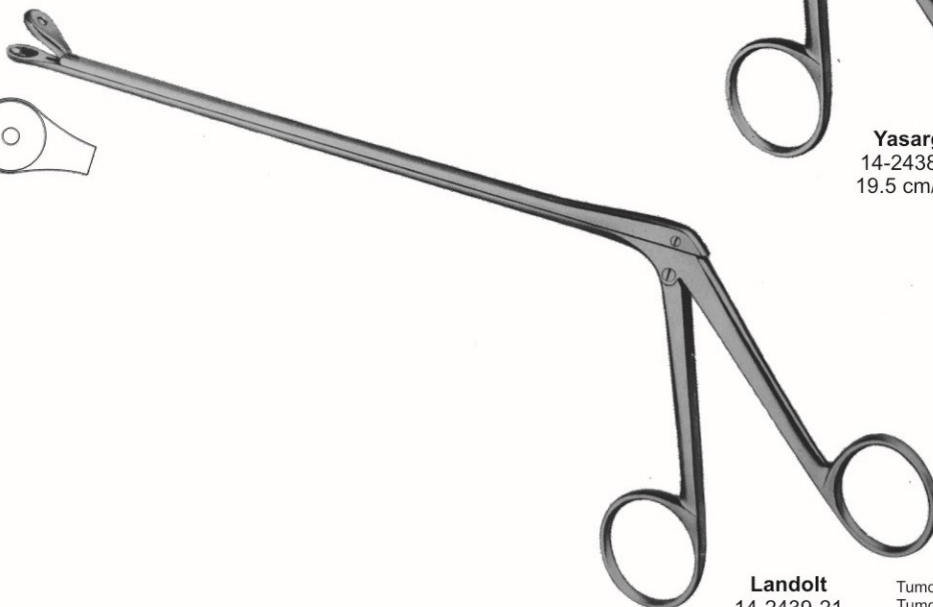

Landolt
14-2439-21
21 cm/8¼"

Tumor Grasping Forceps Blunt
Tumor Faßzange Blunt
Tumeur pince à préhension Blunt
Tumor Entender Pinzas Blunt