

Scheme of Dimensions for Specula

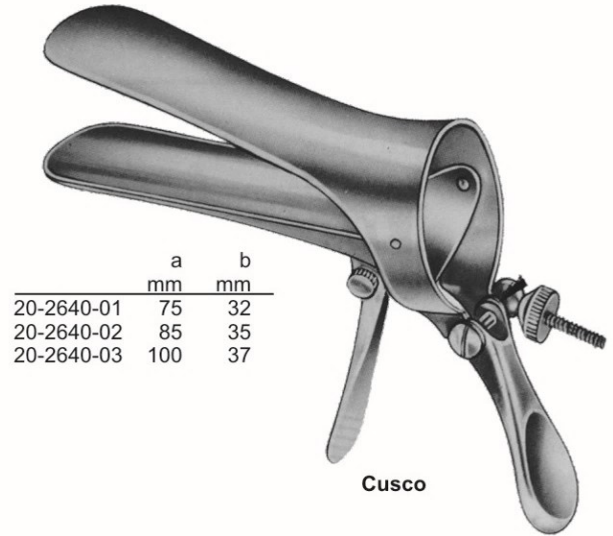

Cusco

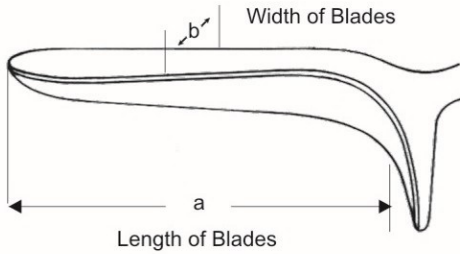
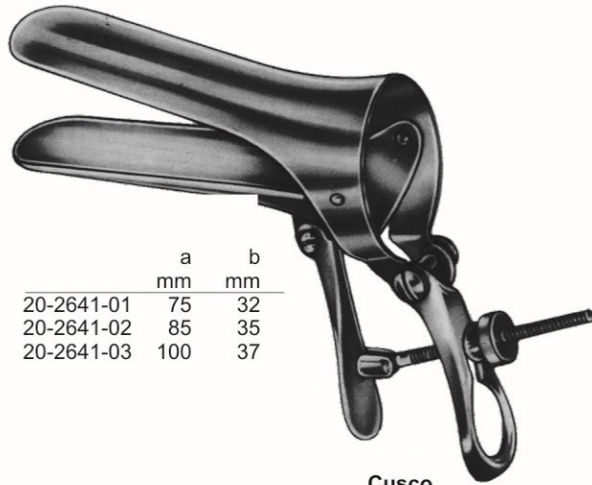

Cusco

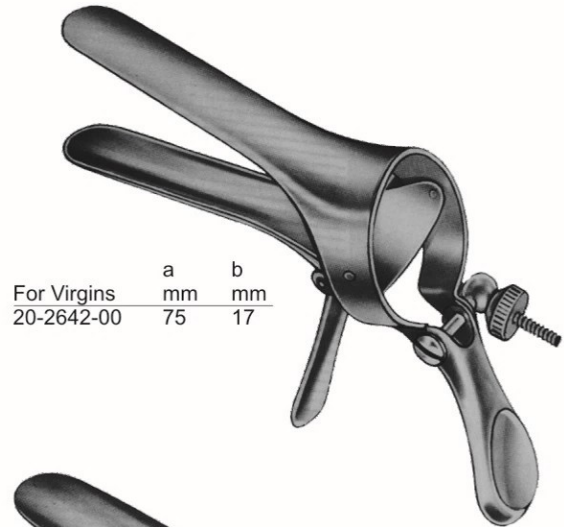

Cusco



Cusco

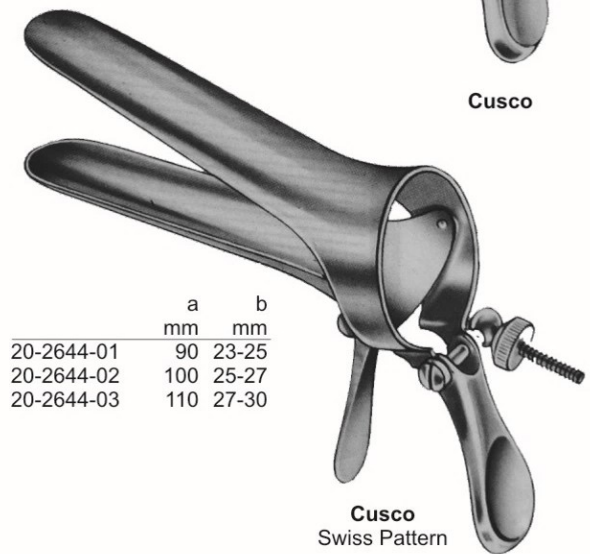

Cusco  
Swiss Pattern

# Gynecology Instruments

Vaginal Speculas  
Vaginal Speculas

Speculas vaginales  
especulos vaginales

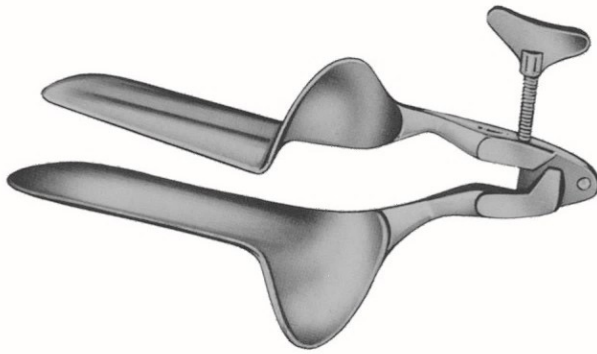

**Collin-Landau**

	a	b
	mm	mm
20-2645-01	85	30
20-2645-02	100	35
20-2645-03	110	40

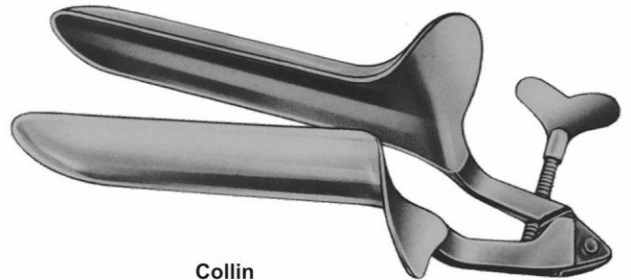

**Collin**

	a	b
	mm	mm
20-2646-01	85	30
20-2646-02	100	35
20-2646-03	110	40

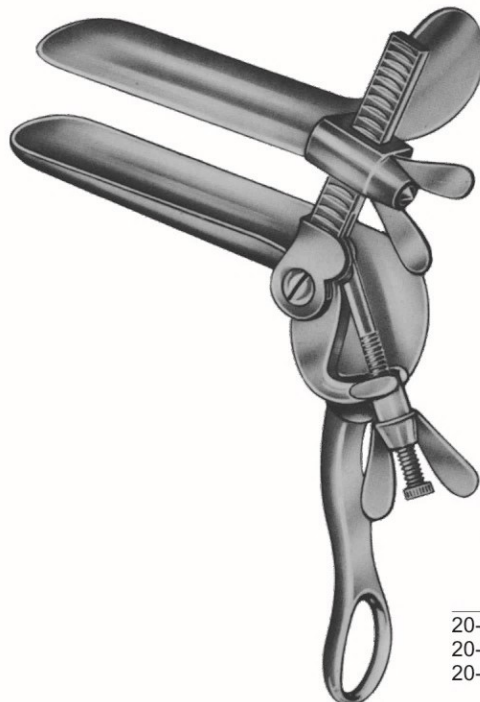

**Trelat**

	a	b
	mm	mm
20-2647-01	85	33
20-2647-02	95	35
20-2647-03	115	43

## Gynecology Instruments

Vaginal Speculas For Laser Surgery  
Vaginal Speculas Für Laser-Chirurgie

Speculas vaginaux pour la chirurgie laser  
Especulos vaginales para la cirugía láser



**Grave (Standard)**

	a mm	b mm
20-2648-01	75	20
20-2648-02	95	30
20-2648-03	115	35
20-2648-04	125	35

**Black**



<b>Grave</b>	a mm	b mm
20-2649-01	75	20
20-2649-02	95	30
20-2649-03	115	35

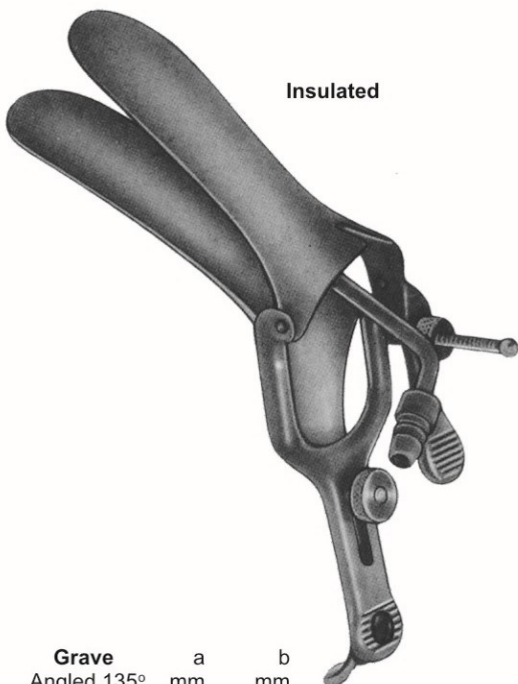

**Insulated**

<b>Grave</b>	a mm	b mm
Angled 135° 20-2650-00	101	35

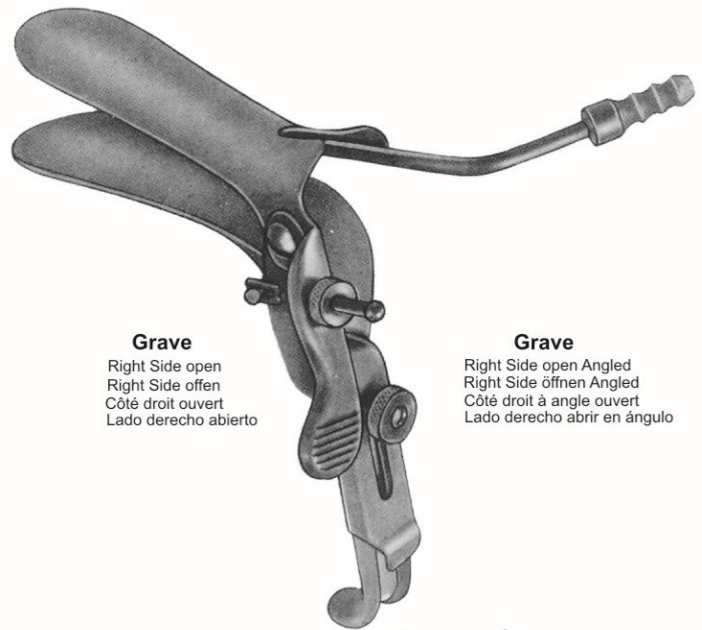

**Grave**

Right Side open  
Right Side offen  
Côté droit ouvert  
Lado derecho abierto

**Grave**

Right Side open Angled  
Right Side öffnen Angled  
Côté droit à angle ouvert  
Lado derecho abrir en ángulo

	a mm	b mm
20-2651-01	101	35
20-2651-02	101	35

# Gynecology Instruments

Vaginal Speculas  
Vaginal Speculas

Speculas vaginales  
espéculos vaginales

Lateral Specula

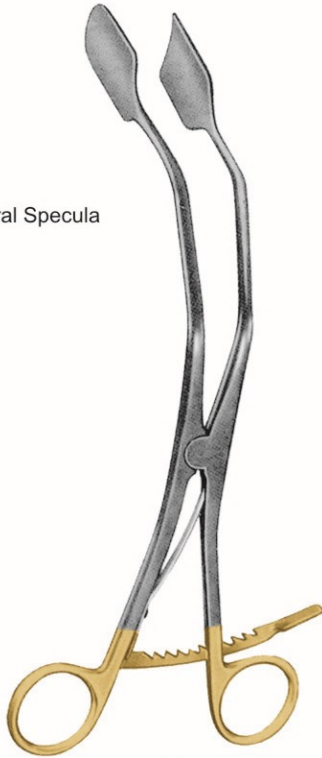

20-2652-00



Pederson	a mm	b mm
20-2653-01	75	13
20-2653-02	100	22
20-2653-03	120	25

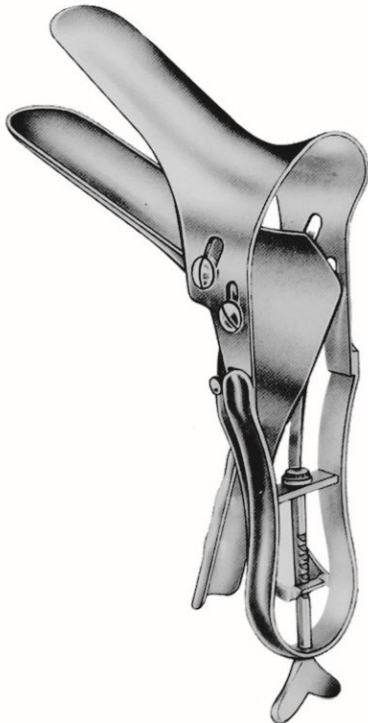

Sayfert	a mm	b mm
20-2654-01	100	17
20-2654-02	1010	33

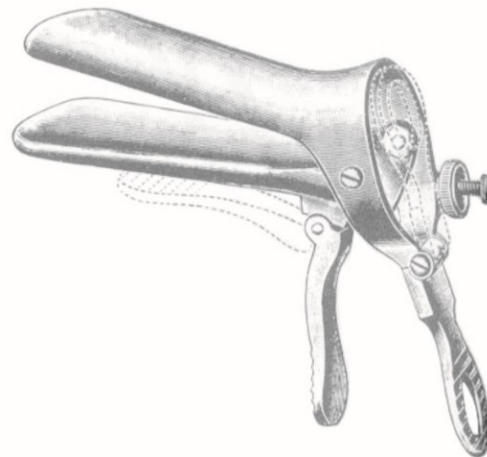

20-2655-01	small, klein, petit, pequeño
20-2655-02	medium, medeum, medeum
20-2655-03	large, groß, grand, grande

Scheme of Dimensions for Specula  
Schema Abmessungen für Spekula  
Schéma des dimensions de spéculums  
Esquema de Medidas para espéculos

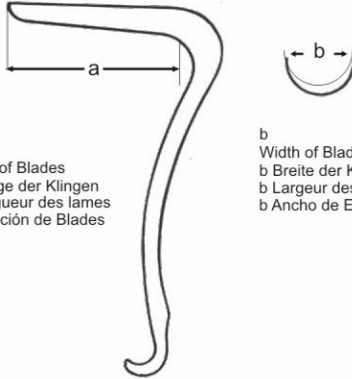

a  
Length of Blades  
ein Länge der Klängen  
un Longueur des lames  
un Duración de Blades

b  
Width of Blades  
b Breite der Klängen  
b Largeur des lames  
b Ancho de Espadas



**Sims**

20-2656-01	63 x 32 mm
20-2656-02	76 x 32 mm
20-2656-03	89 x 38 mm

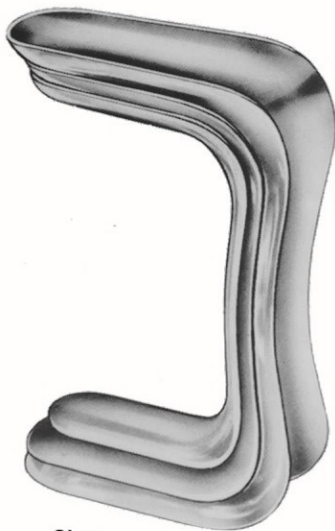

**Sims**

	Fig	a mm	b mm
20-2657-00			
20-2657-01	1	60	25+30
20-2657-02	2	70	30+35
20-2657-03	3	80	35+40



**Jackson**

	Fig.	a mm	b mm
	Fig.1	75 x 35	20-2658-01
	Fig. 2	90 x 35	20-2658-02
	Fig. 3	100 x 35	20-2658-03
20-2658-04	4	75 X 40	
20-2658-05	5	90 X 40	
20-2658-06	6	100 X 40	

# Gynecology Instruments

Vaginal Speculas  
Vaginal Speculas

Speculas vaginales  
especulos vaginales



**Eastman**

	Fig.	a mm	b mm
20-2659-01	1	76	38
20-2659-02	2	89	38
20-2659-03	3	101	38



For children  
für Kinder  
pour les enfants  
Para los niños

Set  
setzen  
fixer  
establecer

**Kristeller**  
20-2660-00  
70x15 mm



Specula

Retractor

**Kristeller**  
(Standard)

Set of 1 specula and 1 retractor  
Set 1 Spekula und 1 Retraktor  
Set de 1 spéculum et 1 enrouleur  
1 Juego de especulos y retractor 1

Fig. 1 20-2661-00  
Fig. 2 20-2662-00  
Fig. 3 20-2663-00

**Specula**

	Fig.	a mm	b mm
20-2661-01	1	70	27
20-2662-01	2	80	30
20-2663-01	3	90	36

**Retractors**

	Fig.	a mm	b mm
20-2661-02	1	75	23
20-2662-02	2	85	26
20-2663-02	3	100	32



With conically shaped blades for virgins  
Mit konisch geformten Klängen für Jungfrauen  
Avec de forme conique lames pour vierges  
Con forma cónica cuchillas para vírgenes

**Kristeller**



With extra long blades  
Mit extra langen Klängen  
Avec de longues lames supplémentaires  
Con extra largas hojas

**Kristeller  
(Standard)**

Set of 1 specula and 1 retractor  
Set 1 Spekula und 1 Retraktor  
Set de 1 spéculums et 1 enrouleur  
1 Juego de espéculos y retractor 1

Fig. 00 20-2664-00  
Fig. 0 20-2665-00

**Specula**

	Fig.	a	b
		mm	mm
20-2664-01	00	110	18
20-2665-01	0	110	21

**Retractors**

	Fig.	a	b
		mm	mm
20-2664-02	00	115	14
20-2665-02	0	115	17

Set of 1 specula and 1 retractor  
Set 1 Spekula und 1 Retraktor  
Set de 1 spéculums et 1 enrouleur  
1 Juego de espéculos y retractor 1

Fig. 1 20-2666-00  
Fig. 2 20-2667-00  
Fig. 3 20-2668-00

**Specula**

	Fig.	a	b
		mm	mm
20-2666-01	1	110	27
20-2667-01	2	110	30
20-2668-01	3	110	36

**Retractors**

	Fig.	a	b
		mm	mm
20-2666-02	1	115	23
20-2667-02	2	115	26
20-2668-02	3	115	32

# Gynecology Instruments

Vaginal Speculas  
Vaginal Speculas

Speculas vaginales  
espéculos vaginales



With flat hollow specula  
Mit flachen Talkessel Spekula  
Avec spéculums à plat creux  
Con espéculos cuenca llana

Set of 1 specula and 1 retractor  
Set 1 Spekula und 1 Retraktor  
Set de 1 spéculums et 1 enrrouleur  
1 Juego de espéculos y retractor 1

Fig. 1 20-2669-00  
Fig. 2 20-2670-00  
Fig. 3 20-2671-00

### Specula

	Fig.	a	b
		mm	mm
20-2669-01	1	105	26
20-2670-01	2	105	28
20-2671-01	3	105	33

### Retractors

	Fig.	a	b
		mm	mm
20-2669-02	1	115	22
20-2670-02	2	115	24
20-2671-02	3	115	29

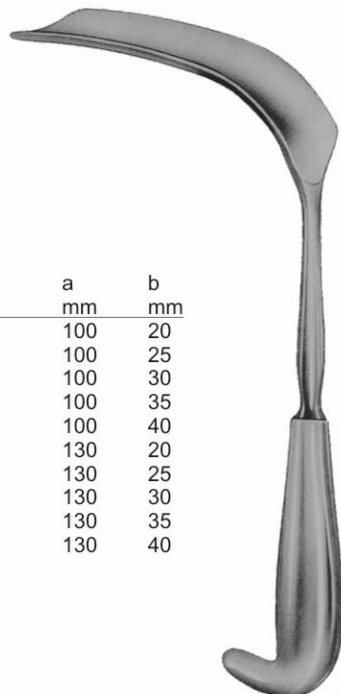

	a	b
	mm	mm
20-2672-20	100	20
20-2672-25	100	25
20-2672-30	100	30
20-2672-35	100	35
20-2672-40	100	40
20-2672-20	130	20
20-2672-25	130	25
20-2672-30	130	30
20-2672-35	130	35
20-2672-40	130	40

**Matzenauer**



**Braun**  
20-2673-18  
18 cm/7"  
56x13 mm

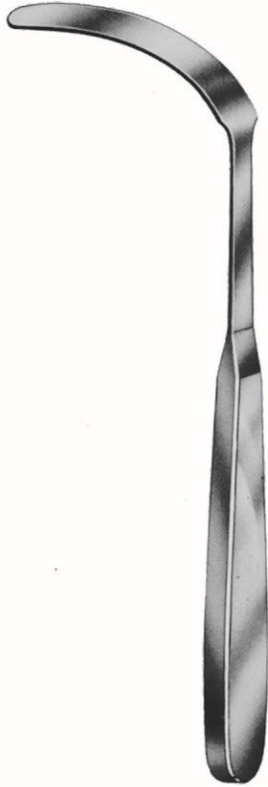

**Braun**  
20-2674-18  
18 cm/7"  
60x10 mm



**Ulrich**  
20-2675-19  
19.5 cm/7 1/2"  
80x20 mm



20-2676-19  
19 cm/7 1/2"  
85x17 mm

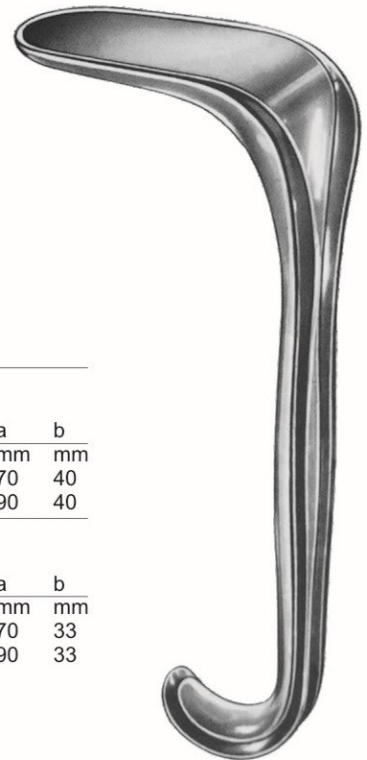

**Kallmorgen**

Set

20-2677-00	Fig. 1
20-2678-00	Fig. 2

Specula

Fig.	a		b	
	mm	mm	mm	mm
20-2677-01	1	70	40	
20-2678-01	2	90	40	

Retractors

Fig.	a		b	
	mm	mm	mm	mm
20-2677-02	1	70	33	
20-2678-02	2	90	33	

# Gynecology Instruments

Vaginal Speculas  
Vaginal Speculas

Speculas vaginales  
especulos vaginales

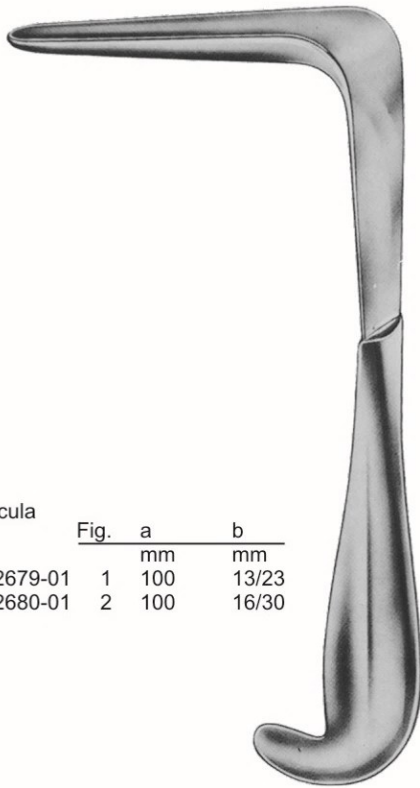

**Mathieu**

Specula	Fig.	a	b
		mm	mm
20-2679-01	1	100	13/23
20-2680-01	2	100	16/30

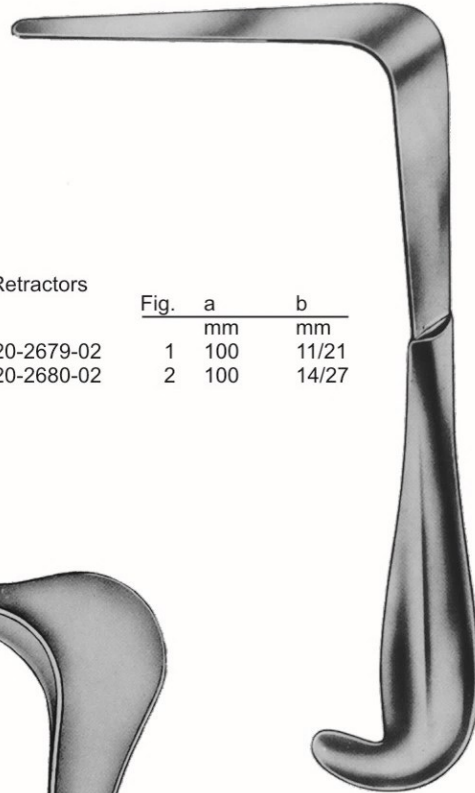

**Mathieu**

Retractors	Fig.	a	b
		mm	mm
20-2679-02	1	100	11/21
20-2680-02	2	100	14/27

Set	Fig.	mm	
		1	2
20-2681-01	1	11	21
20-2681-02	2	14	27

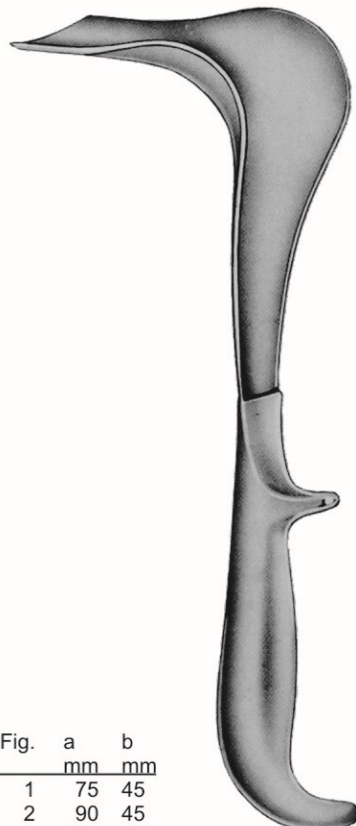

**Doyen**

Fig.	a	b
	mm	mm
20-2682-01	75	45
20-2682-02	90	45
20-2682-03	110	45



**Doyen**  
24 cm/9 1/2"  
slightly-concave  
leicht konkav-  
légèrement concave  
ligeramente cóncava

	Fig.	a mm	b mm	
20-2683-01	1	55	35	20-2686-01
20-2683-02	2	85	35	20-2686-02
20-2683-03	3	115	35	20-2686-03
20-2684-01	1	55	45	20-2687-01
20-2684-02	2	85	45	20-2687-02
20-2684-03	3	115	45	20-2687-03
20-2684-04	4	160	45	
20-2684-05	5	180	45	
20-2685-01	1	55	60	20-2688-01
20-2685-02	2	85	60	20-2688-02
20-2685-03	3	115	60	20-2688-03
20-2685-04	4	160	60	
20-2685-05	5	180	60	

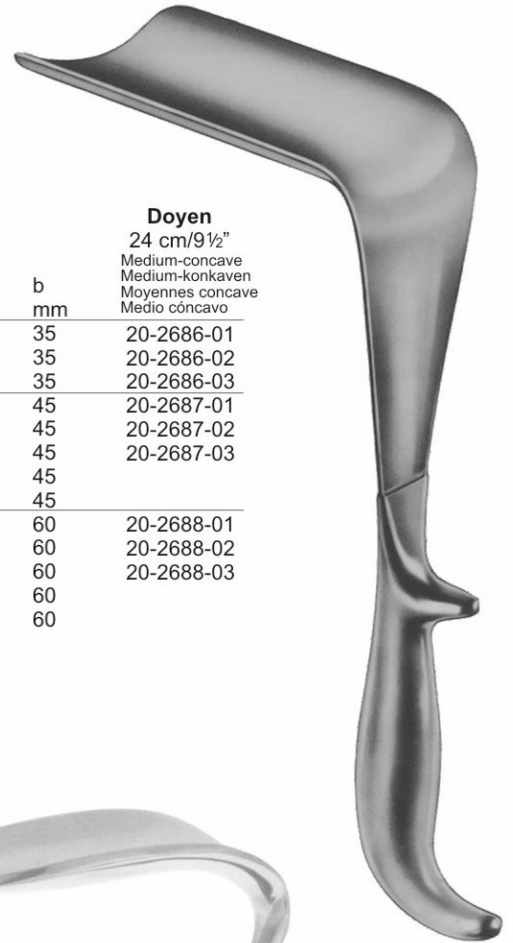

**Doyen**  
24 cm/9 1/2"  
Medium-concave  
Medium-konkaven  
Moyennes concave  
Medio cóncavo



**Doyen**  
25 cm/10"

	a mm	b mm
20-2689-01	60	30
20-2689-02	70	30
20-2689-03	80	30



**Mangiagalli**  
20-2690-00  
40 x 80 mm

# Gynecology Instruments

Vaginal Speculas  
Vaginal Speculas

Speculas vaginales  
especúlos vaginales



### Auvard

with removable weight  
mit abnehmbarem Gewicht  
avec un poids amovible  
con peso extraible

- 20-2691-01  
80x38mm
- 20-2691-02  
105x42mm

### Auvard

with fixed weight  
mit festem Gewicht  
avec un poids fixe  
con peso fijo

- 20-2692-01  
80x38 mm
- 20-2692-02  
105x42 mm

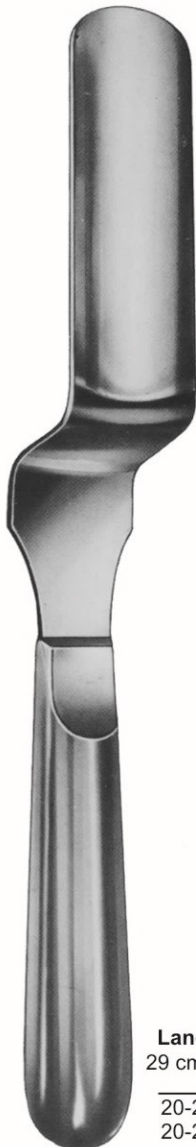

### Landau

29 cm/11½"

	a	b
	mm	mm
20-2693-01	100	28
20-2693-02	100	38



### Breisky

	a	b
	mm	mm
20-2694-20	100	20
20-2694-25	100	25
20-2694-30	100	30
20-2694-35	100	35
20-2694-40	100	40
20-2695-20	130	20
20-2695-25	130	25
20-2695-30	130	30
20-2695-35	130	35
20-2695-40	130	40
20-2696-20	160	20
20-2696-25	160	25
20-2696-30	160	30
20-2696-35	160	35
20-2696-40	160	40
20-2697-20	180	20
20-2697-25	180	25
20-2697-30	180	30
20-2697-35	180	35
20-2697-40	180	40

## Gynecology Instruments

Vaginal Speculas and Retractors  
Vaginal Speculas und Retraktoren

Speculas vaginaux et rétracteurs  
Espéculos vaginales y retractores



Bozemann  
20-2698-00

Complete



20-2698-05  
80 x 30 mm



20-2698-01  
65 x 30 mm



20-2698-06  
85 x 33 mm



20-2698-02  
75 x 35 mm

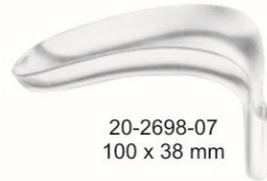

20-2698-07  
100 x 38 mm



20-2698-03  
85 x 35 mm



20-2698-08  
110 x 42 mm



20-2698-04  
95 x 35 mm

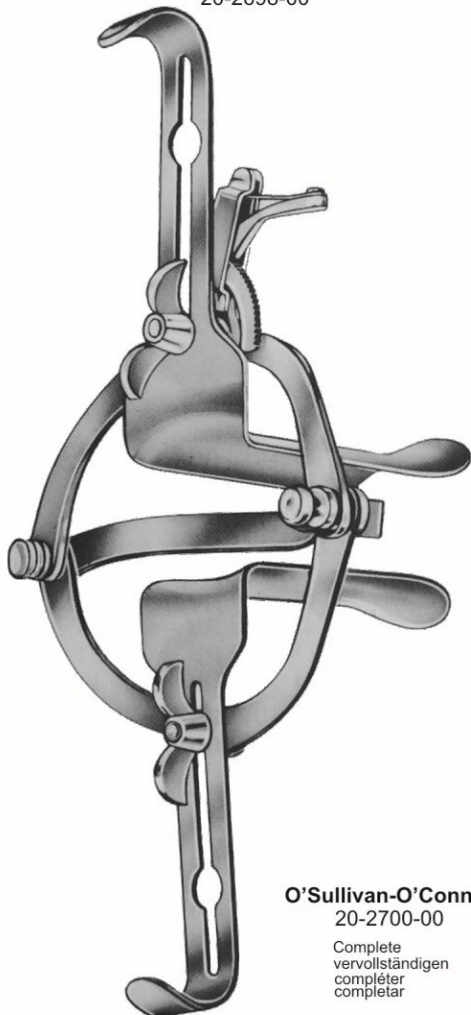

**O'Sullivan-O'Connor**  
20-2700-00

Complete  
vervollständigen  
compléter  
completar

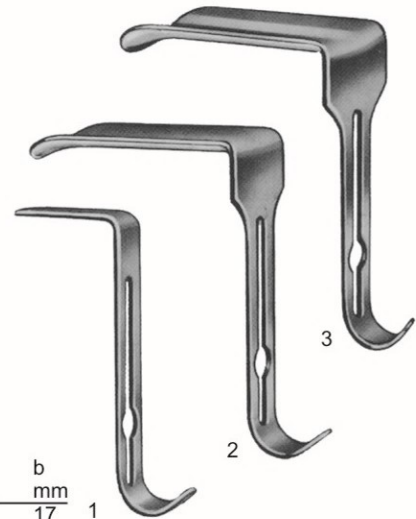

	Fig.	a mm	b mm
20-2699-01	1	45	17
20-2699-02	2	90	37
20-2699-03	3	90	45

# Gynecology Instruments

Uterine Dilators  
Uterus-Dilatatoren

Dilatateurs utérins  
dilatadores uterinos



Hegar

mm Ø		mm Ø	
1.0	20-2701-01	1.5	20-2702-01
2.0	20-2701-02	2.5	20-2702-02
3.0	20-2701-03	3.5	20-2702-03
4.0	20-2701-04	4.5	20-2702-04
5.0	20-2701-05	5.5	20-2702-05
6.0	20-2701-06	6.5	20-2702-06
7.0	20-2701-07	7.5	20-2702-07
8.0	20-2701-08	8.5	20-2702-08
9.0	20-2701-09	9.5	20-2702-09
10.0	20-2701-10	10.5	20-2702-10
11.0	20-2701-11	11.5	20-2702-11
12.0	20-2701-12	12.5	20-2702-12
13.0	20-2701-13	13.5	20-2702-13
14.0	20-2701-14	14.5	20-2702-14
15.0	20-2701-15	15.5	20-2702-15
16.0	20-2701-16	16.5	20-2702-16
17.0	20-2701-17	17.5	20-2702-17
18.0	20-2701-18	18.5	20-2702-18
19.0	20-2701-19	19.5	20-2702-19
20.0	20-2701-20		
21.0	20-2701-21		
22.0	20-2701-22		
23.0	20-2701-23		
24.0	20-2701-24		
25.0	20-2701-25		
26.0	20-2701-26		
27.0	20-2701-27		
28.0	20-2701-28		
29.0	20-2701-29		
30.0	20-2701-30		

Pieces per set		set	
20-2701-40	14	4.0-17.0 mm	In canvas
20-2701-50	14	4.0-17.0 mm	In metal case
20-2701-60	26	1.0-26.0 mm	in canvas
20-2701-70	26	1.0-26.0 mm	in metal case



Hegar

Ø mm	
1.0/2.0	20-2703-02
3.0/4.0	20-2703-04
5.0/6.0	20-2703-06
7.0/8.0	20-2703-08
9.0/10.0	20-2703-10
11.0/12.0	20-2703-12
13.0/14.0	20-2703-14
15.0/16.0	20-2703-16
17.0/18.0	20-2703-18
19.0/20.0	20-2703-20
21.0/22.0	20-2703-22
23.0/24.0	20-2703-24
25.0/26.0	20-2703-26

Pieces per set		set	
20-2703-40	08	3.0/4.0-17.0/18.0 mm	
20-2704-60	13	1.0/2.0-25.0/26.0 mm	
20-2703-50	08	3.0/4.0-17.0/18.0 mm	
20-2704-70	13	1.0/2.0-25.0/26.0 mm	

## Gynecology Instruments

Uterine Dilators  
Uterus-Dilatatoren

Dilatateurs utérins  
dilatadores uterinos



**Pratt**

Fig.	mm	
13/15	4.5/5.0	20-2705-15
17/19	5.6/6.3	20-2705-19
21/23	7.0/7.6	20-2705-23
25/27	8.3/9.0	20-2705-27
29/31	9.6/10.3	20-2705-31
33/35	11.0/11.6	20-2705-35
37/39	12.3/13.0	20-2705-39
41/43	13.6/14.3	20-2705-43

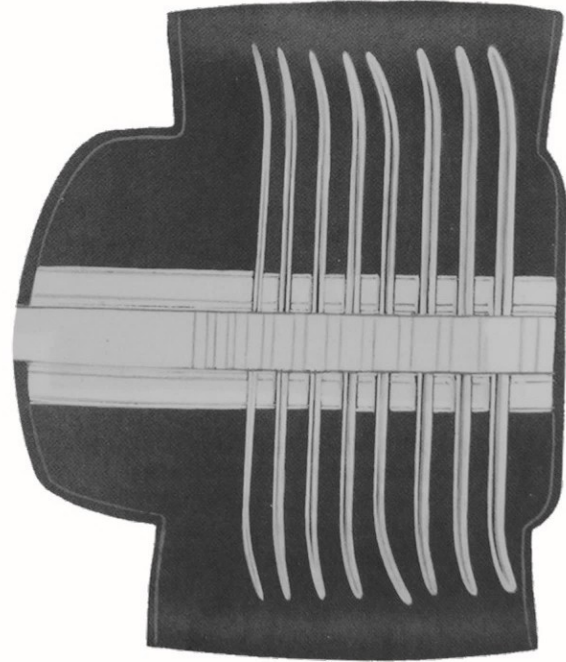

Set  
20-2705-00

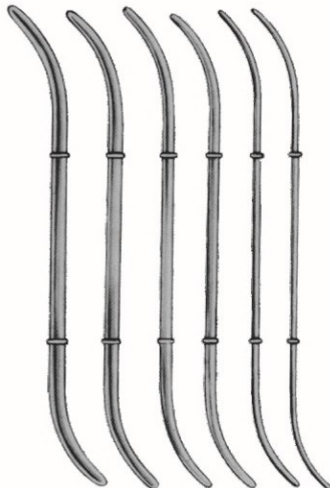

**Hank**  
20-2706-00

Fig.	mm	
9/10	4.5/5	20-2706-10
11/12	5.5/6	20-2706-12
13/14	6.5/7	20-2706-14
15/16	7.5/8	20-2706-16
17/18	8.5/9	20-2706-18
19/20	9.5/10	20-2706-20

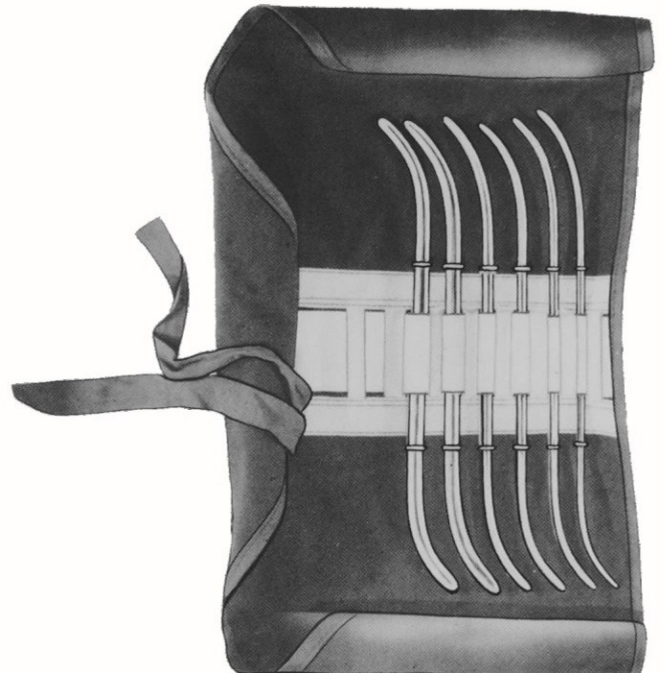

Set

# Gynecology Instruments

Uterine Tenaculum Forceps, Amniotome  
Uterine Håkchen Pinzette, Amniotome

Tenaculum utérine Forceps, amniotomie  
Uterina tenáculo pinzas, Amniotome



**Sims**  
20-2707-33  
33 cm/13"



**Sims**  
20-2708-33  
33 cm/13"



**Walleix**  
20-2709-29  
29.5 cm/11 1/2"



**Braun**  
20-2710-27  
27.5 cm/11 3/4"

## Gynecology Instruments

Uterine Sounds, Uterine Depressor  
Uterus-Sounds, Uterus-Depressor

Sons utérins, de l'utérus dépresseurs  
Los sonidos uterinos, útero depresores



**Schröder**  
20-2711-25  
25.5 cm/10 "



**Duply**  
20-2712-25  
25.5 cm/10 "

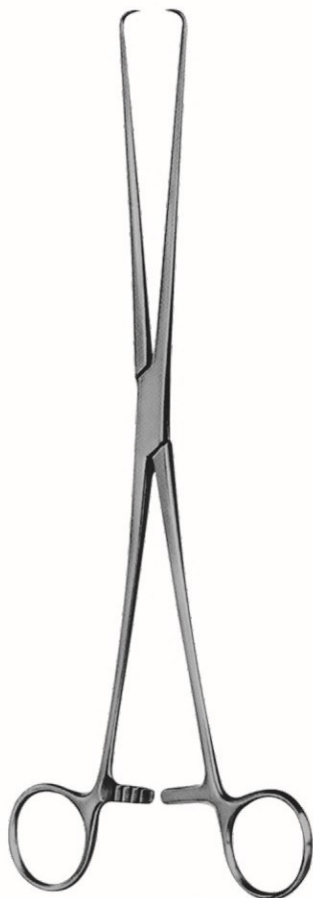

<sup>1</sup>/<sub>4</sub>  
**Braun**  
20-2713-25  
25 cm/10 "



**Beacham**  
20-2714-26  
26 cm/10 <sup>1</sup>/<sub>4</sub>"

# Gynecology Instruments

Uterine Tenaculum Forceps  
Uterine Tenakulum Zange

Utérine Forceps tenaculum  
Pinza uterina tenáculo

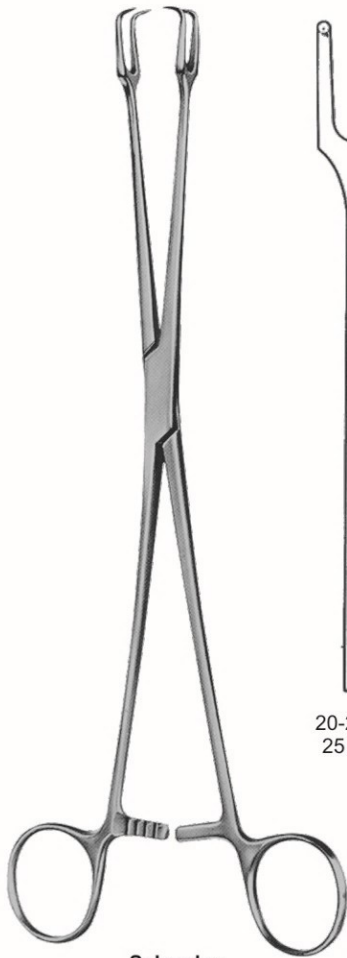

**Schroder**

20-2715-25  
25 cm/9 <sup>3</sup>/<sub>4</sub>"

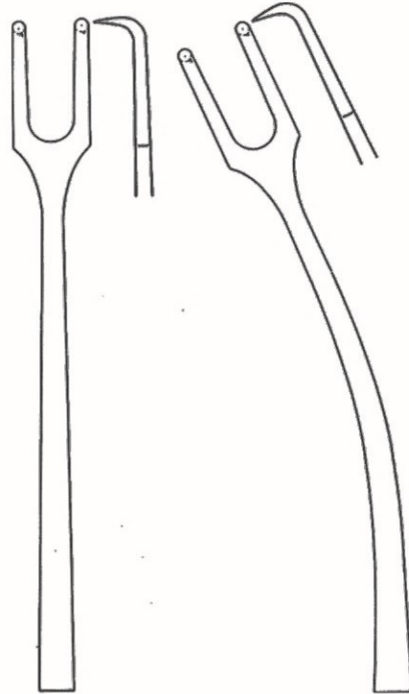

20-2716-23  
23.5 cm/9 <sup>1</sup>/<sub>4</sub>"



**Skene**  
20-2717-24  
24 cm/9 <sup>1</sup>/<sub>2</sub>"



**Teale**  
20-2718-23  
23.5 cm/9 <sup>1</sup>/<sub>4</sub>"

## Gynecology Instruments

Uterine Tenaculum Forceps  
Uterine Tenakulum Zange

Utérine Forceps tenaculum  
Pinza uterina tenáculo



Iowa



20-2719-26  
26 cm/10 1/4"

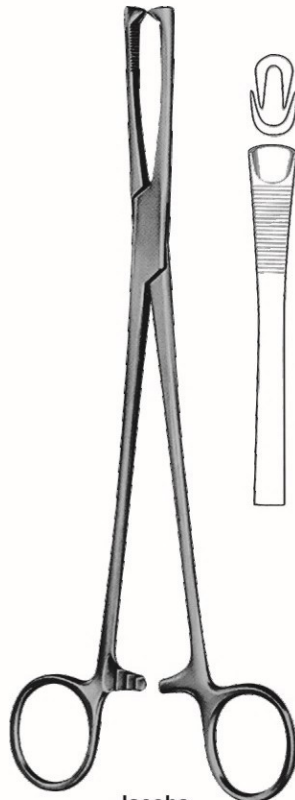

Jacobs



20-2723-21  
21 cm/8 1/4"



Museux



6 mm  
20-2720-24  
24 cm/9 1/2"



6 mm  
20-2721-24  
24 cm/9 1/2"



6 mm  
20-2722-24  
24 cm/9 1/2"

# Gynecology Instruments

Uterine Tenaculum Forceps  
Uterine Tenakulum Zange

Utérine Forceps tenaculum  
Pinza uterina tenáculo

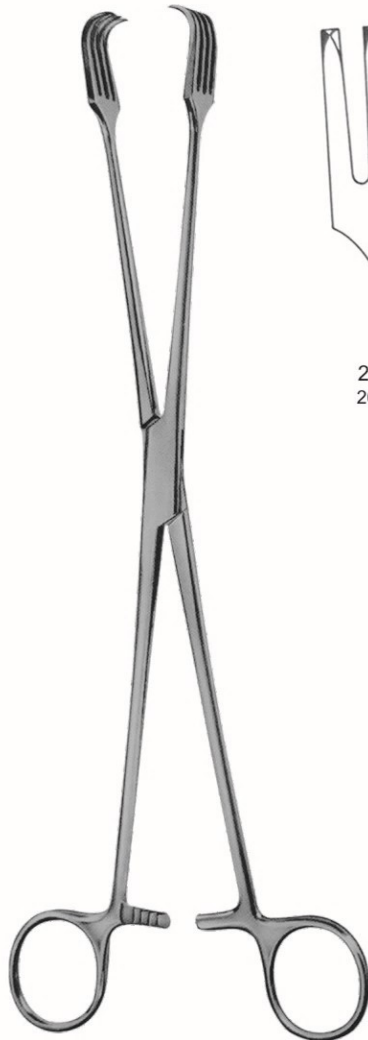

20-2724-26  
26.5 cm/10 1/2"

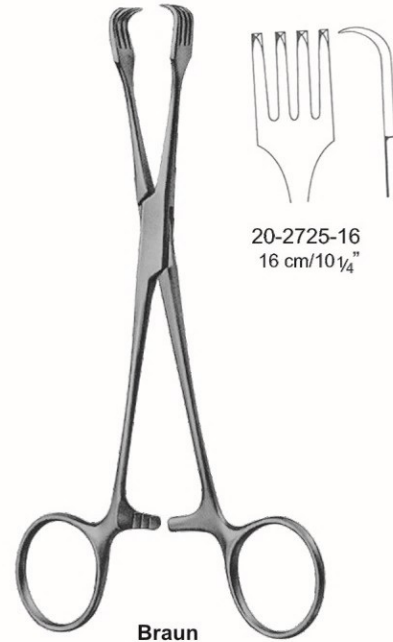
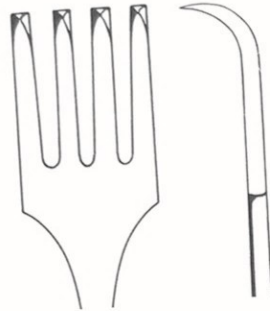

20-2725-16  
16 cm/10 1/4"

Braun

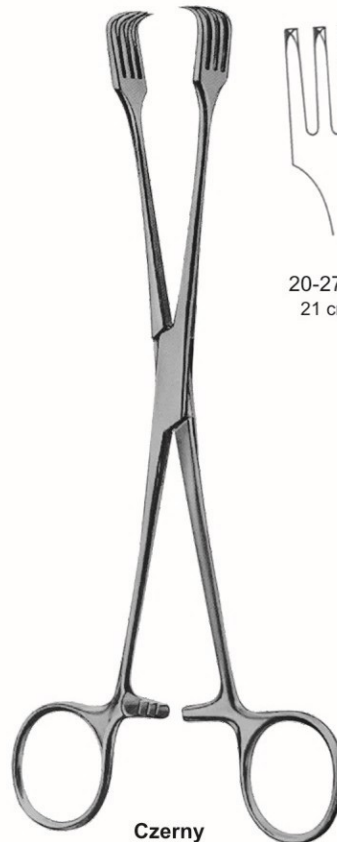
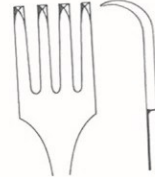

20-2726-21  
21 cm/8 1/4"

Czerny



## Gynecology Instruments

Uterine Pulypus Forceps  
Uterine Pulypus Zange

Utérine Pulypus Forceps  
Pinza uterina Pulypus



20-2727-32  
32 cm/12½"



20-2728-27  
27 cm/10¼"

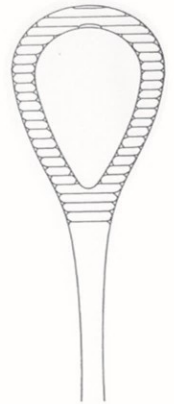

20-2729-25  
25 cm/9¾"

## Gynecology Instruments

Uterine Seizing Forceps  
Uterine ergriff Zange

Utérins Forceps Saisir  
Uterinos Pinzas Aprovechar



**Dartigues**  
20-2733-25  
28 cm/11"

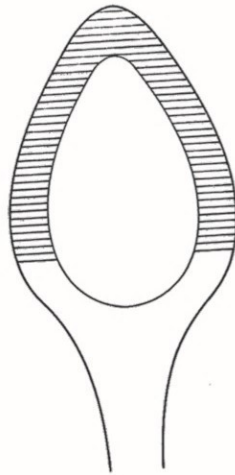
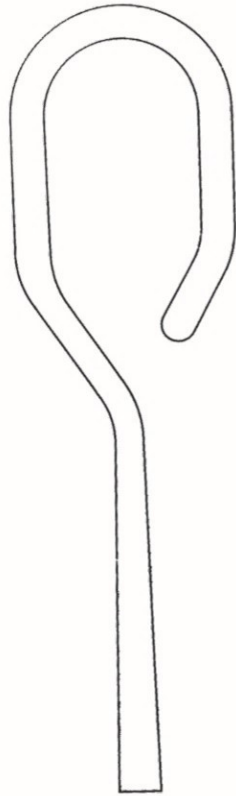

**Somer**  
20-2734-25  
22.5 cm/8 3/4"

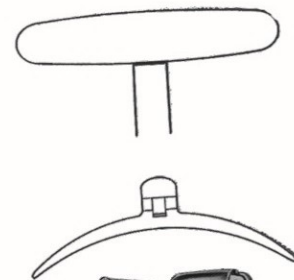

**Collin**  
20-2735-26  
26 cm/10 1/4"

# Gynecology Instruments

Myoma Screws, Myoma Knife  
Schrauben Myom, Myome Knife

Vis myome, couteaux myomes  
Tornillos, mioma Mioma Knife



**Doyen**  
20-2730-17  
17 cm/6 3/4"



**Doyen**  
20-2731-14  
14.5 cm/5 3/4"



20-2732-28  
28 cm/11"

**Segand**

3/4

## Gynecology Instruments

Suction Curettes, Uterine Biopsy Curettes  
Saug-Küretten, Uterus-Biopsie Küretten

Curettes d'aspiration, de l'utérus biopsie Curettes  
Curetas de aspiración, biopsia uterina Curetas



**Novak**

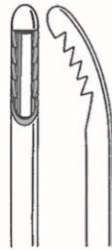

20-2740-24  
25.5cm/8 3/4"  
4.0 mm Ø



**Novorkian**



20-2741-30  
30cm/11 3/4"  
6.0 mm Ø



**Munchen**

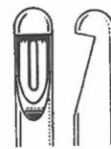

20-2742-27  
27 cm/10 3/4"  
4.8 mm Ø

# Gynecology Instruments

Fistula Hooks  
Fistula Haken

Crochets fistule  
Ganchos fístula

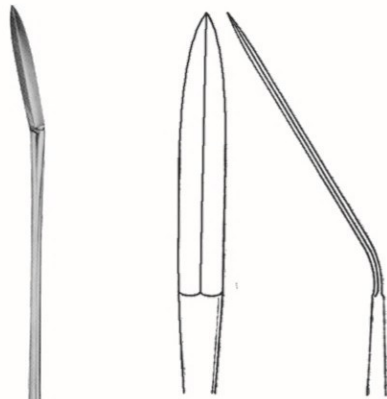

20-2736-23  
23.5 cm/9 1/4"

**Ayre**



20-2737-23  
22 cm/9 3/4"

**Emmett**



20-2738-21  
21.5cm/8 1/2"

**Simon**



20-2739-21  
21.5cm/8 1/2"

**Simon**

# Gynecology Instruments

Uterine Biopsy Forceps  
Uterine Biopsiezangen

Pince à biopsie utérine  
Pinzas de biopsia uterina

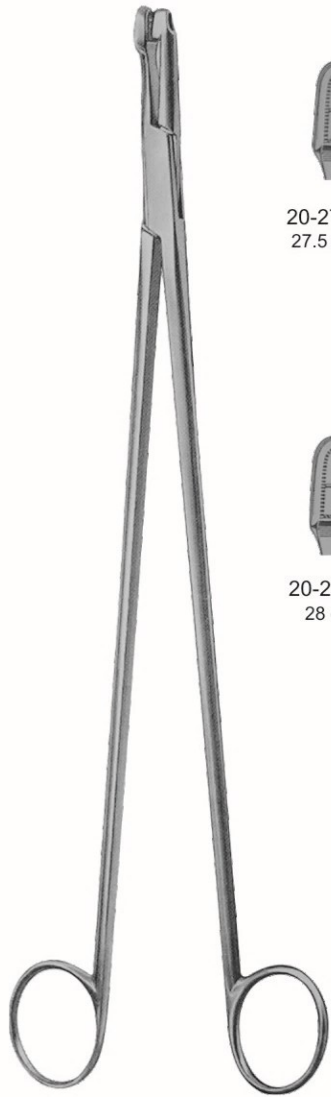

**Schubert**

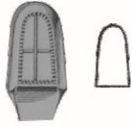

20-2743-21  
27.5 cm/8 1/2"

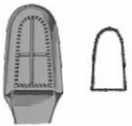

20-2743-28  
28 cm/11"



**Faure**



20-2744-21  
21 cm/8 1/4"



20-2745-24  
24 cm/8 1/2"



**Gellhorn**

## Gynecology Instruments

Uterine Biopsy Forceps  
Uterine Biopsiezangen

Pince à biopsie utérine  
Pinzas de biopsia uterina



20-2746-21  
21 cm/8 $\frac{1}{4}$ "



20-2746-23  
23.5 cm/9 $\frac{1}{4}$ "



**Thoms-Gaylor**

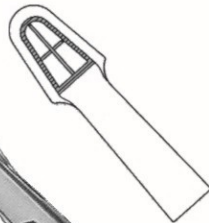

20-2747-25  
25.5 cm/10"



**Schubert**



20-2748-27  
27cm/10 $\frac{3}{4}$ "

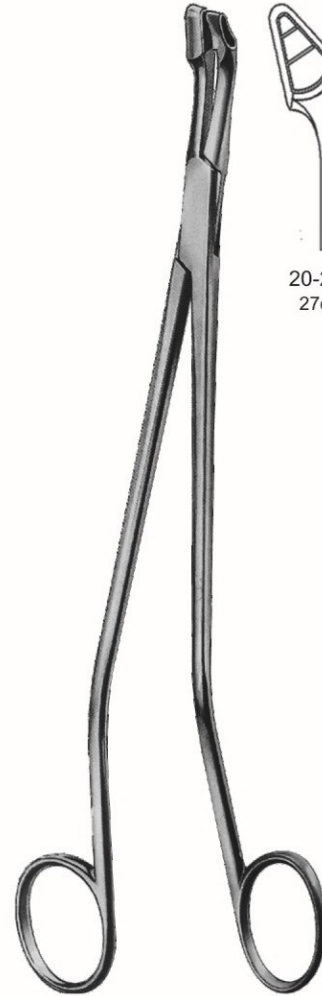

**Van Doren**

# Gynecology Instruments

Uterine Biopsy Forceps  
Uterine Biopsiezangen

Pince à biopsie utérine  
Pinzas de biopsia uterina

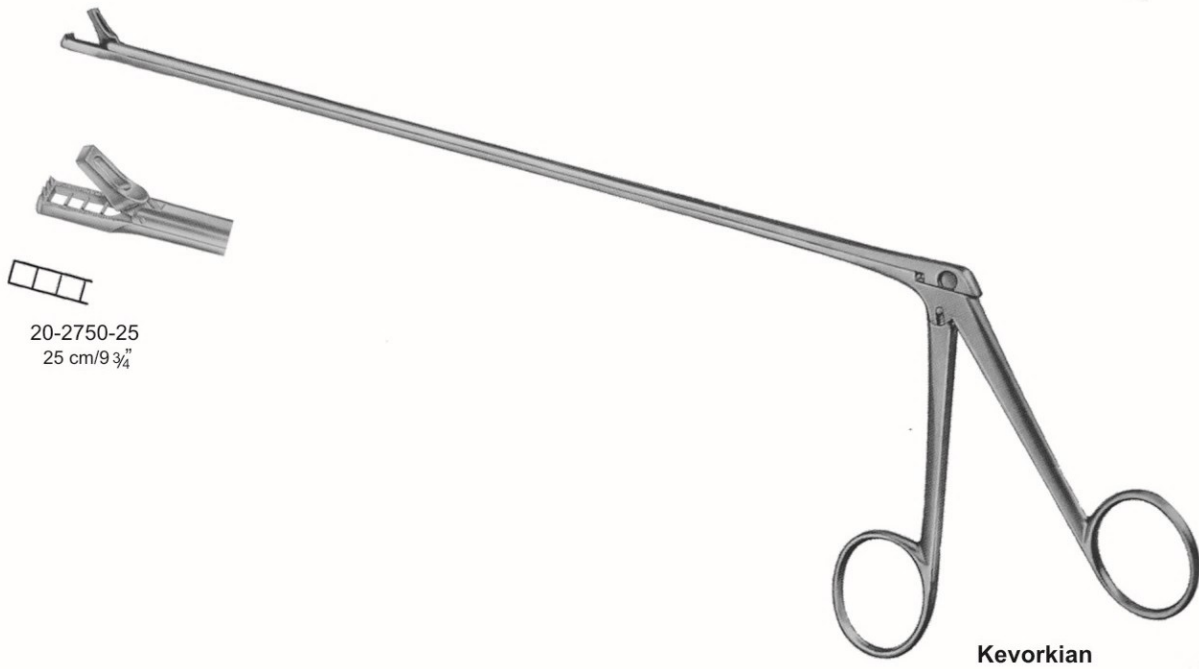
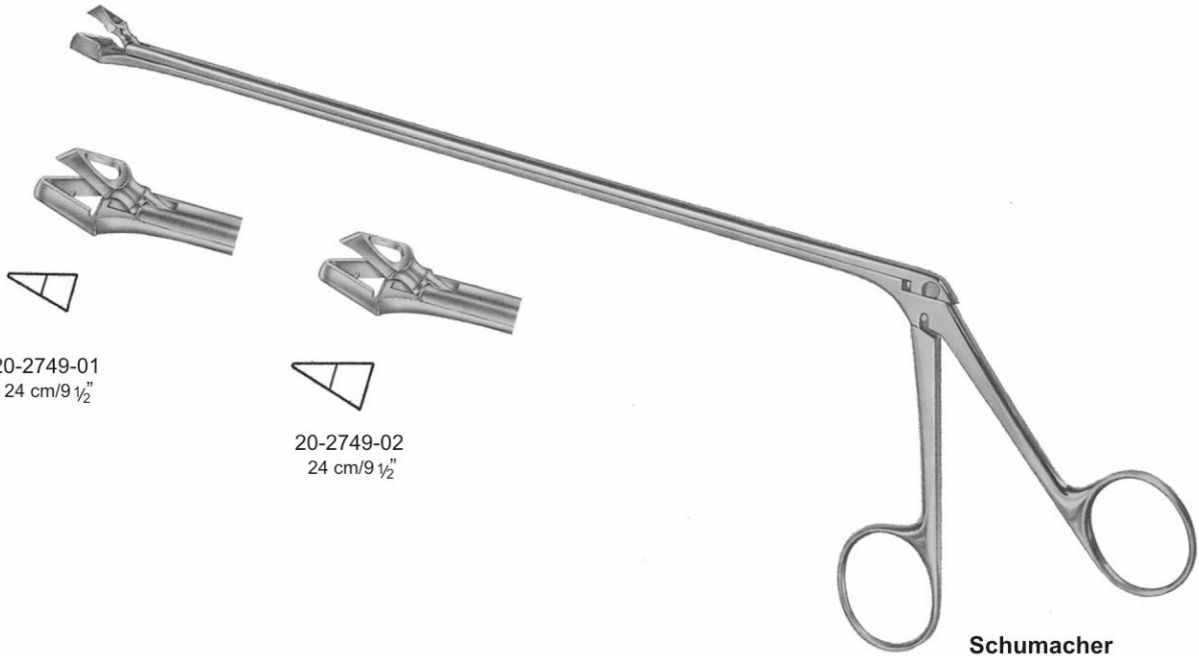

## Gynecology Instruments

Uterine Biopsy Forceps  
Uterine Biopsiezangen

Pince à biopsie utérine  
Pinzas de biopsia uterina



20-2751-25  
25.5 cm/10"

**Van Doren**



20-2752-28  
28 cm/11"

**Alexander**

# Gynecology Instruments

Uterine Biopsy Forceps, IUP Grasping Forceps  
Uterine Biopsiezangen, IUP Faßzange

Utérine pincés à biopsie, pincés à préhension IUP  
Uterina pinzas de biopsia, Pinzas IUP Agarre

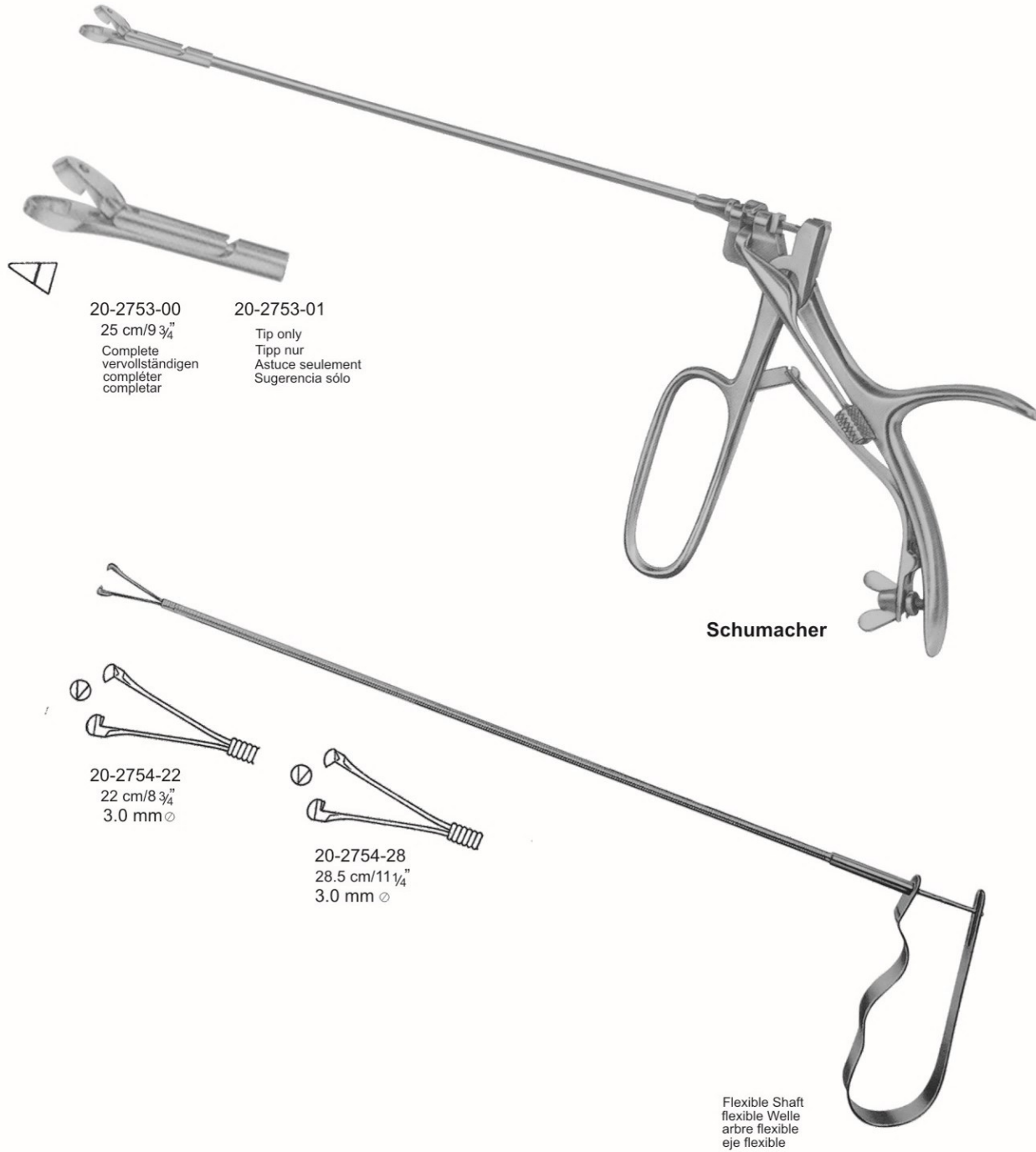

20-2753-00  
25 cm/9 3/4"  
Complete  
vervollständigen  
compléter  
completar

20-2753-01  
Tip only  
Tipp nur  
Astuce seulement  
Sugerencia sólo

**Schumacher**

20-2754-22  
22 cm/8 3/4"  
3.0 mm  $\varnothing$

20-2754-28  
28.5 cm/11 1/4"  
3.0 mm  $\varnothing$

Flexible Shaft  
flexible Welle  
arbre flexible  
eje flexible

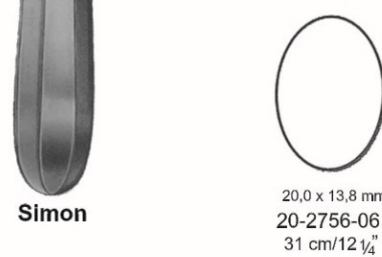
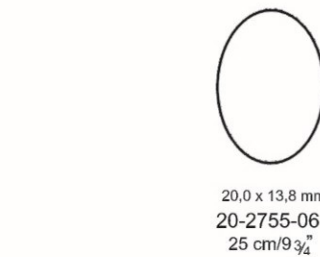
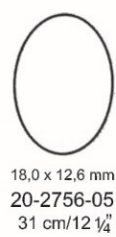
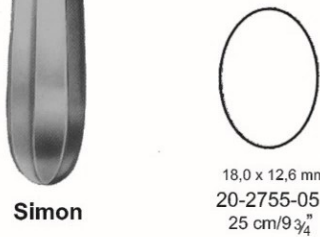
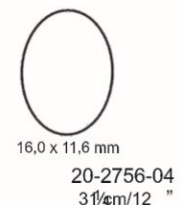
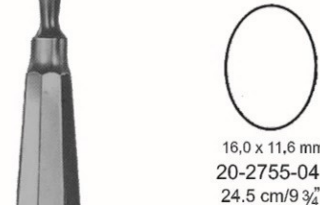
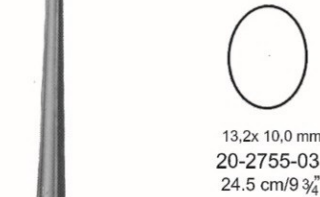
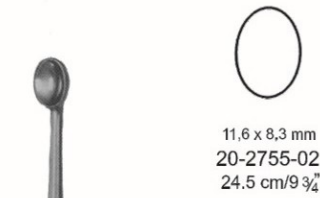

# Gynecology Instruments

Uterine Curettes      Curettes utérines  
 Uterus-Küretten      Curetas uterinas



**Recamier**  
 20-2757-05  
 20-2757-40



**Recamier**  
 20-2758-05  
 20-2758-40



**Sims**  
 20-2759-05  
 20-2759-40



**Sims**  
 20-2760-05  
 20-2760-40

Fig	mm	20-2757-05	20-2758-05	20-2759-05	20-2760-05
00	5	20-2757-05	20-2758-05	20-2759-05	20-2760-05
0	6	20-2757-06	20-2758-06	20-2759-06	20-2760-06
1	7	20-2757-07	20-2758-07	20-2759-07	20-2760-07
2	8	20-2757-08	20-2758-08	20-2759-08	20-2760-08
3	9	20-2757-09	20-2758-09	20-2759-09	20-2760-09
4	10	20-2757-10	20-2758-10	20-2759-10	20-2760-10
5	12	20-2757-12	20-2758-12	20-2759-12	20-2760-12
6	14	20-2757-14	20-2758-14	20-2759-14	20-2760-14
7	15	20-2757-15	20-2758-15	20-2759-15	20-2760-15
8	16	20-2757-16	20-2758-16	20-2759-16	20-2760-16
9	19	20-2757-19	20-2758-19	20-2759-19	20-2760-19
10	20	20-2757-20	20-2758-20	20-2759-20	20-2760-20
11	21	20-2757-21	20-2758-21	20-2759-21	20-2760-21
12	23	20-2757-23	20-2758-23	20-2759-23	20-2760-23
13	25	20-2757-25	20-2758-25	20-2759-25	20-2760-25
14	30	20-2757-30	20-2758-30	20-2759-30	20-2760-30
15	35	20-2757-35	20-2758-35	20-2759-35	20-2760-35
16	40	20-2757-40	20-2758-40	20-2759-40	20-2760-40



Fig. 00  
5 mm  
31 cm/12 1/4"  
20-2761-05



Fig. 0  
6 mm  
31 cm/12 1/4"  
20-2761-06



Fig. 1  
7 mm  
31 cm/12 1/4"  
20-2761-07



Fig. 2  
8 mm  
31 cm/12 1/4"  
20-2761-08



Fig. 3  
9 mm  
31 cm/12 1/4"  
20-2761-09



Fig. 4  
11 mm  
31 cm/12 1/4"  
20-2761-11



Fig. 5  
12 mm  
31 cm/12 1/4"  
20-2761-12



Fig. 6  
14 mm  
31 cm/12 1/4"  
20-2761-14



Fig. 7  
15 mm  
31 cm/12 1/4"  
20-2761-15



Fig. 8  
16 mm  
31 cm/12 1/4"  
20-2761-16



Fig. 9  
19 mm  
31 cm/12 1/4"  
20-2761-19



Fig. 10  
20 mm  
31 cm/12 1/4"  
20-2761-20



Fig. 11  
21 mm  
31 cm/12 1/4"  
20-2761-21



Fig. 12  
23 mm  
31 cm/12 1/4"  
20-2761-23



Fig. 13  
25 mm  
34 cm/13 1/2"  
20-2761-25



Fig. 14  
30 mm  
35 cm/12 3/4"  
20-2761-30



Fig. 15  
35 mm  
35 cm/12 3/4"  
20-2761-35



Fig. 16  
40 mm  
35 cm/12 3/4"  
20-2761-40