

Oral Maxillo Facial Surgery

Tongue Spatulas
Zungenspatel

Spatules Tongue
Espátulas Lengua

Accu-Med[®]
Instrument Co.



Doyen

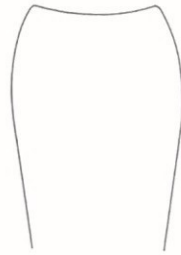

25-3518-13
13.5 cm / 5 1/4"
24 / 30 mm

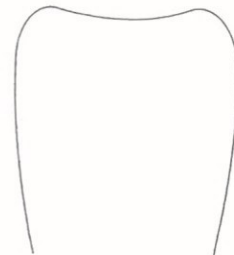

25-3518-16
16 cm / 6 1/4"
30 / 34 mm

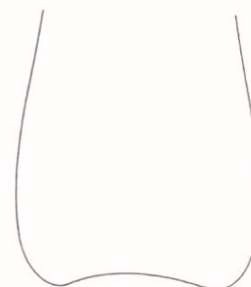
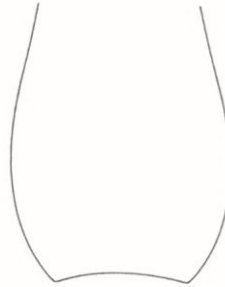

25-3519-16
15 cm / 6"

Package of 100
pieces plastic
Paket von 100
Stück Kunststoff
Paquet de 100
plastique morceaux
Paquete de 100
piezas de plástico



25-3520-16
16 cm / 6 1/4"

Package of 100
pieces wood
Paket von 100
Stück Holz
Paquet de 100
des morceaux de bois
Paquete de 100
piezas de madera



25-3521-19
19 cm / 7 1/2"
19 / 15 mm

Brunings

Oral Maxillo Facial Surgery

Elevators, Graft Packers
Aufzüge, Graft Packers

Ascenseurs, Packers greffon
Ascensores, Packers injerto



Terry

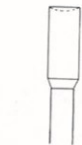

25-3483-11
11 cm / 4 3/8"



Terry
17 cm / 6 3/4"



25-3484-17
6.0 / 8.0 mm



25-3485-13
13 cm / 6"



Terry
18 cm / 7"



25-3486-18
3.5 / 7.0 mm



Oral Maxillo Facial Surgery

Sinus Lift Currettes
Sinus Lift Küretten

Currettes Sinus Lift
Sinus Lift Curetts



25-3487-01
18 cm / 7"
2.6 / 2.6 mm



25-3487-02
17.5 cm / 7"
2.5 / 2.5 mm



25-3487-03
17.5 cm / 7"
2.5 / 2.5 mm



25-3487-04
18.5 cm / 7 1/2"
2.5 / 2.5 mm



25-3487-05
19 cm / 7 1/2"
2.5 / 2.5 mm



25-3487-06
18.5 cm / 7 1/4"
6.7 / 6.7 mm



25-3487-07
16 cm / 6 1/4"
2.8 / 6.2 mm



25-3487-08
16 cm / 6 1/4"
2.8 / 6.2 mm



25-3487-09
15 cm / 6"
3.1 / 3.1 mm



25-3487-10
17 cm / 6 3/4"
5.5 / 5.5 mm

Oral Maxillo Facial Surgery

Sinus Lift Currettes
Sinus Lift Küretten

Currettes Sinus Lift
Sinus Lift Curetas

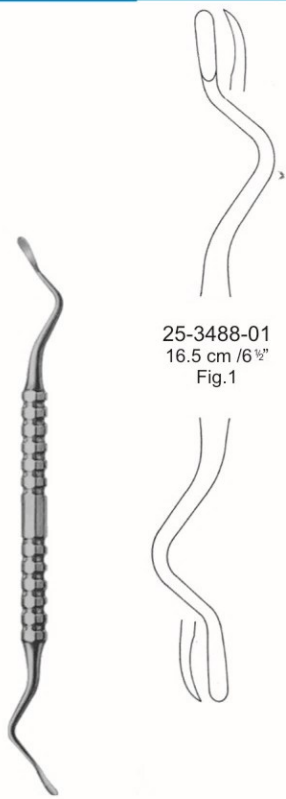

25-3488-01
16.5 cm / 6 1/2"
Fig.1

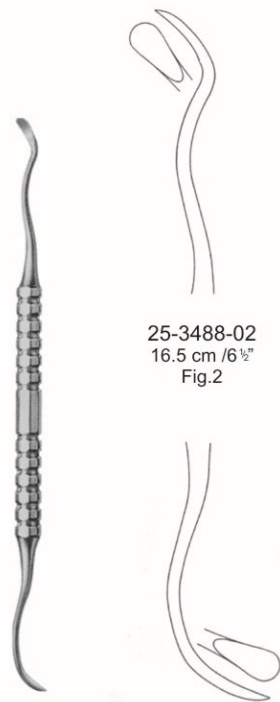

25-3488-02
16.5 cm / 6 1/2"
Fig.2

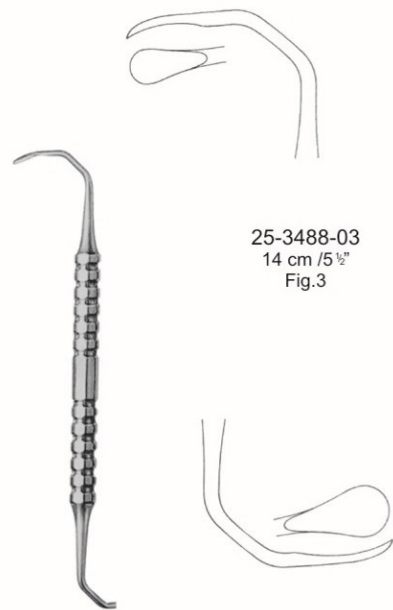

25-3488-03
14 cm / 5 1/2"
Fig.3

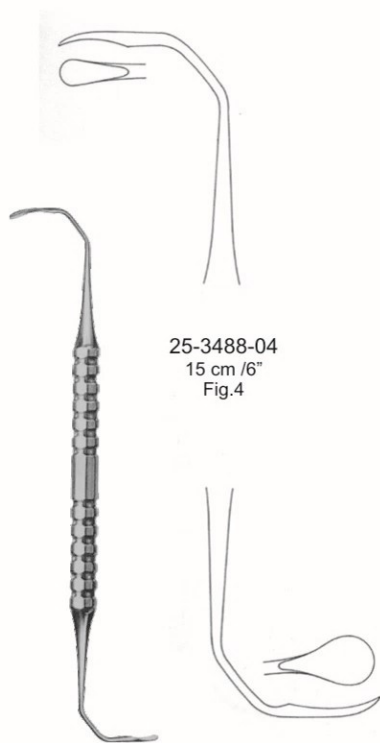

25-3488-04
15 cm / 6"
Fig.4



25-3488-05
15 cm / 6"
Fig.5



25-3489-45
4.5 cm / 1 3/4"
10 mm



25-3489-65
6.5 cm / 2 1/2"
22 mm



25-3489-80
8 cm / 3 1/4"
35 mm



Adams
25-3490-01

Napkin Holder Consisting of chain and two crocodile forceps
Napkin Holder Bestehend aus Kette und zwei Krokodil Pinzette
Napkin Holder Composée de chaîne et deux pinces crocodile
Servilletero Consistente en cadena y dos pinzas de cocodrilo



Langenbeck
25-3491-02
21 mm ø



Maunder
25-3492-10
wood
Holz
bois
madera



Pitha
25-3493-02
Silicone
Silikon
silicone
silicona

Oral Maxillo Facial Surgery

Mouth Gags
Mund Gags

Gags bouche
Mordaza De la Boca



Heister
25-3494-13
13 cm / 5"



Obwegeser
25-3495-11
11 cm / 4 1/4"



Molt
25-3496-11
11 cm / 4 1/4"



Molt
25-3497-11
13 cm / 5"



Denhart
25-3498-11
13 cm / 5"



Roser-Konig

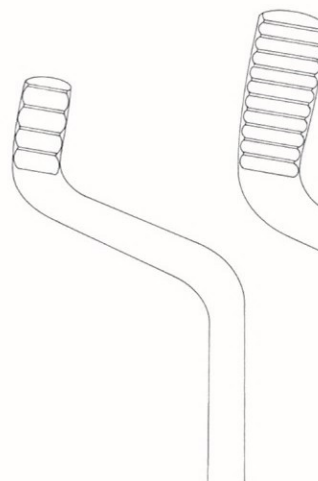

25-3499-16
16 cm / 6 1/4"

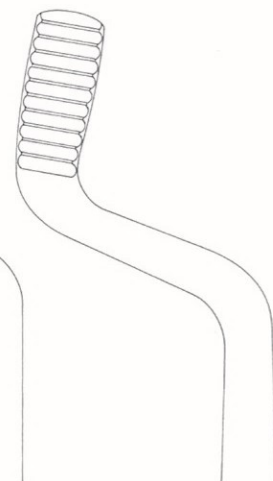

25-3499-20
20 cm / 8"



Kilner-Doughty
25-3500-00
Chest Support



Kilner-Doughty
25-3501-00

complete with frame, 3 tongue depressors
2 tooth plate and 1 palate plate
komplett mit Rahmen, 3 Zungenspatel
2 Zahnplatte und 1 Gaumenplatte
compléter avec cadre, 3 abaisse-langue
2 plaque dentaire et 1 plaque palatine
completar con marco, 3 depresores de lengua
2 diente placa y 1 placa paladar



25-3501-01
13.5 cm / 5 1/4"
70 x 29 mm



25-3501-02
13.5 cm / 5 1/4"
80 x 34 mm



25-3501-03
13.5 cm / 5 1/4"
85 x 38 mm

Oral Maxillo Facial Surgery

Mouth Gags
Mund Gags

Gags bouche
Mordaza De la Boca



Davis-Boyle
25-3502-00

complete consisting of frame and five tongue depressors no. 1 to 5
komplett bestehend aus Rahmen und fünf Zungenspatel keine, 1 bis 5
compléter consistant en un cadre et cinq abaisse-langue non, de 1 à 5
completar consistente en un marco y cinco depresores de lengua no, desde 1 hasta 5



Davis-Boyle
25-3502-01

13.5 cm / 5 1/4"
110 x 26 mm
Tongue depressor
Zungenspatel
abaisse-langue
depresor de lengua



25-3502-02
13.5 cm / 5 1/4"
95 x 25 mm



25-3502-03
13.5 cm / 5 1/4"
80 x 24 mm



25-3502-04
13.5 cm / 5 1/4"
65 x 23 mm



25-3502-05
13.5 cm / 5 1/4"
30 x 20 mm

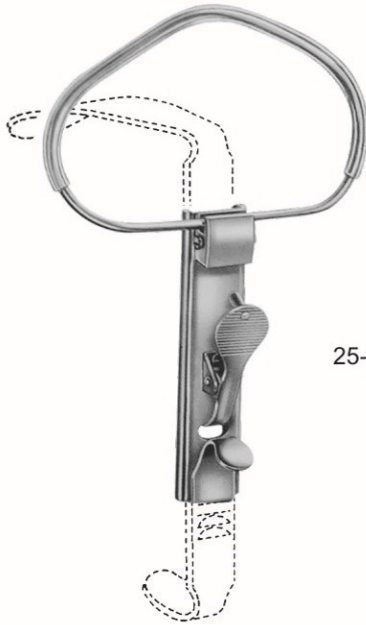

25-3503-00

Mclvor

25-3503-10
15 cm / 6"
Frame for Mouth Gag
65 x 100 mm

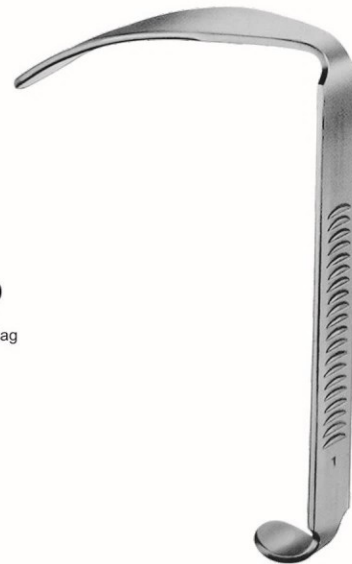

25-3503-01
13.5 cm / 5 1/4"
100 x 26 mm

Mclvor
Tongue Depressor

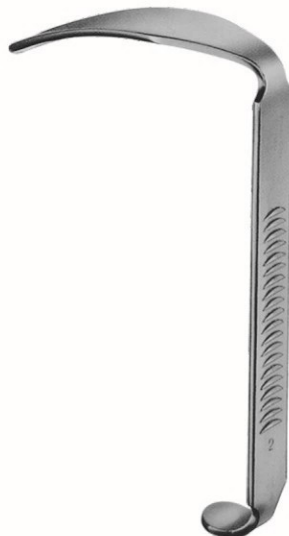

25-3503-02
13.5 cm / 5 1/4"
85 x 25 mm

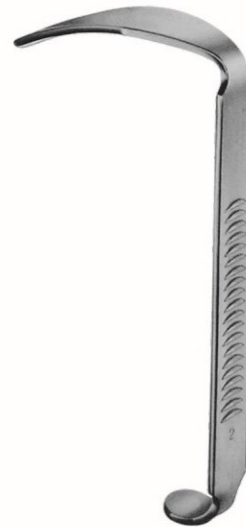

25-3503-03
13.5 cm / 5 1/4"
75 x 23 mm

Oral Maxillo Facial Surgery

Mouth Gags
Mund Gags

Gags bouche
Mordaza De la Boca

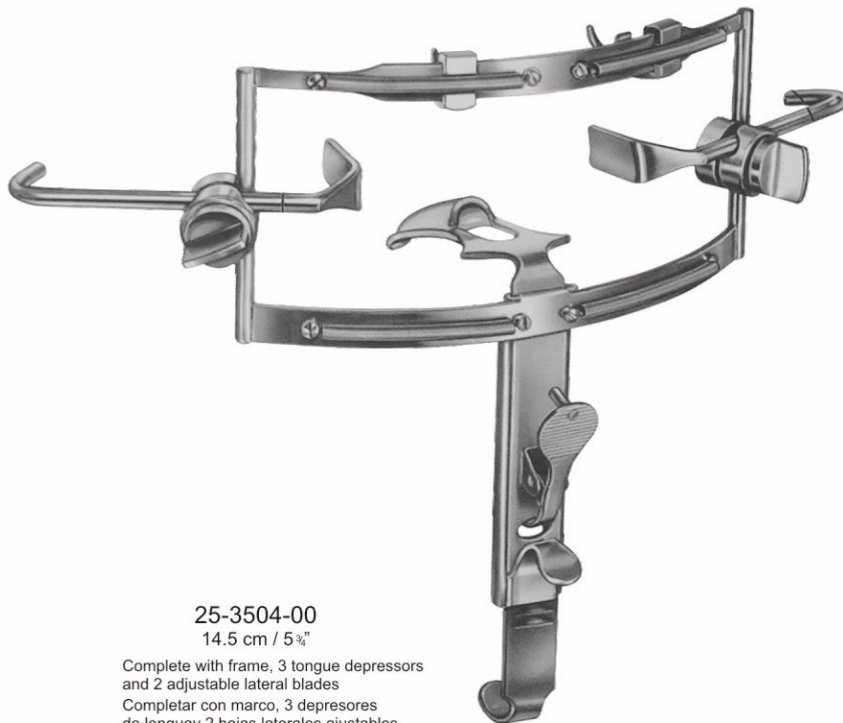

25-3504-00
14.5 cm / 5 7/8"

Complete with frame, 3 tongue depressors
and 2 adjustable lateral blades
Completar con marco, 3 depresores
de lenguay 2 hojas laterales ajustables
Compléter avec cadre, 3 abaisse-langue
et 2 réglables lames latérales
Completar con marco, 3 depresores
de lengua y 2 hojas laterales ajustables

Dingmann

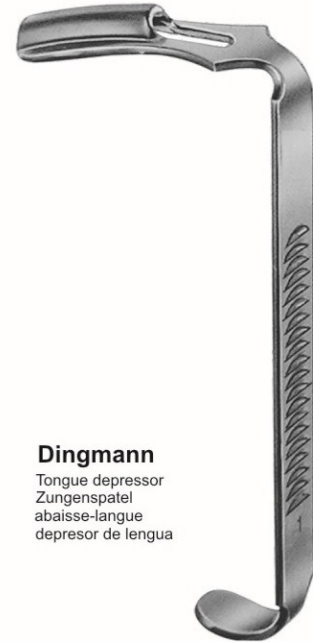

Dingmann

Tongue depressor
Zungenspatel
abaisse-langue
depressor de lengua

25-3504-01
13.5 cm / 5 1/4"
65 x 25 mm

Dingmann
Tongue depressor
Zungenspatel
abaisse-langue
depressor de lengua



25-3504-02
13.5 cm / 5 1/4"
70 x 29 mm

25-3504-03
13.5 cm / 5 1/4"
80 x 32 mm



Jenninge

25-3505-09 10.5 cm / 4"
25-3505-11 12.5 cm / 5"
25-3505-13 10.5 cm / 5 3/8"
25-3505-15 10.5 cm / 6 1/2"



25-3506-00 9.5 cm / 3 3/4" 95 mm

25-3506-01 10 cm / 4" 110 mm

25-3506-02 10.5 cm / 4" 115 mm

25-3506-03 11 cm / 4 1/4" 120 mm

25-3506-13

Jenninge

self-retaining
selbsthaltende
autostatische
auto-retención

For Children
für Kinder
pour les enfants
Para los niños

set with no. 1-3
establecido con el n. 1-3
mis à aucune. 1-3
establecido con el n. 1-3

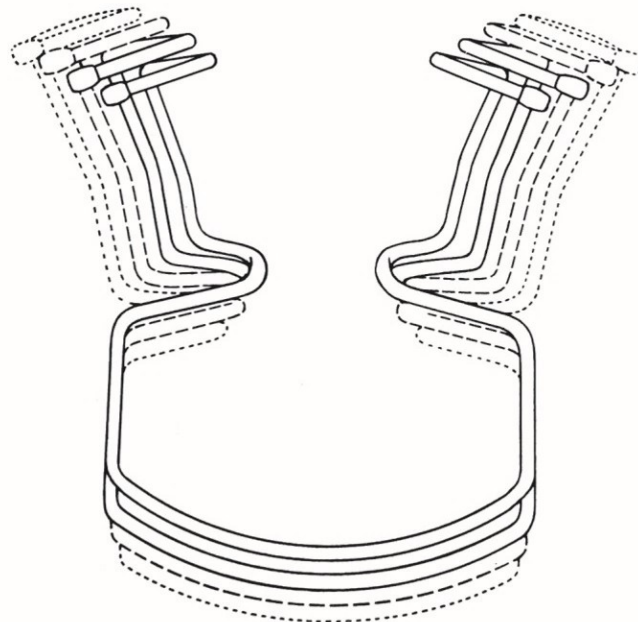

25-3507-11
10.5 cm / 4"



25-3508-14
14 cm / 5 1/2"



Sternberg
25-3509-14
14 cm / 5 1/2"
26 / 37 mm

Oral Maxillo Facial Surgery

Cheek Retractors
Wangenhalter

écarteurs
retractores de carrillos

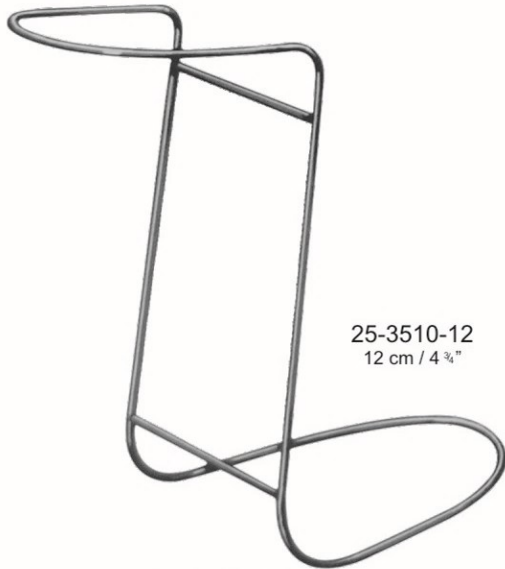

25-3510-12
12 cm / 4 3/4"

Obwegeser



25-3511-12
13.5 cm / 5 1/4"
27 mm

Bishop



25-3512-15
13.5 cm / 6"
20 mm

Cawood-Minnesota



25-3513-00
14.5 cm / 5 3/4"
Fenestrated
gefenstert
Fenestrated
fenestrados

Oral Maxillo Facial Surgery

Tongue Depressors
Zungenspatel

Abaisse-langue
depresores de lengua



25-3514-14
15 cm / 6"
88 x 25 mm

Tobold



25-3515-14
14.5 cm / 5 3/4"
85 x 24 mm

Tobold



25-3516-15
15 cm / 6 3/4"
72 x 23 mm

Hartmann

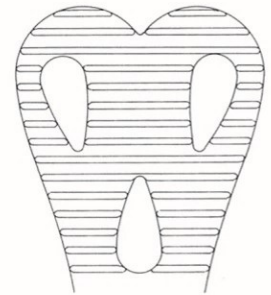

25-3517-01
14 cm / 5 1/2"
36 mm

Wieder

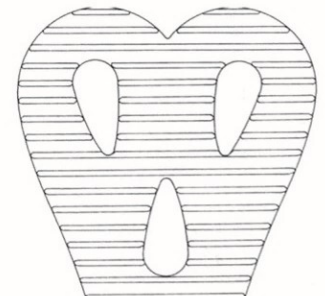

25-3517-02
15 cm / 6"
43 mm