

**AccuMed<sup>®</sup>**

CE



<http://accumedinstrument.com>

**Orthopedic Implants & Instruments**

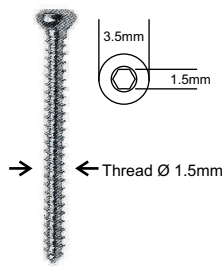

**CORTEX SCREW Ø 1.5MM**

Length in mm	Code S.S.	Code Titanium
6	ST-101.006	Ti-101.006
7	ST-101.007	Ti-101.007
8	ST-101.008	Ti-101.008
9	ST-101.009	Ti-101.009
10	ST-101.010	Ti-101.010
11	ST-101.011	Ti-101.011
12	ST-101.012	Ti-101.012
14	ST-101.014	Ti-101.014
16	ST-101.016	Ti-101.016
18	ST-101.018	Ti-101.018
20	ST-101.020	Ti-101.020

Drill Bit: 1.1mm

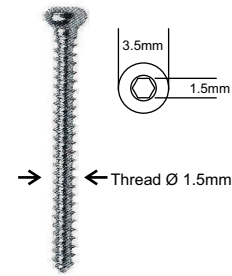

**CORTEX SCREW Ø 2.0MM**

Length in mm	Code S.S.	Code Titanium
6	ST-102.006	Ti-102.006
7	ST-102.007	Ti-102.007
8	ST-102.008	Ti-102.008
9	ST-102.009	Ti-102.009
10	ST-102.010	Ti-102.010
11	ST-102.011	Ti-102.011
12	ST-102.012	Ti-102.012
14	ST-102.014	Ti-102.014
16	ST-102.016	Ti-102.016
18	ST-102.018	Ti-102.018
20	ST-102.020	Ti-102.020

Drill Bit: 1.5mm

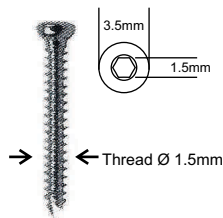

**CORTEX SCREW Ø 1.5MM  
SELF TAPPING**

Length in mm	Code S.S.	Code Titanium
6	ST-103.006	Ti-103.206
7	ST-103.007	Ti-103.207
8	ST-103.008	Ti-103.208
9	ST-103.009	Ti-103.209
10	ST-103.010	Ti-103.210
11	ST-103.011	Ti-103.211
12	ST-103.012	Ti-103.212
14	ST-103.014	Ti-103.214
16	ST-103.016	Ti-103.216
18	ST-103.018	Ti-103.218
20	ST-103.020	Ti-103.220

Drill Bit: 1.1mm

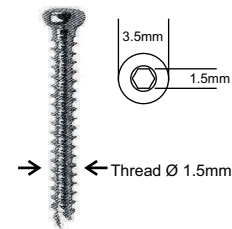

**CORTEX SCREW Ø 2.0MM  
SELF TAPPING**

Length in mm	Code S.S.	Code Titanium
6	ST-104.006	Ti-104.306
7	ST-104.007	Ti-104.307
8	ST-104.008	Ti-104.308
9	ST-104.009	Ti-104.309
10	ST-104.010	Ti-104.310
11	ST-104.011	Ti-104.311
12	ST-104.012	Ti-104.312
14	ST-104.014	Ti-104.314
16	ST-104.016	Ti-104.316
18	ST-104.018	Ti-104.318
20	ST-104.020	Ti-104.320

Drill Bit: 1.5mm

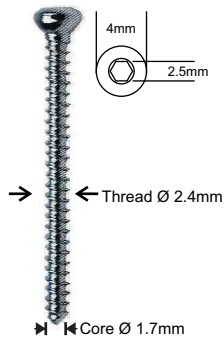

**CORTEX SCREW Ø 2.4MM**

Length in mm	Code S.S.	Code Titanium
6	ST-105.006	Ti-105.006
8	ST-105.008	Ti-105.008
10	ST-105.010	Ti-105.010
12	ST-105.012	Ti-105.012
14	ST-105.014	Ti-105.014
16	ST-105.016	Ti-105.016
18	ST-105.018	Ti-105.018
20	ST-105.020	Ti-105.020
22	ST-105.022	Ti-105.022
24	ST-105.024	Ti-105.024
26	ST-105.026	Ti-105.026
28	ST-105.028	Ti-105.028
30	ST-105.030	Ti-105.030

Drill Bit: 1.8mm

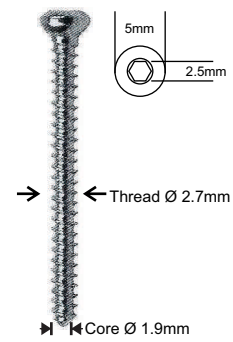

**CORTEX SCREW Ø 2.7MM**

Length in mm	Code S.S.	Code Titanium
6	ST-106.006	Ti-106.006
8	ST-106.008	Ti-106.008
10	ST-106.010	Ti-106.010
12	ST-106.012	Ti-106.012
14	ST-106.014	Ti-106.014
16	ST-106.016	Ti-106.016
18	ST-106.018	Ti-106.018
20	ST-106.020	Ti-106.020
22	ST-106.022	Ti-106.022
24	ST-106.024	Ti-106.024
26	ST-106.026	Ti-106.026
28	ST-106.028	Ti-106.028
30	ST-106.030	Ti-106.030

Drill Bit: 2mm  
Length 32 to 55mm available on request.

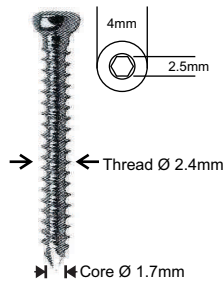

**CORTEX SCREW Ø 2.4MM  
SELF TAPPING**

Length in mm	Code S.S.	Code Titanium
6	ST-107.006	Ti-107.206
8	ST-107.008	Ti-107.208
10	ST-107.010	Ti-107.210
12	ST-107.012	Ti-107.212
14	ST-107.014	Ti-107.214
16	ST-107.016	Ti-107.216
18	ST-107.018	Ti-107.218
20	ST-107.020	Ti-107.220
22	ST-107.022	Ti-107.222
24	ST-107.024	Ti-107.224
26	ST-107.026	Ti-107.226
28	ST-107.028	Ti-107.228
30	ST-107.030	Ti-107.230

Drill Bit: 1.8mm

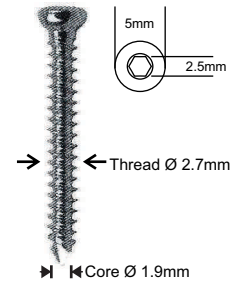

**CORTEX SCREW Ø 2.7MM  
SELF TAPPING**

Length in mm	Code S.S.	Code Titanium
6	ST-108.006	Ti-108.206
8	ST-108.008	Ti-108.208
10	ST-108.010	Ti-108.210
12	ST-108.012	Ti-108.212
14	ST-108.014	Ti-108.214
16	ST-108.016	Ti-108.216
18	ST-108.018	Ti-108.218
20	ST-108.020	Ti-108.220
22	ST-108.022	Ti-108.222
24	ST-108.024	Ti-108.224
26	ST-108.026	Ti-108.226
28	ST-108.028	Ti-108.228
30	ST-108.030	Ti-108.230

Drill Bit: 2mm  
Length 32 to 55mm available on request.

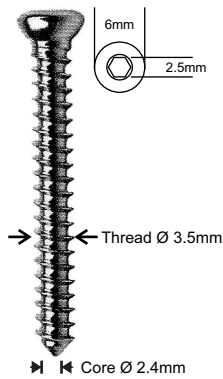

**CORTEX SCREW Ø 3.5MM**

Length in mm	Stainless Steel	Code Titanium
10	ST-109.010	Ti-109.010
12	ST-109.012	Ti-109.012
14	ST-109.014	Ti-109.014
16	ST-109.016	Ti-109.016
18	ST-109.018	Ti-109.018
20	ST-109.020	Ti-109.020
22	ST-109.022	Ti-109.022
24	ST-109.024	Ti-109.024
26	ST-109.026	Ti-109.026
28	ST-109.028	Ti-109.028
30	ST-109.030	Ti-109.030
32	ST-109.032	Ti-109.032
34	ST-109.034	Ti-109.034
36	ST-109.036	Ti-109.036
38	ST-109.038	Ti-109.038
40	ST-109.040	Ti-109.040
42	ST-109.042	Ti-109.042
44	ST-109.044	Ti-109.044
46	ST-109.046	Ti-109.046
48	ST-109.048	Ti-109.048
50	ST-109.050	Ti-109.050

Drill Bit: 2.5mm  
Drill Bit for Gliding Hole: 3.5mm

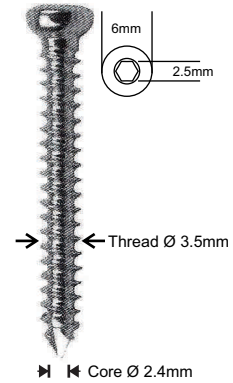

**CORTEX SCREW Ø 3.5MM, SELF TAPPING**

Length in mm	Stainless Steel	Code Titanium
10	ST-110.010	Ti-110.210
12	ST-110.012	Ti-110.212
14	ST-110.014	Ti-110.214
16	ST-110.016	Ti-110.216
18	ST-110.018	Ti-110.218
20	ST-110.020	Ti-110.220
22	ST-110.022	Ti-110.222
24	ST-110.024	Ti-110.224
26	ST-110.026	Ti-110.226
28	ST-110.028	Ti-110.228
30	ST-110.030	Ti-110.230
32	ST-110.032	Ti-110.232
34	ST-110.034	Ti-110.234
36	ST-110.036	Ti-110.236
38	ST-110.038	Ti-110.238
40	ST-110.040	Ti-110.240
42	ST-110.042	Ti-110.242
44	ST-110.044	Ti-110.244
46	ST-110.046	Ti-110.246
48	ST-110.048	Ti-110.248
50	ST-110.050	Ti-110.250

Drill Bit: 2.5mm  
Drill Bit for Gliding Hole: 3.5mm

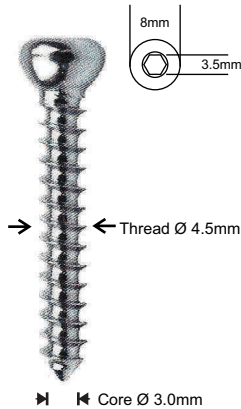

**CORTEX SCREW Ø 4.5MM**

Length in mm	Stainless Steel	Code Titanium
12	ST-111.012	Ti-111.012
14	ST-111.014	Ti-111.014
16	ST-111.016	Ti-111.016
18	ST-111.018	Ti-111.018
20	ST-111.020	Ti-111.020
22	ST-111.022	Ti-111.022
24	ST-111.024	Ti-111.024
26	ST-111.026	Ti-111.026
28	ST-111.028	Ti-111.028
30	ST-111.030	Ti-111.030
32	ST-111.032	Ti-111.032
34	ST-111.034	Ti-111.034
36	ST-111.036	Ti-111.036
38	ST-111.038	Ti-111.038
40	ST-111.040	Ti-111.040
42	ST-111.042	Ti-111.042
44	ST-111.044	Ti-111.044
46	ST-111.046	Ti-111.046
48	ST-111.048	Ti-111.048
50	ST-111.050	Ti-111.050
52	ST-111.052	Ti-111.052
54	ST-111.054	Ti-111.054
56	ST-111.056	Ti-111.056
58	ST-111.058	Ti-111.058
60	ST-111.060	Ti-111.060
62	ST-111.062	Ti-111.062
64	ST-111.064	Ti-111.064
66	ST-111.066	Ti-111.066
68	ST-111.068	Ti-111.068
70	ST-111.070	Ti-111.070
72	ST-111.072	Ti-111.072
74	ST-111.074	Ti-111.074
76	ST-111.076	Ti-111.076
78	ST-111.078	Ti-111.078
80	ST-111.080	Ti-111.080

Drill Bit: 3.2mm  
Drill bit for Gliding Hole: 4.5mm

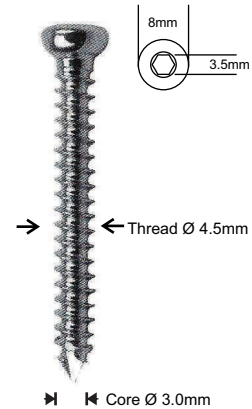

**CORTEX SCREW Ø 4.5MM - SELF TAPPING**

Length in mm	Stainless Steel	Code Titanium
12	ST-112.012	Ti-112.212
14	ST-112.014	Ti-112.214
16	ST-112.016	Ti-112.216
18	ST-112.018	Ti-112.218
20	ST-112.020	Ti-112.220
22	ST-112.022	Ti-112.222
24	ST-112.024	Ti-112.224
26	ST-112.026	Ti-112.226
28	ST-112.028	Ti-112.228
30	ST-112.030	Ti-112.230
32	ST-112.032	Ti-112.232
34	ST-112.034	Ti-112.234
36	ST-112.036	Ti-112.236
38	ST-112.038	Ti-112.238
40	ST-112.040	Ti-112.240
42	ST-112.042	Ti-112.242
44	ST-112.044	Ti-112.244
46	ST-112.046	Ti-112.246
48	ST-112.048	Ti-112.248
50	ST-112.050	Ti-112.250
52	ST-112.052	Ti-112.252
54	ST-112.054	Ti-112.254
56	ST-112.056	Ti-112.256
58	ST-112.058	Ti-112.258
60	ST-112.060	Ti-112.260
62	ST-112.062	Ti-112.262
64	ST-112.064	Ti-112.264
66	ST-112.066	Ti-112.266
68	ST-112.068	Ti-112.268
70	ST-112.070	Ti-112.270
72	ST-112.072	Ti-112.272
74	ST-112.074	Ti-112.274
76	ST-112.076	Ti-112.276
78	ST-112.078	Ti-112.278
80	ST-112.080	Ti-112.280

Drill Bit: 3.2mm  
Drill bit for Gliding Hole: 4.5mm

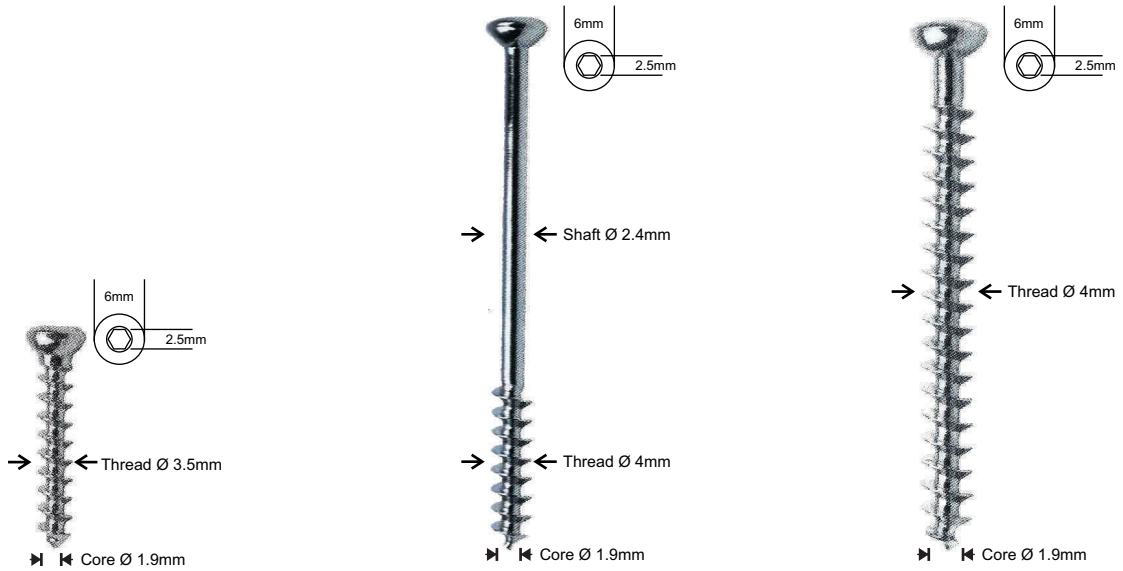

**CANCELLOUS BONE SCREW Ø 3.5MM**

Length in mm	Stainless Steel	Code Titanium
10	ST-121.010	Ti-121.010
12	ST-121.012	Ti-121.012
14	ST-121.014	Ti-121.014
16	ST-121.016	Ti-121.016
18	ST-121.018	Ti-121.018
20	ST-121.020	Ti-121.020
22	ST-121.022	Ti-121.022
24	ST-121.024	Ti-121.024
26	ST-121.026	Ti-121.026
28	ST-121.028	Ti-121.028
30	ST-121.030	Ti-121.030
35	ST-121.035	Ti-121.035
40	ST-121.040	Ti-121.040
45	ST-121.045	Ti-121.045
50	ST-121.050	Ti-121.050
55	ST-121.055	Ti-121.055
60	ST-121.060	Ti-121.060

Drill Bit: 2.5mm

**CANCELLOUS BONE SCREW Ø 4.0MM SHORT-THREAD**

Length in mm	Stainless Steel	Code Titanium
10	ST-124.010	Ti-124.010
12	ST-124.012	Ti-124.012
14	ST-124.014	Ti-124.014
16	ST-124.016	Ti-124.016
18	ST-124.018	Ti-124.018
20	ST-124.020	Ti-124.020
22	ST-124.022	Ti-124.022
24	ST-124.024	Ti-124.024
26	ST-124.026	Ti-124.026
28	ST-124.028	Ti-124.028
30	ST-124.030	Ti-124.030
35	ST-124.035	Ti-124.035
40	ST-124.040	Ti-124.040
45	ST-124.045	Ti-124.045
50	ST-124.050	Ti-124.050
55	ST-124.055	Ti-124.055
60	ST-124.060	Ti-124.060

Drill Bit: 2.5mm

**CANCELLOUS BONE SCREW Ø 4.0MM FULL-THREAD**

Length in mm	Stainless Steel	Code Titanium
10	ST-125.010	Ti-125.010
12	ST-125.012	Ti-125.012
14	ST-125.014	Ti-125.014
16	ST-125.016	Ti-125.016
18	ST-125.018	Ti-125.018
20	ST-125.020	Ti-125.020
22	ST-125.022	Ti-125.022
24	ST-125.024	Ti-125.024
26	ST-125.026	Ti-125.026
28	ST-125.028	Ti-125.028
30	ST-125.030	Ti-125.030
35	ST-125.035	Ti-125.035
40	ST-125.040	Ti-125.040
45	ST-125.045	Ti-125.045
50	ST-125.050	Ti-125.050
55	ST-125.055	Ti-125.055
60	ST-125.060	Ti-125.060

Drill Bit: 2.5mm



**CANCELLOUS BONE SCREW Ø 4.5MM  
SHORT-THREAD**

Length in mm	Stainless Steel	Code Titanium
10	ST-151.010	Ti-151.010
12	ST-151.012	Ti-151.012
14	ST-151.014	Ti-151.014
16	ST-151.016	Ti-151.016
18	ST-151.018	Ti-151.018
20	ST-151.020	Ti-151.020
22	ST-151.022	Ti-151.022
24	ST-151.024	Ti-151.024
26	ST-151.026	Ti-151.026
28	ST-151.028	Ti-151.028
30	ST-151.030	Ti-151.030
35	ST-151.035	Ti-151.035
40	ST-151.040	Ti-151.040
45	ST-151.045	Ti-151.045
50	ST-151.050	Ti-151.050
55	ST-151.055	Ti-151.055
60	ST-151.060	Ti-151.060

Drill Bit: 2.5mm

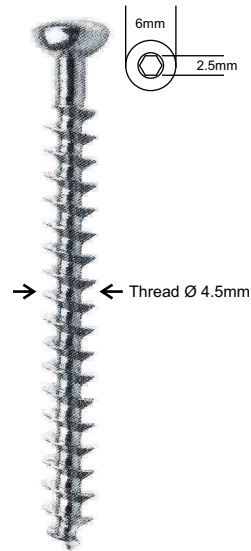

**CANCELLOUS BONE SCREW Ø 4.5MM  
FULL-THREAD**

Length in mm	Stainless Steel	Code Titanium
10	ST-152.010	Ti-152.010
12	ST-152.012	Ti-152.012
14	ST-152.014	Ti-152.014
16	ST-152.016	Ti-152.016
18	ST-152.018	Ti-152.018
20	ST-152.020	Ti-152.020
22	ST-152.022	Ti-152.022
24	ST-152.024	Ti-152.024
26	ST-152.026	Ti-152.026
28	ST-152.028	Ti-152.028
30	ST-152.030	Ti-152.030
35	ST-152.035	Ti-152.035
40	ST-152.040	Ti-152.040
45	ST-152.045	Ti-152.045
50	ST-152.050	Ti-152.050
55	ST-152.055	Ti-152.055
60	ST-152.060	Ti-152.060

Drill Bit: 2.5mm

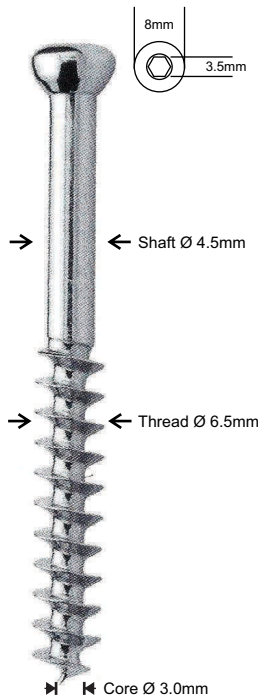

**CANCELLOUS BONE SCREW  
Ø 6.5MM, 32MM THREAD**

Length in mm	Stainless Steel	Code Titanium
40	ST-122.040	Ti-122.040
45	ST-122.045	Ti-122.045
50	ST-122.050	Ti-122.050
55	ST-122.055	Ti-122.055
60	ST-122.060	Ti-122.060
65	ST-122.065	Ti-122.065
70	ST-122.070	Ti-122.070
75	ST-122.075	Ti-122.075
80	ST-122.080	Ti-122.080
85	ST-122.085	Ti-122.085
90	ST-122.090	Ti-122.090
95	ST-122.095	Ti-122.095
100	ST-122.100	Ti-122.100
105	ST-122.105	Ti-122.105
110	ST-122.110	Ti-122.110
115	ST-122.115	Ti-122.115
120	ST-122.120	Ti-122.120

Drill Bit: 3.2mm

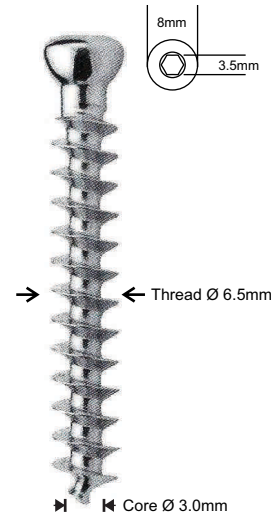

**CANCELLOUS BONE SCREW  
Ø 6.5MM, FULLY THREAD**

Length in mm	Stainless Steel	Code Titanium
25	ST-123.025	Ti-123.025
30	ST-123.030	Ti-123.030
35	ST-123.035	Ti-123.035
40	ST-123.040	Ti-123.040
45	ST-123.045	Ti-123.045
50	ST-123.050	Ti-123.050
55	ST-123.055	Ti-123.055
60	ST-123.060	Ti-123.060
65	ST-123.065	Ti-123.065
70	ST-123.070	Ti-123.070
75	ST-123.075	Ti-123.075
80	ST-123.080	Ti-123.080
85	ST-123.085	Ti-123.085
90	ST-123.090	Ti-123.090
95	ST-123.095	Ti-123.095
100	ST-123.100	Ti-123.100
105	ST-123.105	Ti-123.105
110	ST-123.110	Ti-123.110
115	ST-123.115	Ti-123.115
120	ST-123.120	Ti-123.120

Drill Bit: 3.2mm

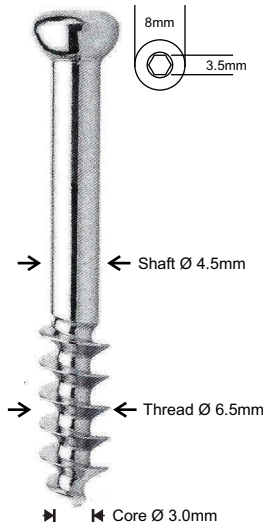

**CANCELLOUS BONE SCREW  
Ø 6.5MM, 16MM THREAD**

Length in mm	Stainless Steel	Code Titanium
25	ST-126.025	Ti-126.025
30	ST-126.030	Ti-126.030
35	ST-126.035	Ti-126.035
40	ST-126.040	Ti-126.040
45	ST-126.045	Ti-126.045
50	ST-126.050	Ti-126.050
55	ST-126.055	Ti-126.055
60	ST-126.060	Ti-126.060
65	ST-126.065	Ti-126.065
70	ST-126.070	Ti-126.070
75	ST-126.075	Ti-126.075
80	ST-126.080	Ti-126.080
85	ST-126.085	Ti-126.085
90	ST-126.090	Ti-126.090
95	ST-126.095	Ti-126.095
100	ST-126.100	Ti-126.100
105	ST-126.105	Ti-126.105
110	ST-126.110	Ti-126.110
115	ST-126.115	Ti-126.115
120	ST-126.120	Ti-126.120

Drill Bit: 3.2mm  
Drill Bit for Gliding Hole: 4.5mm

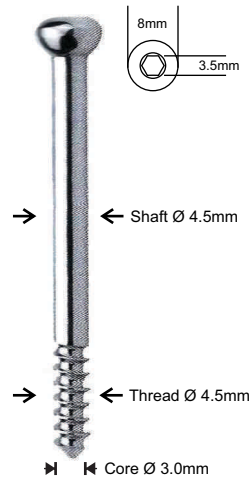

**SHAFT SCREW Ø 4.5MM**

Total Length in mm	Thread Length in mm	Stainless Steel	Code Titanium
22	12	ST-141.022	Ti-141.022
24	12	ST-141.024	Ti-141.024
26	12	ST-141.026	Ti-141.026
28	12	ST-141.028	Ti-141.028
30	12	ST-141.030	Ti-141.030
32	12	ST-141.032	Ti-141.032
34	12	ST-141.034	Ti-141.034
36	12	ST-141.036	Ti-141.036
38	12	ST-141.038	Ti-141.038
40	12	ST-141.040	Ti-141.040
42	12	ST-141.042	Ti-141.042
44	12	ST-141.044	Ti-141.044
46	12	ST-141.046	Ti-141.046
48	12	ST-141.048	Ti-141.048
50	12	ST-141.050	Ti-141.050
55	15	ST-141.055	Ti-141.055
60	15	ST-141.060	Ti-141.060
65	18	ST-141.065	Ti-141.065
70	18	ST-141.070	Ti-141.070
75	18	ST-141.075	Ti-141.075
80	18	ST-141.080	Ti-141.080
85	22	ST-141.085	Ti-141.085
90	22	ST-141.090	Ti-141.090
95	26	ST-141.095	Ti-141.095
100	26	ST-141.100	Ti-141.100

Drill Bit: 3.2mm  
Drill Bit for Gliding Hole: 4.5mm  
For LCDCP Plates

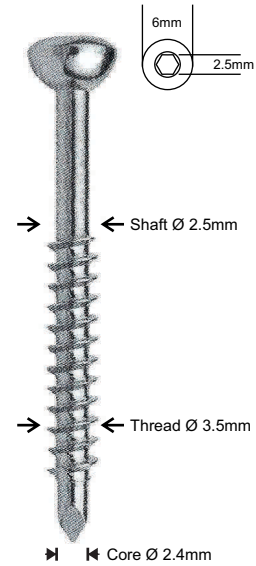
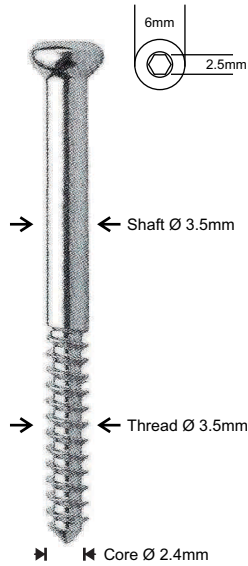

**SHAFT SCREW Ø 3.5MM**

Length in mm	Stainless Steel	Code Titanium
12	ST-124.012	Ti-124.012
14	ST-124.014	Ti-124.014
16	ST-124.016	Ti-124.016
18	ST-124.018	Ti-124.018
20	ST-124.020	Ti-124.020
22	ST-124.022	Ti-124.022
24	ST-124.024	Ti-124.024
26	ST-124.026	Ti-124.026
28	ST-124.028	Ti-124.028
30	ST-124.030	Ti-124.030
32	ST-124.032	Ti-124.032
34	ST-124.034	Ti-124.034
36	ST-124.036	Ti-124.036
38	ST-124.038	Ti-124.038
40	ST-124.040	Ti-124.040
45	ST-124.045	Ti-124.045
50	ST-124.050	Ti-124.050
55	ST-124.055	Ti-124.055
60	ST-124.060	Ti-124.060

For low contact dynamic compression plate  
Drill Bit for Gliding Hole: 3.5mm  
Drill Bit: 2.5mm

**MALLEOLAR SCREW Ø 3.5MM**

Length in mm	Stainless Steel	Code Titanium
25	ST-161.025	Ti-161.225
30	ST-161.030	Ti-161.230
35	ST-161.035	Ti-161.235
40	ST-161.040	Ti-161.240
45	ST-161.045	Ti-161.245
50	ST-161.050	Ti-161.250
55	ST-161.055	Ti-161.255
60	ST-161.060	Ti-161.260
65	ST-161.065	Ti-161.265
70	ST-161.070	Ti-161.270

Drill Bit: 2.5mm  
Drill Bit for Gliding Hole: 3.5mm



**SAFETY LOCK SCREW  
Ø 2.4MM - SELF TAPPING**

Length in mm	Stainless Steel	Code Titanium
6	ST-171.006	Ti-171.006
8	ST-171.008	Ti-171.008
10	ST-171.010	Ti-171.010
12	ST-171.012	Ti-171.012
14	ST-171.014	Ti-171.014
16	ST-171.016	Ti-171.016
18	ST-171.018	Ti-171.018
20	ST-171.020	Ti-171.020
22	ST-171.022	Ti-171.022
24	ST-171.024	Ti-171.024
26	ST-171.026	Ti-171.026
28	ST-171.028	Ti-171.028
30	ST-171.030	Ti-171.030

Drill Bit: 1.8mm



**SAFETY LOCK SCREW  
Ø 2.7MM - SELF TAPPING**

Length in mm	Stainless Steel	Code Titanium
20	ST-172.020	Ti-172.420
22	ST-172.022	Ti-172.422
24	ST-172.024	Ti-172.424
26	ST-172.026	Ti-172.426
28	ST-172.028	Ti-172.428
30	ST-172.030	Ti-172.430
32	ST-172.032	Ti-172.432
34	ST-172.034	Ti-172.434
36	ST-172.036	Ti-172.436
38	ST-172.038	Ti-172.438
40	ST-172.040	Ti-172.440
42	ST-172.042	Ti-172.442
44	ST-172.044	Ti-172.444
46	ST-172.046	Ti-172.446
48	ST-172.048	Ti-172.448
50	ST-172.050	Ti-172.450
52	ST-172.052	Ti-172.452
54	ST-172.054	Ti-172.454
56	ST-172.056	Ti-172.456
58	ST-172.058	Ti-172.458
60	ST-172.060	Ti-172.460

Drill Bit: 2.0mm

**SAFETY LOCK SCREW  
Ø 3.5MM - SELF TAPPING**

Length in mm	Stainless Steel	Code Titanium
10	ST-173.010	Ti-173.210
12	ST-173.012	Ti-173.212
14	ST-173.014	Ti-173.214
16	ST-173.016	Ti-173.216
18	ST-173.018	Ti-173.218
20	ST-173.020	Ti-173.220
22	ST-173.022	Ti-173.222
24	ST-173.024	Ti-173.224
26	ST-173.026	Ti-173.226
28	ST-173.028	Ti-173.228
30	ST-173.030	Ti-173.230
32	ST-173.032	Ti-173.232
34	ST-173.034	Ti-173.234
36	ST-173.036	Ti-173.236
38	ST-173.038	Ti-173.238
40	ST-173.040	Ti-173.240
42	ST-173.042	Ti-173.242
44	ST-173.044	Ti-173.244
46	ST-173.046	Ti-173.246
48	ST-173.048	Ti-173.248
50	ST-173.050	Ti-173.250
52	ST-173.052	Ti-173.252
54	ST-173.054	Ti-173.254
56	ST-173.056	Ti-173.256
58	ST-173.058	Ti-173.258
60	ST-173.060	Ti-173.260

Drill Bit: 2.8mm



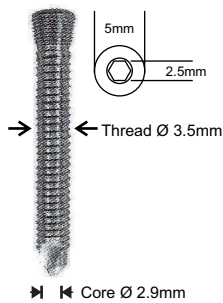

### SAFETY LOCK SCREW Ø 3.5MM SELF TAPPING & SELF DRILLING

Length in mm	Stainless Steel	Code Titanium
10	ST-174.010	Ti-174.410
12	ST-174.012	Ti-174.412
14	ST-174.014	Ti-174.414
16	ST-174.016	Ti-174.416
18	ST-174.018	Ti-174.418
20	ST-174.020	Ti-174.420
22	ST-174.022	Ti-174.422
24	ST-174.024	Ti-174.424
26	ST-174.026	Ti-174.426
28	ST-174.028	Ti-174.428
30	ST-174.030	Ti-174.430
32	ST-174.032	Ti-174.432
34	ST-174.034	Ti-174.434
36	ST-174.036	Ti-174.436
38	ST-174.038	Ti-174.438
40	ST-174.040	Ti-174.440
42	ST-174.042	Ti-174.442
44	ST-174.044	Ti-174.444
46	ST-174.046	Ti-174.446
48	ST-174.048	Ti-174.448
50	ST-174.050	Ti-174.450
52	ST-174.052	Ti-174.452
54	ST-174.054	Ti-174.454
56	ST-174.056	Ti-174.456
58	ST-174.058	Ti-174.458
60	ST-174.060	Ti-174.460

Drill Bit: 2.8mm

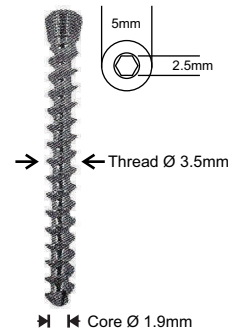

### CANCELLOUS SAFETY LOCK SCREW Ø 3.5MM - SELF TAPPING

Length in mm	Stainless Steel	Code Titanium
10	ST-131.010	Ti-131.510
12	ST-131.012	Ti-131.512
14	ST-131.014	Ti-131.514
16	ST-131.016	Ti-131.516
18	ST-131.018	Ti-131.518
20	ST-131.020	Ti-131.520
22	ST-131.022	Ti-131.522
24	ST-131.024	Ti-131.524
26	ST-131.026	Ti-131.526
28	ST-131.028	Ti-131.528
30	ST-131.030	Ti-131.530
32	ST-131.032	Ti-131.532
34	ST-131.034	Ti-131.534
36	ST-131.036	Ti-131.536
38	ST-131.038	Ti-131.538
40	ST-131.040	Ti-131.540
42	ST-131.042	Ti-131.542
44	ST-131.044	Ti-131.544
46	ST-131.046	Ti-131.546
48	ST-131.048	Ti-131.548
50	ST-131.050	Ti-131.550
52	ST-131.052	Ti-131.552
54	ST-131.054	Ti-131.554
56	ST-131.056	Ti-131.556
58	ST-131.058	Ti-131.558
60	ST-131.060	Ti-131.560

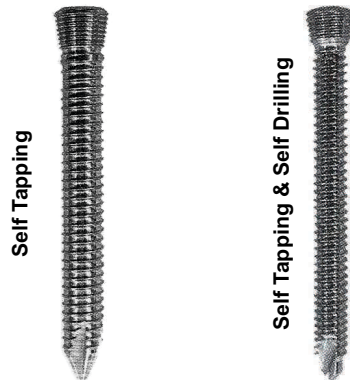

**SAFETY LOCK SCREW Ø 5.0MM**

**STAINLESS STEEL**

Length in mm	Self Tapping	Self Tapping & Self Drilling
12	ST-175.012	ST-175.212
14	ST-175.014	ST-175.214
16	ST-175.016	ST-175.216
18	ST-175.018	ST-175.218
20	ST-175.020	ST-175.220
22	ST-175.022	ST-175.222
24	ST-175.024	ST-175.224
26	ST-175.026	ST-175.226
28	ST-175.028	ST-175.228
30	ST-175.030	ST-175.230
32	ST-175.032	ST-175.232
34	ST-175.034	ST-175.234
36	ST-175.036	ST-175.236
38	ST-175.038	ST-175.238
40	ST-175.040	ST-175.240
42	ST-175.042	ST-175.242
44	ST-175.044	ST-175.244
46	ST-175.046	ST-175.246
48	ST-175.048	ST-175.248
50	ST-175.050	ST-175.250
55	ST-175.055	ST-175.255
60	ST-175.060	ST-175.260
65	ST-175.065	ST-175.265
70	ST-175.070	ST-175.270
75	ST-175.075	ST-175.275
80	ST-175.080	ST-175.280
85	ST-175.085	ST-175.285
90	ST-175.090	ST-175.290

Drill Bit: 4.3mm

**TITANIUM**

Length in mm	Self Tapping	Self Tapping & Self Drilling
12	Ti-175.012	Ti-175.212
14	Ti-175.014	Ti-175.214
16	Ti-175.016	Ti-175.216
18	Ti-175.018	Ti-175.218
20	Ti-175.020	Ti-175.220
22	Ti-175.022	Ti-175.222
24	Ti-175.024	Ti-175.224
26	Ti-175.026	Ti-175.226
28	Ti-175.028	Ti-175.228
30	Ti-175.030	Ti-175.230
32	Ti-175.032	Ti-175.232
34	Ti-175.034	Ti-175.234
36	Ti-175.036	Ti-175.236
38	Ti-175.038	Ti-175.238
40	Ti-175.040	Ti-175.240
42	Ti-175.042	Ti-175.242
44	Ti-175.044	Ti-175.244
46	Ti-175.046	Ti-175.246
48	Ti-175.048	Ti-175.248
50	Ti-175.050	Ti-175.250
55	Ti-175.055	Ti-175.255
60	Ti-175.060	Ti-175.260
65	Ti-175.065	Ti-175.265
70	Ti-175.070	Ti-175.270
75	Ti-175.075	Ti-175.275
80	Ti-175.080	Ti-175.280
85	Ti-175.085	Ti-175.285
90	Ti-175.090	Ti-175.290

Drill Bit: 4.3mm



**CANCELLOUS SAFETY LOCK SCREW Ø 5.0MM**

Length in mm	Code - Full Thread		Code - 16mm Thread		Code - 32mm Thread	
	S.S.	TITANIUM	S.S.	TITANIUM	S.S.	TITANIUM
25	ST-132.025	Ti-132.725	ST-132.025	Ti-132.325	-	-
30	ST-132.030	Ti-132.730	ST-132.030	Ti-132.330	-	-
35	ST-132.035	Ti-132.735	ST-132.035	Ti-132.335	-	-
40	ST-132.040	Ti-132.740	ST-132.040	Ti-132.340	ST-132.040	Ti-132.540
45	ST-132.045	Ti-132.745	ST-132.045	Ti-132.345	ST-132.045	Ti-132.545
50	ST-132.050	Ti-132.750	ST-132.050	Ti-132.350	ST-132.050	Ti-132.550
55	ST-132.055	Ti-132.755	ST-132.055	Ti-132.355	ST-132.055	Ti-132.555
60	ST-132.060	Ti-132.760	ST-132.060	Ti-132.360	ST-132.060	Ti-132.560
65	ST-132.065	Ti-132.765	ST-132.065	Ti-132.365	ST-132.065	Ti-132.565
70	ST-132.070	Ti-132.770	ST-132.070	Ti-132.370	ST-132.070	Ti-132.570
75	ST-132.075	Ti-132.775	ST-132.075	Ti-132.375	ST-132.075	Ti-132.575
80	ST-132.080	Ti-132.780	ST-132.080	Ti-132.380	ST-132.080	Ti-132.580
85	ST-132.085	Ti-132.785	ST-132.085	Ti-132.385	ST-132.085	Ti-132.585
90	ST-132.090	Ti-132.790	ST-132.090	Ti-132.390	ST-132.090	Ti-132.590
95	ST-132.095	Ti-132.795	ST-132.095	Ti-132.395	ST-132.095	Ti-132.595
100	ST-132.100	Ti-132.800	ST-132.100	Ti-132.400	ST-132.100	Ti-132.600
105	ST-132.105	Ti-132.805	ST-132.105	Ti-132.405	ST-132.105	Ti-132.605
110	ST-132.110	Ti-132.810	ST-132.110	Ti-132.410	ST-132.110	Ti-132.610
115	ST-132.115	Ti-132.815	ST-132.115	Ti-132.415	ST-132.115	Ti-132.615
120	ST-132.120	Ti-132.820	ST-132.120	Ti-132.420	ST-132.120	Ti-132.620



**CANNULATED CANCELLOUS SAFETY LOCK SCREW Ø 5.0MM**

Length in mm	Code - Full Thread		Code - 16mm Thread		Code - 32mm Thread	
	S.S.	TITANIUM	S.S.	TITANIUM	S.S.	TITANIUM
25	ST-180.025	Ti-180.725	ST-180.025	Ti-180.325	-	-
30	ST-180.030	Ti-180.730	ST-180.030	Ti-180.330	-	-
35	ST-180.035	Ti-180.735	ST-180.035	Ti-180.335	-	-
40	ST-180.040	Ti-180.740	ST-180.040	Ti-180.340	ST-180.040	Ti-180.540
45	ST-180.045	Ti-180.745	ST-180.045	Ti-180.345	ST-180.045	Ti-180.545
50	ST-180.050	Ti-180.750	ST-180.050	Ti-180.350	ST-180.050	Ti-180.550
55	ST-180.055	Ti-180.755	ST-180.055	Ti-180.355	ST-180.055	Ti-180.555
60	ST-180.060	Ti-180.760	ST-180.060	Ti-180.360	ST-180.060	Ti-180.560
65	ST-180.065	Ti-180.765	ST-180.065	Ti-180.365	ST-180.065	Ti-180.565
70	ST-180.070	Ti-180.770	ST-180.070	Ti-180.370	ST-180.070	Ti-180.570
75	ST-180.075	Ti-180.775	ST-180.075	Ti-180.375	ST-180.075	Ti-180.575
80	ST-180.080	Ti-180.780	ST-180.080	Ti-180.380	ST-180.080	Ti-180.580
85	ST-180.085	Ti-180.785	ST-180.085	Ti-180.385	ST-180.085	Ti-180.585
90	ST-180.090	Ti-180.790	ST-180.090	Ti-180.390	ST-180.090	Ti-180.590
95	ST-180.095	Ti-180.795	ST-180.095	Ti-180.395	ST-180.095	Ti-180.595
100	ST-180.100	Ti-180.800	ST-180.100	Ti-180.400	ST-180.100	Ti-180.600
105	ST-180.105	Ti-180.805	ST-180.105	Ti-180.405	ST-180.105	Ti-180.605
110	ST-180.110	Ti-180.810	ST-180.110	Ti-180.410	ST-180.110	Ti-180.610
115	ST-180.115	Ti-180.815	ST-180.115	Ti-180.415	ST-180.115	Ti-180.615
120	ST-180.120	Ti-180.820	ST-180.120	Ti-180.420	ST-180.120	Ti-180.620

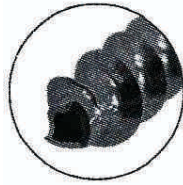

**CANNULATED SAFETY LOCK SCREW Ø 5.0MM**

Length in mm	Code - Full Thread		Code - 16mm Thread		Code - 32mm Thread	
	S.S.	TITANIUM	S.S.	TITANIUM	S.S.	TITANIUM
25	ST-190.025	Ti-190.725	ST-190.025	Ti-190.325	-	-
30	ST-190.030	Ti-190.730	ST-190.030	Ti-190.330	-	-
35	ST-190.035	Ti-190.735	ST-190.035	Ti-190.335	-	-
40	ST-190.040	Ti-190.740	ST-190.040	Ti-190.340	ST-190.040	Ti-190.540
45	ST-190.045	Ti-190.745	ST-190.045	Ti-190.345	ST-190.045	Ti-190.545
50	ST-190.050	Ti-190.750	ST-190.050	Ti-190.350	ST-190.050	Ti-190.550
55	ST-190.055	Ti-190.755	ST-190.055	Ti-190.355	ST-190.055	Ti-190.555
60	ST-190.060	Ti-190.760	ST-190.060	Ti-190.360	ST-190.060	Ti-190.560
65	ST-190.065	Ti-190.765	ST-190.065	Ti-190.365	ST-190.065	Ti-190.565
70	ST-190.070	Ti-190.770	ST-190.070	Ti-190.370	ST-190.070	Ti-190.570
75	ST-190.075	Ti-190.775	ST-190.075	Ti-190.375	ST-190.075	Ti-190.575
80	ST-190.080	Ti-190.780	ST-190.080	Ti-190.380	ST-190.080	Ti-190.580
85	ST-190.085	Ti-190.785	ST-190.085	Ti-190.385	ST-190.085	Ti-190.585
90	ST-190.090	Ti-190.790	ST-190.090	Ti-190.390	ST-190.090	Ti-190.590
95	ST-190.095	Ti-190.795	ST-190.095	Ti-190.395	ST-190.095	Ti-190.595
100	ST-190.100	Ti-190.800	ST-190.100	Ti-190.400	ST-190.100	Ti-190.600
105	ST-190.105	Ti-190.805	ST-190.105	Ti-190.405	ST-190.105	Ti-190.605
110	ST-190.110	Ti-190.810	ST-190.110	Ti-190.410	ST-190.110	Ti-190.610
115	ST-190.115	Ti-190.815	ST-190.115	Ti-190.415	ST-190.115	Ti-190.615
120	ST-190.120	Ti-190.820	ST-190.120	Ti-190.420	ST-190.120	Ti-190.620

Cannulated Drill Bit : 4.3mm

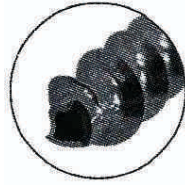

**CANNULATED SAFETY LOCK SCREW Ø 6.5MM**

Length in mm	Code - Full Thread		Code - 16mm Thread		Code - 32mm Thread	
	S.S.	TITANIUM	S.S.	TITANIUM	S.S.	TITANIUM
25	ST-191.025	Ti-191.125	ST-191.025	Ti-191.325	-	-
30	ST-191.030	Ti-191.130	ST-191.030	Ti-191.330	-	-
35	ST-191.035	Ti-191.135	ST-191.035	Ti-191.335	-	-
40	ST-191.040	Ti-191.140	ST-191.040	Ti-191.340	ST-191.040	Ti-191.540
45	ST-191.045	Ti-191.145	ST-191.045	Ti-191.345	ST-191.045	Ti-191.545
50	ST-191.050	Ti-191.150	ST-191.050	Ti-191.350	ST-191.050	Ti-191.550
55	ST-191.055	Ti-191.155	ST-191.055	Ti-191.355	ST-191.055	Ti-191.555
60	ST-191.060	Ti-191.160	ST-191.060	Ti-191.360	ST-191.060	Ti-191.560
65	ST-191.065	Ti-191.165	ST-191.065	Ti-191.365	ST-191.065	Ti-191.565
70	ST-191.070	Ti-191.170	ST-191.070	Ti-191.370	ST-191.070	Ti-191.570
75	ST-191.075	Ti-191.175	ST-191.075	Ti-191.375	ST-191.075	Ti-191.575
80	ST-191.080	Ti-191.180	ST-191.080	Ti-191.380	ST-191.080	Ti-191.580
85	ST-191.085	Ti-191.185	ST-191.085	Ti-191.385	ST-191.085	Ti-191.585
90	ST-191.090	Ti-191.190	ST-191.090	Ti-191.390	ST-191.090	Ti-191.590
95	ST-191.095	Ti-191.195	ST-191.095	Ti-191.395	ST-191.095	Ti-191.595
100	ST-191.100	Ti-191.200	ST-191.100	Ti-191.400	ST-191.100	Ti-191.600
105	ST-191.105	Ti-191.205	ST-191.105	Ti-191.405	ST-191.105	Ti-191.605
110	ST-191.110	Ti-191.210	ST-191.110	Ti-191.410	ST-191.110	Ti-191.610
115	ST-191.115	Ti-191.215	ST-191.115	Ti-191.415	ST-191.115	Ti-191.615
120	ST-191.120	Ti-191.220	ST-191.120	Ti-191.420	ST-191.120	Ti-191.620

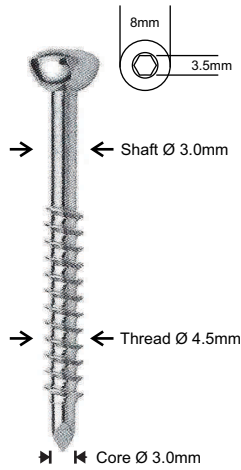

**MALLEOLAR SCREW Ø 4.5MM**

Total Length in mm	Thread Length in mm	Stainless Steel	Code Titanium
25	12	ST-162.025	Ti-162.025
30	16	ST-162.030	Ti-162.030
35	18	ST-162.035	Ti-162.035
40	20	ST-162.040	Ti-162.040
45	22	ST-162.045	Ti-162.045
50	24	ST-162.050	Ti-162.050
55	26	ST-162.055	Ti-162.055
60	28	ST-162.060	Ti-162.060
65	30	ST-162.065	Ti-162.065
70	32	ST-162.070	Ti-162.070
75	34	ST-162.075	Ti-162.075
80	36	ST-162.080	Ti-162.080
85	38	ST-162.085	Ti-162.085
90	40	ST-162.090	Ti-162.090
95	42	ST-162.095	Ti-162.095
100	44	ST-162.100	Ti-162.100

Drill Bit: 3.2mm  
Drill Bit for Gliding Hole: 4.5mm



**Washer for 4.5 to 7.0mm Screws**  
**Stainless Steel**  
Code No.: ST-100.020

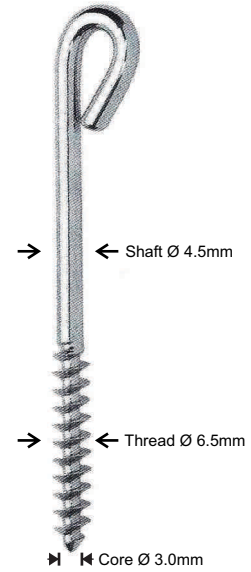

**CANCELLOUS TRACTION BONE SCREW**  
**Ø 6.5MM**

Length in mm	Stainless Steel	Code Titanium
45	ST-150.045	Ti-150.245
50	ST-150.050	Ti-150.250
55	ST-150.055	Ti-150.255
60	ST-150.060	Ti-150.260
65	ST-150.065	Ti-150.265
70	ST-150.070	Ti-150.270
75	ST-150.075	Ti-150.275
80	ST-150.080	Ti-150.280
85	ST-150.085	Ti-150.285
90	ST-150.090	Ti-150.290
95	ST-150.095	Ti-150.295
100	ST-150.100	Ti-150.300
105	ST-150.105	Ti-150.305
110	ST-150.110	Ti-150.310
115	ST-150.115	Ti-150.315
120	ST-150.120	Ti-150.320
125	ST-150.125	Ti-150.325
130	ST-150.130	Ti-150.330
135	ST-150.135	Ti-150.335

Drill Bit: 3.2mm



**Washer for 4.5 to 7.0mm Screws**  
**Titanium**  
Code No.: Ti-100.020

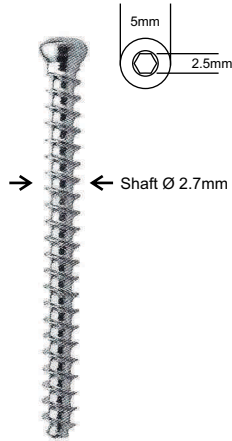
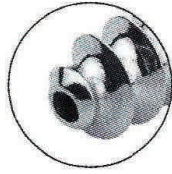

**CORTEX CANNULATED SCREW Ø 2.7MM  
FULL THREAD**

Length in mm	Standard S.S.	Self Tapping S.S.	Standard Titanium	Self Tapping Titanium
17	ST-201.017	ST-202.017	Ti-201.217	Ti-202.217
18	ST-201.018	ST-202.018	Ti-201.218	Ti-202.218
19	ST-201.019	ST-202.019	Ti-201.219	Ti-202.219
20	ST-201.020	ST-202.020	Ti-201.220	Ti-202.220
22	ST-201.022	ST-202.022	Ti-201.222	Ti-202.222
24	ST-201.024	ST-202.024	Ti-201.224	Ti-202.224
26	ST-201.026	ST-202.026	Ti-201.226	Ti-202.226
28	ST-201.028	ST-202.028	Ti-201.228	Ti-202.228
30	ST-201.030	ST-202.030	Ti-201.230	Ti-202.230

Drill Bit: 2.0mm

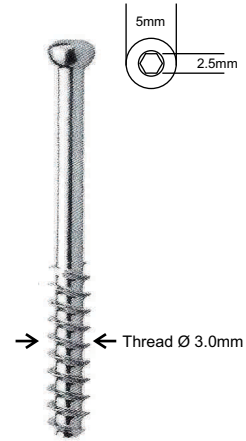
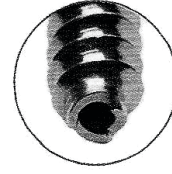

**CANNULATED SCREW Ø 3.0MM  
SHORT THREAD**

Total Length in mm	Thread Length in mm	Stainless Steel	Code Titanium
8	4	ST-211.008	Ti-211.208
9	4	ST-211.009	Ti-211.209
10	4	ST-211.010	Ti-211.210
11	4	ST-211.011	Ti-211.211
12	4	ST-211.012	Ti-211.212
13	4	ST-211.013	Ti-211.213
14	4	ST-211.014	Ti-211.214
15	4	ST-211.015	Ti-211.215
16	4	ST-211.016	Ti-211.216
17	4	ST-211.017	Ti-211.217
18	5	ST-211.018	Ti-211.218
19	5	ST-211.019	Ti-211.219
20	5	ST-211.020	Ti-211.220
21	5	ST-211.021	Ti-211.221
22	5	ST-211.022	Ti-211.222
23	5	ST-211.023	Ti-211.223
24	6	ST-211.024	Ti-211.224
25	6	ST-211.025	Ti-211.225
26	6	ST-211.026	Ti-211.226
27	6	ST-211.027	Ti-211.227
28	6	ST-211.028	Ti-211.228
29	6	ST-211.029	Ti-211.229
30	6	ST-211.030	Ti-211.230
32	6	ST-211.032	Ti-211.232
34	7	ST-211.034	Ti-211.234
36	7	ST-211.036	Ti-211.236
38	8	ST-211.038	Ti-211.238
40	8	ST-211.040	Ti-211.240
42	8	ST-211.042	Ti-211.242
44	9	ST-211.044	Ti-211.244
46	9	ST-211.046	Ti-211.246
48	10	ST-211.048	Ti-211.248
50	10	ST-211.050	Ti-211.250

Drill Bit: 2.0mm

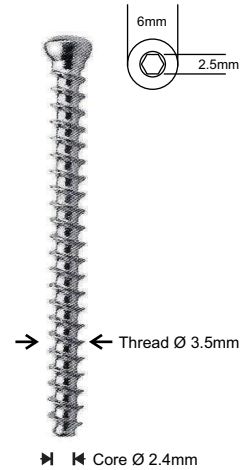
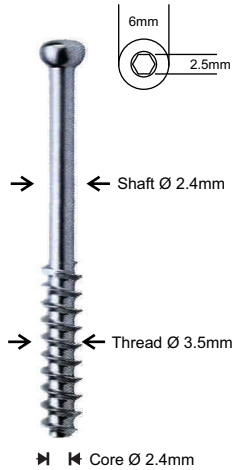
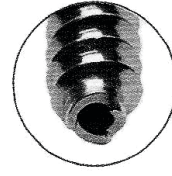
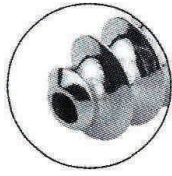

### CORTEX CANNULATED SCREW Ø 3.5MM PARTIAL THREAD

Length in mm	Standard S.S.	Self Tapping S.S.	Standard Titanium	Self Tapping Titanium
10	ST-203.010	ST-204.010	Ti-203.110	Ti-204.110
12	ST-203.012	ST-204.012	Ti-203.112	Ti-204.112
14	ST-203.014	ST-204.014	Ti-203.114	Ti-204.114
16	ST-203.016	ST-204.016	Ti-203.116	Ti-204.116
18	ST-203.018	ST-204.018	Ti-203.118	Ti-204.118
20	ST-203.020	ST-204.020	Ti-203.120	Ti-204.120
22	ST-203.022	ST-204.022	Ti-203.122	Ti-204.122
24	ST-203.024	ST-204.024	Ti-203.124	Ti-204.124
26	ST-203.026	ST-204.026	Ti-203.126	Ti-204.126
28	ST-203.028	ST-204.028	Ti-203.128	Ti-204.128
30	ST-203.030	ST-204.030	Ti-203.130	Ti-204.130
32	ST-203.032	ST-204.032	Ti-203.132	Ti-204.132
34	ST-203.034	ST-204.034	Ti-203.134	Ti-204.134
36	ST-203.036	ST-204.036	Ti-203.136	Ti-204.136
38	ST-203.038	ST-204.038	Ti-203.138	Ti-204.138
40	ST-203.040	ST-204.040	Ti-203.140	Ti-204.140
42	ST-203.042	ST-204.042	Ti-203.142	Ti-204.142
44	ST-203.044	ST-204.044	Ti-203.144	Ti-204.144
46	ST-203.046	ST-204.046	Ti-203.146	Ti-204.146
48	ST-203.048	ST-204.048	Ti-203.148	Ti-204.148
50	ST-203.050	ST-204.050	Ti-203.150	Ti-204.150

Drill Bit: 2.7mm  
Drill Bit for Gliding Hole: 3.5mm

### CORTEX CANNULATED SCREW Ø 3.5MM FULL THREAD

Length in mm	Standard S.S.	Self Tapping S.S.	Standard Titanium	Self Tapping Titanium
10	ST-205.010	ST-206.010	Ti-205.210	Ti-206.210
12	ST-205.012	ST-206.012	Ti-205.212	Ti-206.212
14	ST-205.014	ST-206.014	Ti-205.214	Ti-206.214
16	ST-205.016	ST-206.016	Ti-205.216	Ti-206.216
18	ST-205.018	ST-206.018	Ti-205.218	Ti-206.218
20	ST-205.020	ST-206.020	Ti-205.220	Ti-206.220
22	ST-205.022	ST-206.022	Ti-205.222	Ti-206.222
24	ST-205.024	ST-206.024	Ti-205.224	Ti-206.224
26	ST-205.026	ST-206.026	Ti-205.226	Ti-206.226
28	ST-205.028	ST-206.028	Ti-205.228	Ti-206.228
30	ST-205.030	ST-206.030	Ti-205.230	Ti-206.230
32	ST-205.032	ST-206.032	Ti-205.232	Ti-206.232
34	ST-205.034	ST-206.034	Ti-205.234	Ti-206.234
36	ST-205.036	ST-206.036	Ti-205.236	Ti-206.236
38	ST-205.038	ST-206.038	Ti-205.238	Ti-206.238
40	ST-205.040	ST-206.040	Ti-205.240	Ti-206.240
42	ST-205.042	ST-206.042	Ti-205.242	Ti-206.242
44	ST-205.044	ST-206.044	Ti-205.244	Ti-206.244
46	ST-205.046	ST-206.046	Ti-205.246	Ti-206.246
48	ST-205.048	ST-206.048	Ti-205.248	Ti-206.248
50	ST-205.050	ST-206.050	Ti-205.250	Ti-206.250

Drill Bit: 2.7mm  
Drill Bit for Gliding Hole: 3.5mm

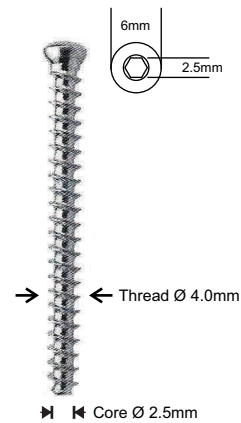
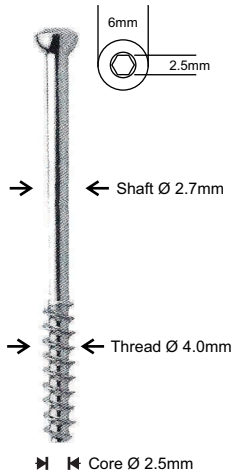
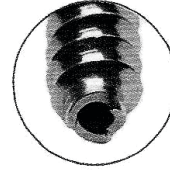
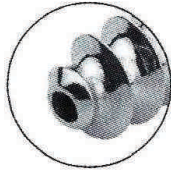

**CANNULATED CANCELLOUS SCREW Ø 4.0MM  
SHORT THREAD**

Length in mm	Standard S.S.	Self Tapping S.S.	Standard Titanium	Self Tapping Titanium
10	ST-181.010	ST-182.010	Ti-181.010	Ti-182.310
12	ST-181.012	ST-182.012	Ti-181.012	Ti-182.312
14	ST-181.014	ST-182.014	Ti-181.014	Ti-182.314
16	ST-181.016	ST-182.016	Ti-181.016	Ti-182.316
18	ST-181.018	ST-182.018	Ti-181.018	Ti-182.318
20	ST-181.020	ST-182.020	Ti-181.020	Ti-182.320
22	ST-181.022	ST-182.022	Ti-181.022	Ti-182.322
24	ST-181.024	ST-182.024	Ti-181.024	Ti-182.324
26	ST-181.026	ST-182.026	Ti-181.026	Ti-182.326
28	ST-181.028	ST-182.028	Ti-181.028	Ti-182.328
30	ST-181.030	ST-182.030	Ti-181.030	Ti-182.330
32	ST-181.032	ST-182.032	Ti-181.032	Ti-182.332
34	ST-181.034	ST-182.034	Ti-181.034	Ti-182.334
36	ST-181.036	ST-182.036	Ti-181.036	Ti-182.336
38	ST-181.038	ST-182.038	Ti-181.038	Ti-182.338
40	ST-181.040	ST-182.040	Ti-181.040	Ti-182.340
42	ST-181.042	ST-182.042	Ti-181.042	Ti-182.342
44	ST-181.044	ST-182.044	Ti-181.044	Ti-182.344
46	ST-181.046	ST-182.046	Ti-181.046	Ti-182.346
48	ST-181.048	ST-182.048	Ti-181.048	Ti-182.348
50	ST-181.050	ST-182.050	Ti-181.050	Ti-182.350
55	ST-181.055	ST-182.055	Ti-181.055	Ti-182.355
60	ST-181.060	ST-182.060	Ti-181.060	Ti-182.360

Drill Bit: 2.7mm

**CANNULATED CANCELLOUS SCREW Ø 4.0MM  
FULL THREAD**

Length in mm	Standard S.S.	Self Tapping S.S.	Standard Titanium	Self Tapping Titanium
10	ST-183.010	ST-184.010	Ti-183.210	Ti-184.410
12	ST-183.012	ST-184.012	Ti-183.212	Ti-184.412
14	ST-183.014	ST-184.014	Ti-183.214	Ti-184.414
16	ST-183.016	ST-184.016	Ti-183.216	Ti-184.416
18	ST-183.018	ST-184.018	Ti-183.218	Ti-184.418
20	ST-183.020	ST-184.020	Ti-183.220	Ti-184.420
22	ST-183.022	ST-184.022	Ti-183.222	Ti-184.422
24	ST-183.024	ST-184.024	Ti-183.224	Ti-184.424
26	ST-183.026	ST-184.026	Ti-183.226	Ti-184.426
28	ST-183.028	ST-184.028	Ti-183.228	Ti-184.428
30	ST-183.030	ST-184.030	Ti-183.230	Ti-184.430
32	ST-183.032	ST-184.032	Ti-183.232	Ti-184.432
34	ST-183.034	ST-184.034	Ti-183.234	Ti-184.434
36	ST-183.036	ST-184.036	Ti-183.236	Ti-184.436
38	ST-183.038	ST-184.038	Ti-183.238	Ti-184.438
40	ST-183.040	ST-184.040	Ti-183.240	Ti-184.440
42	ST-183.042	ST-184.042	Ti-183.242	Ti-184.442
44	ST-183.044	ST-184.044	Ti-183.244	Ti-184.444
46	ST-183.046	ST-184.046	Ti-183.246	Ti-184.446
48	ST-183.048	ST-184.048	Ti-183.248	Ti-184.448
50	ST-183.050	ST-184.050	Ti-183.250	Ti-184.450
55	ST-183.055	ST-184.055	Ti-183.255	Ti-184.455
60	ST-183.060	ST-184.060	Ti-183.260	Ti-184.460

Drill Bit: 2.7mm

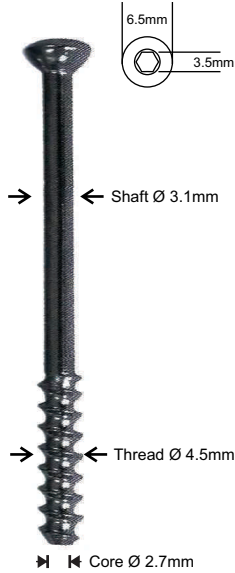
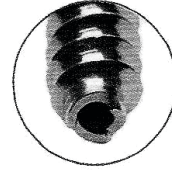
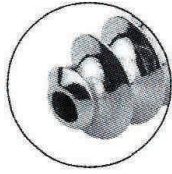

**CORTEX CANCELLOUS SCREW Ø 4.5MM  
SHORT THREAD**

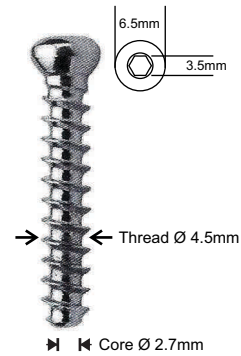

**CORTEX CANCELLOUS SCREW Ø 4.5MM  
FULL THREAD**

Length in mm	Standard S.S.	Self Tapping S.S.	Standard Titanium	Self Tapping Titanium
22	ST-115.022	ST-116.022	Ti-115.122	Ti-116.322
24	ST-115.024	ST-116.024	Ti-115.124	Ti-116.324
26	ST-115.026	ST-116.026	Ti-115.126	Ti-116.326
28	ST-115.028	ST-116.028	Ti-115.128	Ti-116.328
30	ST-115.030	ST-116.030	Ti-115.130	Ti-116.330
32	ST-115.032	ST-116.032	Ti-115.132	Ti-116.332
34	ST-115.034	ST-116.034	Ti-115.134	Ti-116.334
36	ST-115.036	ST-116.036	Ti-115.136	Ti-116.336
38	ST-115.038	ST-116.038	Ti-115.138	Ti-116.338
40	ST-115.040	ST-116.040	Ti-115.140	Ti-116.340
42	ST-115.042	ST-116.042	Ti-115.142	Ti-116.342
44	ST-115.044	ST-116.044	Ti-115.144	Ti-116.344
46	ST-115.046	ST-116.046	Ti-115.146	Ti-116.346
48	ST-115.048	ST-116.048	Ti-115.148	Ti-116.348
50	ST-115.050	ST-116.050	Ti-115.150	Ti-116.350
52	ST-115.052	ST-116.052	Ti-115.152	Ti-116.352
54	ST-115.054	ST-116.054	Ti-115.154	Ti-116.354
56	ST-115.056	ST-116.056	Ti-115.156	Ti-116.356
58	ST-115.058	ST-116.058	Ti-115.158	Ti-116.358
60	ST-115.060	ST-116.060	Ti-115.160	Ti-116.360
62	ST-115.062	ST-116.062	Ti-115.162	Ti-116.362
64	ST-115.064	ST-116.064	Ti-115.164	Ti-116.364
66	ST-115.066	ST-116.066	Ti-115.166	Ti-116.366
68	ST-115.068	ST-116.068	Ti-115.168	Ti-116.368
70	ST-115.070	ST-116.070	Ti-115.170	Ti-116.370
72	ST-115.072	ST-116.072	Ti-115.172	Ti-116.372
74	ST-115.074	ST-116.074	Ti-115.174	Ti-116.374

Drill Bit: 3.2mm  
Drill Bit for Gliding Hole: 4.5mm

Length in mm	Standard S.S.	Self Tapping S.S.	Standard Titanium	Self Tapping Titanium
22	ST-117.022	ST-118.022	Ti-117.022	Ti-118.222
24	ST-117.024	ST-118.024	Ti-117.024	Ti-118.224
26	ST-117.026	ST-118.026	Ti-117.026	Ti-118.226
28	ST-117.028	ST-118.028	Ti-117.028	Ti-118.228
30	ST-117.030	ST-118.030	Ti-117.030	Ti-118.230
32	ST-117.032	ST-118.032	Ti-117.032	Ti-118.232
34	ST-117.034	ST-118.034	Ti-117.034	Ti-118.234
36	ST-117.036	ST-118.036	Ti-117.036	Ti-118.236
38	ST-117.038	ST-118.038	Ti-117.038	Ti-118.238
40	ST-117.040	ST-118.040	Ti-117.040	Ti-118.240
42	ST-117.042	ST-118.042	Ti-117.042	Ti-118.242
44	ST-117.044	ST-118.044	Ti-117.044	Ti-118.244
46	ST-117.046	ST-118.046	Ti-117.046	Ti-118.246
48	ST-117.048	ST-118.048	Ti-117.048	Ti-118.248
50	ST-117.050	ST-118.050	Ti-117.050	Ti-118.250
52	ST-117.052	ST-118.052	Ti-117.052	Ti-118.252
54	ST-117.054	ST-118.054	Ti-117.054	Ti-118.254
56	ST-117.056	ST-118.056	Ti-117.056	Ti-118.256
58	ST-117.058	ST-118.058	Ti-117.058	Ti-118.258
60	ST-117.060	ST-118.060	Ti-117.060	Ti-118.260
62	ST-117.062	ST-118.062	Ti-117.062	Ti-118.262
64	ST-117.064	ST-118.064	Ti-117.064	Ti-118.264
66	ST-117.066	ST-118.066	Ti-117.066	Ti-118.266
68	ST-117.068	ST-118.068	Ti-117.068	Ti-118.268
70	ST-117.070	ST-118.070	Ti-117.070	Ti-118.270
72	ST-117.072	ST-118.072	Ti-117.072	Ti-118.272
74	ST-117.074	ST-118.074	Ti-117.074	Ti-118.274

Drill Bit: 3.2mm  
Drill Bit for Gliding Hole: 4.5mm



**SHANZ SCREWS  
( FRONT THREADED PIN )  
STAINLESS STEEL**

Diameter 2.0mm	Diameter in mm	Length in mm	Thread in mm
ST-351.001	4.0	125	18
ST-351.002	4.0	175	25
ST-351.005	4.5	150	18
ST-351.006	4.5	150	25
ST-351.007	4.5	175	18
ST-351.008	4.5	175	25
ST-351.009	4.5	175	32
ST-351.010	4.5	175	40
ST-351.011	4.5	200	25
ST-351.012	4.5	200	32
ST-351.013	4.5	200	40
ST-351.014	4.5	225	25
ST-351.015	4.5	225	32
ST-351.016	4.5	225	40
ST-351.025	5.0	150	18
ST-351.026	5.0	150	25
ST-351.027	5.0	175	18
ST-351.028	5.0	175	25
ST-351.029	5.0	175	32
ST-351.030	5.0	175	40
ST-351.031	5.0	200	25
ST-351.032	5.0	200	32
ST-351.033	5.0	200	40
ST-351.034	5.0	225	25
ST-351.035	5.0	225	32
ST-351.036	5.0	225	40
ST-351.037	6.0	225	32
ST-351.038	6.0	225	40

**AccuMed<sup>®</sup>**



<http://accumedinstrument.com>

## **Orthopedic Implants & Instruments**

**Orthopedic Implants & Instruments**  
**Opp. Shell Petrol Pump, Wazirabad Road.,**  
**Ugoki, Sialkot. Pakistan**